

KICHLER®



PROFESSIONAL LIGHTING  
SOLUTIONS



All the  
support  
you need.

From corridors to common areas, you need light fixtures you can trust; fixtures that stand up to time, traffic and everyday wear and tear. With Kichler® products, we support your project's success every step of the way—from localized service, to inventory and on-time delivery.



# Navigating the Catalog

## Search by Category

The Professional Lighting Solutions Catalog presents select Kichler® and élan® fixtures by product category. From Indoor Ceiling and Wall fixtures like Downlights, Pendants, and Sconces, to LED Tape, Ceiling Fans and Outdoor product, the pages that follow are designed to help narrow your search to exactly what you need.

**Want full lighting collections for room-to-room coordination? A sampling of lighting collections can be found on pages 70-83.**



## Additional LED Options

Kichler Lighting offers a selection of fixtures that come packaged with compatible LED bulbs included. Bundled together, the Product + Bulbs are Energy Star® rated. These LED options are denoted with “L18” in the model number, and typically appear just after the integrated LED options in each section.

**To learn more about L18, see page 24.**

## Locate LED

You will find integrated LED fixtures at the beginning of each product category. Many of these fixtures were designed for 24/7-use and are in compliance with the latest Energy Star® and Title 24 standards.

Look for these icons throughout the charts  

## Back to the Basics

This catalog also presents a broad selection of our top, tried-and-true incandescent and fluorescent fixtures—featured just after our LED options in each product category.

**Want to see more? For the full assortment of Kichler Decorative, Ceiling Fans, Lighting Systems and Landscape products, visit [Kichler.com](http://Kichler.com) and find:**

- Full-line catalogs
- Spec and data sheets
- Videos
- IES files
- Product reviews, and more!

# Table of Contents



## Indoor Lighting

- 14 Downlights
- 16 Ceiling
- 32 Wall Sconces
- 40 Vanity
- 56 Pendants
- 70 Lighting Collections

## Cabinet Lighting

- 86 LED
- 89 Fluorescent

## LED Tape & Accent Lighting

- 92 Tape 12V, 24V Dry, Damp & RGB
- 98 Accent Discs 12V, 24V
- 99 Hardstrips 24V
- 101 Power Supplies & Accessories

## LED Step & Hall Lighting

- 114 LED Step & Hall

## Ceiling Fans

- 118 Indoor
- 126 Outdoor
- 129 Accessories

## Outdoor Lighting

- 132 LED
- 139 Fluorescent/Incandescent
- 156 Commercial Outdoor Ceiling & Wall

## Commercial Outdoor/Landscape Lighting

- 162 Line Voltage
- 180 12V Integrated LED & Retrofit
- 201 Transformers
- 202 12V Accessories

## 206 Regulatory Information

## 212 Index

# With Kichler® Products, You Get Quality Fixtures And So Much More:

## Always ready.

Whether you need volume and variety for a multi-family structure, or style and efficiency for the high-use needs of a hotel or restaurant, Kichler Lighting offers solutions that perform through it all. Our integrated LED fixtures are designed for 24/7 operation and feature dependable materials like rust-resistant cast aluminum housings, durable acrylic or polycarbonate diffusers, and sturdy powder coated finishes. With Kichler products you'll always get:

- High-quality integrated LED fixtures that have been tested and re-tested to ensure they will withstand the test of time
- Additional LED options on select fixtures that feature Energy Star® rated LED bulbs enclosed within (see page 24 to learn more about our L18 offering)
- Products designed for Energy Star Certification and T24 ratings to help you earn rebates and LEED points as well as keep energy costs in check
- New opportunities for projects requiring universal voltage (120V-277V) sconces, vanity or outdoor fixtures, all available from Kichler.
- Commercial-grade outdoor products that are DLC qualified (see page 162 for our C-series fixtures)
- Options to suit a variety of kelvin, CRI and lumen output requirements

For more information on Energy Star, Title 24, DLC and more, see pages 206-209.

*In-house Integrating Sphere measures total lumens, lumens per watt (LPW), color temp (CCT) and color rendering index (CRI)*



## Always available.

With over 1 million square feet dedicated to distribution, we are well stocked with the products you'll use most:

- We ship product on your timetable – even as quickly as 24 hours
- Our orders ship with 99.85% accuracy and 95%+ fill rate

Our three distribution centers are strategically located across the country to help expedite shipping and keep costs in check:

- Cleveland, OH (headquarters)
- Atlanta, GA
- Las Vegas, NV



Racks stocked high with inventory to fulfill your project needs.





## Always behind you.

Whether in the field, over the phone or online, Kichler Lighting offers service and support second to none:

- Domestically based call center is staffed with team members that have an average of 14 years of experience with Kichler Lighting
- In-field representatives offer local, personalized attention and service
- Web-based access to IES files, videos and more
- Kichler Lighting also offers FREE Layout Design and Tech support through our **Advanced Product Solutions (APS) & Layout team**



# Advanced Product Solutions (APS) & Layout

## Free layout and design services—and so much more.

From answering questions to creating detailed layouts to delivering a full bill of materials (BOM) – the Kichler Lighting APS & Layout team is your link to getting the job done. This free service takes the guesswork out of any lighting need you have: determining the scope of materials required, recommending dimmers and even creating a full wiring and product layout.

### Layout Design Services

Get to solutions faster and increase sales.

From choosing landscape lighting to maximizing a kitchen's functionality; from outfitting a restaurant with lighting to coordinating lighting throughout a home—these are just a few of the jobs our APS & Layout team can get done for you.

Contact us at [layouts@kichler.com](mailto:layouts@kichler.com) and we'll get you started:

- 1 Email us a completed Design Request Form (available at [Kichler.com/APS](http://Kichler.com/APS)) along with any drawings or pictures related to the job.
- 2 We'll create a BOM and email it back to you that same day (for all requests received by 3 pm EST).
- 3 Once you confirm the BOM and pricing, we'll return a completed layout design within 48 hours or less.

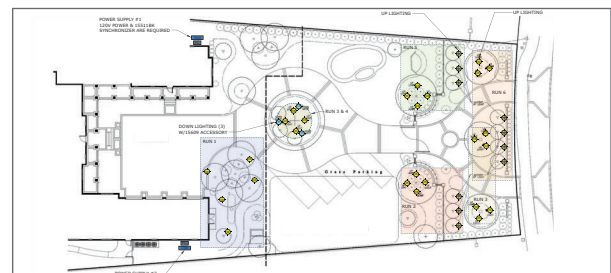
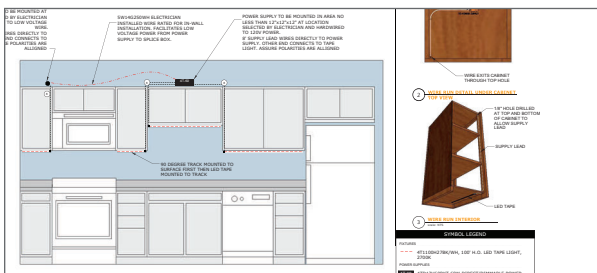

### Advanced Product Support

No question is too complex.

Installation issue? Building code question? Regulatory stumper? If you've got a challenging question—we've got you covered. Our Advanced Product Support team received additional classroom and in-field training on all Kichler® products, so you can get your question answered quickly. To take advantage of this free service, call our dedicated Advanced Product Support line at **844-KICHLER (844-542-4537)** or email [techsupport@kichler.com](mailto:techsupport@kichler.com).

# Lighting Solutions For Work, Dine, Play And Stay

## Always what you need.

With Kichler Lighting you know you'll get breadth of style – but did you know that's just the beginning of what we offer? For more than 75 years, we've built a reputation as a leader in designing, manufacturing and standing behind all types of lighting fixtures, including fixtures for:

- Multi-family, single family, and senior living spaces
- Hotel rooms, common areas, and hallways
- Ambient and functional restaurant lighting
- Office reception areas, break and conference rooms, and work spaces



From left to right and top to bottom: élan® Wall Sconce 83757NI, Bathroom: 1254NILED; Restaurant: 11252NILED; Conference Room: 10789NILED, 4D12V27WHT; Apartment: 43670NI, 45572NI, 43846WHLED30, 4U30K12BZT; Hallway: 10784NILED, 10790NILED; Reception: 44249NILED40, 6T1100H27BK



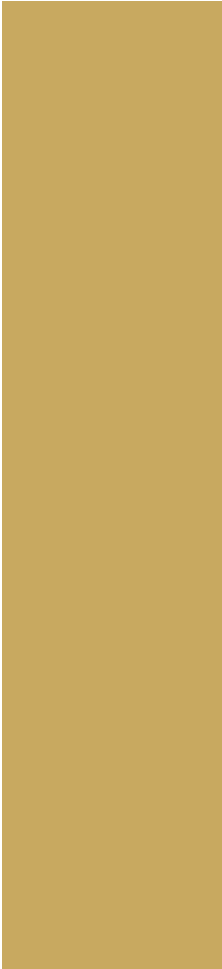

## Indoor Lighting

**Downlights** page 14

**Ceiling** page 16

**Wall Sconces** page 32

**Vanity** page 40

**Pendants** page 56

**Lighting Collections** page 70

In a professional environment, the right ceiling or wall lighting should complement the functional needs of the space. For instance, broad, bright ceiling fixtures work to increase productivity in an office. Staggered sconces along a corridor offer tenants a sense of security in finding their way. A pattern of downlights around the perimeter of any room offers a complete corner-to-corner lighting effect for full-room coverage. When it comes to finding the right light for your application, Kichler Lighting products deliver results.

Want to see more? For an expanded selection of interior fixtures, visit [KichlerPro.com](http://KichlerPro.com)



Polycarbonate Diffuser



**A** 43855 WHLED30T

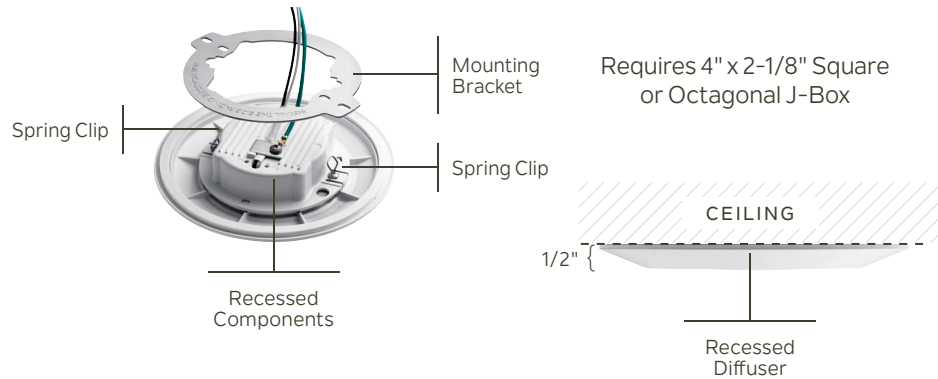

Glass Diffuser



**B** 43870 WHLED27  
43870 WHLED27B  
43870 WHLED30  
43870 WHLED30B

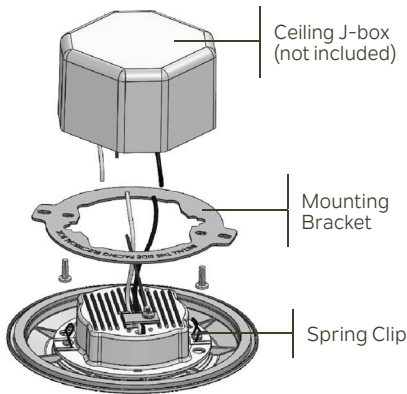
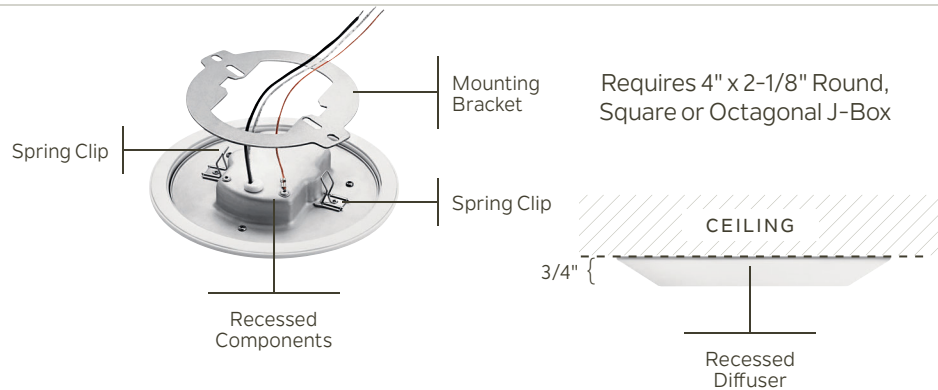

## Horizon LED Downlights

Ideal for new construction when specified with a 4" wide x 2-1/8" deep junction box (J-box shape varies per item)

Offers the sleek, hidden appeal of a recessed fixture with its slender profile

Well-dispersed, ambient lighting

Single fixture to order, track and install

ITEM #	FINISH	LIGHT SOURCE	LED FIXTURE OUTPUT	DIMENSIONS	HCWO	NOTES
<b>A</b> 43855	WHLED30T	(1) 12.5W	3000K, 90 CRI, 850 Lumens, 68 LPW	6.5W x 1.25H	3.25	Dimmable. Wet indoor ceiling, damp indoor wall. JA-8 compliant.
<b>B</b> 43870	WHLED27, WHLED27B, WHLED30, WHLED30B	(1) 12.5W	2700K, 90 CRI, 850 Lumens, 68 LPW 3000K, 90 CRI, 850 Lumens, 68 LPW	6.5W x 1.25H	3.25	Dimmable. Wet indoor ceiling, damp indoor wall, damp outdoor ceiling. Item number with "B" signifies 24 count bulk pack.

Measurements shown in inches.

**Wet/Damp Ratings:** Kichler® downlights are Wet rated for indoor ceiling applications like showers. When considering outdoor or wall applications, follow Damp guidelines (under eave, or away from direct contact with elements) as recommended in the above chart.

For the most up to date specs, wet/damp ratings, and additional color temperatures, visit [Kichler.com](http://Kichler.com).



## Low Profile LED Downlights

Rests flush against the ceiling

J-box installation for new construction

Retrofit kit available for installation over existing recessed housings

GEN 2 Polycarbonate Diffuser



D

43848 NILED27, NILED27T  
43848 OZLED27, OZLED27T  
43848 WHLED27, WHLED27T, WHLED27TB

Polycarbonate Diffuser



E

43848 NILED30, NILED30T  
43848 OZLED30, OZLED30T  
43848 WHLED30, WHLED30T, WHLED30TB

GEN 1 Polycarbonate Diffuser



F

43846 WHLED27  
43846 WHLED27B

Polycarbonate Diffuser



G

43846 WHLED30  
43846 WHLED30B

Retrofit Kit for 43846, 43848

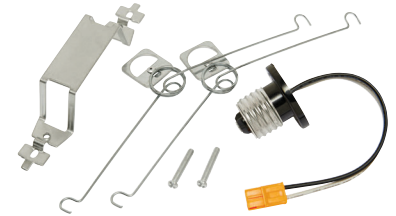

4146LED

SMALL Polycarbonate Diffuser



H

43878 WHLED27

Polycarbonate Diffuser



I

43878 WHLED30

Retrofit Kit for 43878

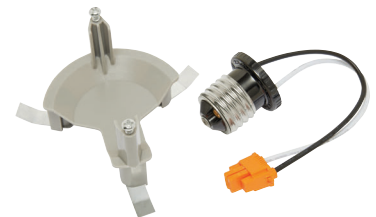

4145LED

ITEM #	FINISH	LIGHT SOURCE	LED FIXTURE OUTPUT	DIMENSIONS	HCWO	NOTES
D 43848	NILED27, OZLED27 WHLED27, NILED27T, OZLED27T, WHLED27T, WHLED27TB	(1) 15W	2700K, 90 CRI, 950 Lumens, 63 LPW	7.5W x 1.25H	3.75	Dimmable. Wet indoor ceiling, damp indoor wall.  Items ending in T signify Title 24. Item number with "B" signifies 24 count bulk pack.
E 43848	NILED30, OZLED30, WHLED30, NILED30T, OZLED30T, WHLED30T, WHLED30TB	(1) 15W	3000K, 90 CRI, 1000 Lumens, 67 LPW	7.5W x 1.25H	3.75	Dimmable. Wet indoor ceiling, damp indoor wall.  Items ending in T signify Title 24. Item number with "B" signifies 24 count bulk pack.
F 43846	WHLED27, WHLED27B	(1) 15W	2700K, 90 CRI, 850 Lumens, 57 LPW	7.5W x 1.25H	3.75	Dimmable. Wet indoor ceiling, damp indoor wall. Item number with "B" signifies 24 count bulk pack.
G 43846	WHLED30, WHLED30B	(1) 15W	3000K, 90 CRI, 850 Lumens, 57 LPW	7.5W x 1.25H	3.75	Dimmable. Wet indoor ceiling, damp indoor wall. Item number with "B" signifies 24 count bulk pack.
H 43878	WHLED27	(1) 11.5W	2700K, 90 CRI, 600 Lumens, 54 LPW	6W x 1.25H	4.45	Dimmable. Wet indoor ceiling, damp indoor wall, damp outdoor ceiling.
I 43878	WHLED30	(1) 11.5W	3000K, 90 CRI, 600 Lumens, 54 LPW	6W x 1.25H	3	Dimmable. Wet indoor ceiling, damp indoor wall, damp outdoor ceiling.

Adorn offices, lobbies and common areas with the edge-to-edge lighting effect of the Zeo family of fixtures.

Edge-lit technology completely fills the diffuser with even light – no unsightly dark edges

Mounting plate allows for simple J-box installation

High-transmission acrylic diffuser for maximum light distribution

Broad array of sizes, shapes and finishes to suit the application at hand with durable, ABS trim



ITEM #	FINISH	LIGHT SOURCE	LED FIXTURE OUTPUT	DIMENSIONS	HCWO	NOTES
A	44244 NILED30, WHLED30	14.5W	3000K, 90 CRI, 820 Lumens, 57 LPW	7W x 1H	3.5	Dimmable. NI plated ABS trim. WH ABS trim. Wet indoor ceiling.
B	44244 NILED40, WHLED40	14.5W	4000K, 90 CRI, 820 Lumens, 57 LPW	7W x 1H	3.5	Dimmable. NI plated ABS trim. WH ABS trim. Wet indoor ceiling.
C	44245 NILED30, WHLED30	14.5W	3000K, 90 CRI, 820 Lumens, 57 LPW	7W x 1H	3.5	Dimmable. NI plated ABS trim. WH ABS trim. Wet indoor ceiling.
D	44245 NILED40, WHLED40	14.5W	4000K, 90 CRI, 820 Lumens, 57 LPW	7W x 1H	3.5	Dimmable. NI plated ABS trim. WH ABS trim. Wet indoor ceiling.
E	44246 NILED30, WHLED30	18.5W	3000K, 90 CRI, 1100 Lumens, 59 LPW	10W x 1H	5	Dimmable. NI plated ABS trim. WH ABS trim. Damp rated indoor only.
F	44246 NILED40, WHLED40	18.5W	4000K, 90 CRI, 1100 Lumens, 59 LPW	10W x 1H	5	Dimmable. NI plated ABS trim. WH ABS trim. Damp rated indoor only.

Measurements shown in inches.

**Wet/Damp Ratings:** Kichler® downlights are Wet rated for indoor ceiling applications like showers. When considering outdoor or wall applications, follow Damp guidelines (under eave, or away from direct contact with elements) as recommended in the above chart.

= ADA Compliant = DAMP = WET = Dark Sky Compliant = LED Integrated = Lamp Included = CFL Lamp Included = LED Bulb Included



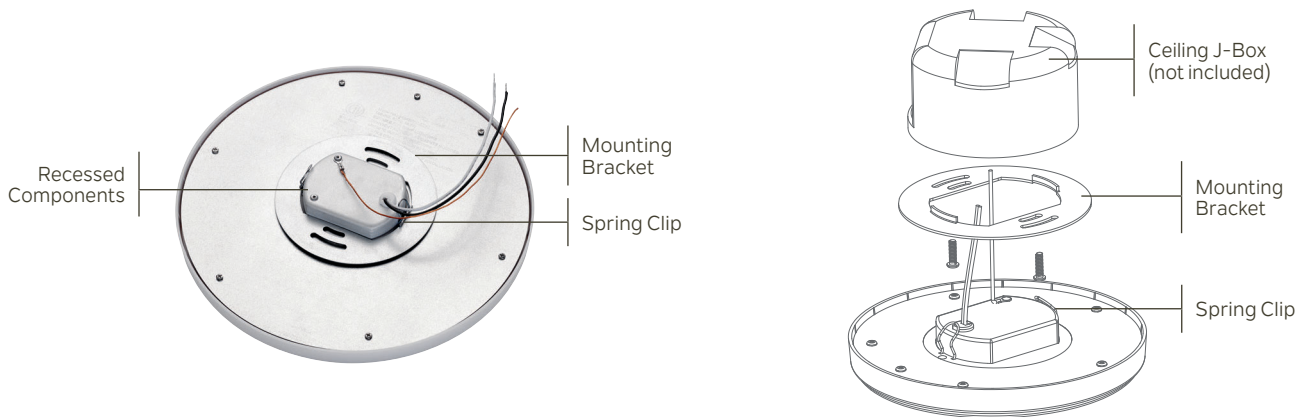

ITEM #	FINISH	LIGHT SOURCE	LED FIXTURE OUTPUT	DIMENSIONS	HCWO	NOTES
<b>G</b> 44247	NILED30, WHLED30	18.5W	3000K, 90 CRI, 1100 Lumens, 59 LPW	10W x 1H	5	Dimmable. NI plated ABS trim. WH ABS trim. Damp rated indoor only.
<b>H</b> 44247	NILED40, WHLED40	18.5W	4000K, 90 CRI, 1100 Lumens, 59 LPW	10W x 1H	5	Dimmable. NI plated ABS trim. WH ABS trim. Damp rated indoor only.
<b>I</b> 44248	NILED30, WHLED30	24W	3000K, 90 CRI, 1500 Lumens, 62 LPW	13W x 1H	6.5	Dimmable. NI plated ABS trim. WH ABS trim. Damp rated indoor only.
<b>J</b> 44248	NILED40, WHLED40	24W	4000K, 90 CRI, 1500 Lumens, 62 LPW	13W x 1H	6.5	Dimmable. NI plated ABS trim. WH ABS trim. Damp rated indoor only.
<b>K</b> 44249	NILED30, WHLED30	24W	3000K, 90 CRI, 1500 Lumens, 62 LPW	13W x 1H	6.5	Dimmable. NI plated ABS trim. WH ABS trim. Damp rated indoor only.
<b>L</b> 44249	NILED40, WHLED40	24W	4000K, 90 CRI, 1500 Lumens, 62 LPW	13W x 1H	6.5	Dimmable. NI plated ABS trim. WH ABS trim. Damp rated indoor only.

Measurements shown in inches.



## élan® LED Lighting. The Passion of Art. The Beauty of Light.

The élan brand creates an elegant focal point within a variety of spaces, including modern hotels, architectural office towers, destination dining or high-end homes

Each uniquely modern fixture delivers an artistic interpretation of leading design trends, yet is backed by Kichler Lighting's commitment to quality and an extensive support network

The collection uses only high-end materials and distinctive finishes

For additional style and finish options, visit [élan-lighting.com](http://élan-lighting.com) or contact your local Kichler® sales representative

Press Glass with White Inside



A | 83803 NI

Press Glass with White Inside



B | 83806 BZ

Press Glass with White Inside



C | 83799 NI

Press Glass with White Inside



D | 83802 BZ

	ITEM #	FINISH	LIGHT SOURCE	LED FIXTURE OUTPUT	DIMENSIONS	NOTES
A	83803	NI	30W	3000K, 90 CRI, 1270 Lumens, 42 LPW	11L x 11W x 2.5H	Dimmable.
B	83806	BZ	60W	3000K, 92 CRI, 2477 Lumens, 41 LPW	14L x 14W x 2.5H	Dimmable.
C	83799	NI	30W	3000K, 91 CRI, 507 Lumens, 50 LPW	9L x 9W x 2.75H	Dimmable.
D	83802	BZ	60W	3000K, 91 CRI, 2718 Lumens, 45 LPW	12L x 12W x 2.75H	Dimmable.

For additional style and finish options, visit [élan-lighting.com](http://élan-lighting.com), or contact your local sales representative.

Measurements shown in inches.

= ADA Compliant = DAMP = WET = Dark Sky Compliant = LED Integrated = Lamp Included = CFL Lamp Included = LED Bulb Included

**Kichler® LED lighting exceeds the standards for efficiency, reliability and beauty**

Long-life light emitting diodes (LED) provide approx. 40,000-hour life span to L70 (70% initial lumens) – about 5 years of standard operation

True optics: pure white light and controlled beam spread with no fade or drop off of light

High Color Rendering Index (CRI)

Standard installation



These devices comply with Part 15 of the FCC Regulations.

White Acrylic Diffuser



**A** | 10769 NILED  
10769 OZLED

White Acrylic Diffuser



**B** | 10784 NILED  
10784 OZLED

White Acrylic Diffuser



**C** | 10786 NILED  
10786 OZLED

White Acrylic Diffuser



**D** | 10788 NILED  
10788 OZLED

White Acrylic Diffuser



**E** | 10789 NILED  
10789 OZLED

Acrylic Applied Tint w/ Painted Linen



**F** | 11302 CPLED  
11302 NILED

ITEM #	FINISH	LIGHT SOURCE	LED FIXTURE OUTPUT	DIMENSIONS	EXT.	HCWO	NOTES
<b>A</b> 10769	NILED, OZLED	(1) 28.5W	3000K, 90 CRI, 1900 Lumens, 66 LPW	14W x 3.75H	4	7	Dimmable. Ceiling or wall mount.
<b>B</b> 10784	NILED, OZLED	(1) 23W	3000K, 90 CRI, 1280 Lumens, 56 LPW	11.75W x 3.5H	3.5	6	Dimmable. Ceiling or wall mount.
<b>C</b> 10786	NILED, OZLED	(1) 34W	3000K, 90 CRI, 1790 Lumens, 53 LPW	17.75W x 4.25H	4.25	8.75	Dimmable. Ceiling or wall mount.
<b>D</b> 10788	NILED, OZLED	(1) 48W	3000K, 90 CRI, 3725 Lumens, 78 LPW	24W x 4.75H	4.75	12	Dimmable. Ceiling or wall mount.
<b>E</b> 10789	NILED, OZLED	(1) 54W	3000K, 90 CRI, 3750 Lumens, 69 LPW	32.5L x 18W x 4.75H	4.75	9	Dimmable. Oval Shape. Ceiling or wall mount.
<b>F</b> 11302	CPLED, NILED	(1) 18.5W	3000K, 90 CRI, 1150 Lumens, 62 LPW	12W x 3.75H	---	---	Dimmable.

Measurements shown in inches. Delivered Lumens shown.



Acrylic Applied Tint with Painted Linen



**G** | 11303 CPLED  
11303 NILED

White Acrylic Diffuser with White Linen Trim



**H** | 10885 NILED

White Acrylic Diffuser with White Linen Trim



**I** | 10886 NILED

Etched Opal Glass



**J** | 42379 NILED  
42379 OZLEDR

Etched Opal Glass



**K** | 42380 NILED  
42380 OZLEDR

Clear Fresnel Lens



**L** | 43883 NILED  
43883 OZLEDR

White Acrylic Diffuser



**M** | 10763 NILED

White Acrylic Diffuser



**N** | 10764 NILED

White Acrylic Diffuser



**O** | 10765 NILED

	ITEM #	FINISH	LIGHT SOURCE	LED FIXTURE OUTPUT	DIMENSIONS	EXT.	HCWO	NOTES
<b>G</b>	11303	CPLED, NILED	(1) 28.5W	3000K, 90 CRI, 1800 Lumens, 63 LPW	15W x 4.5H	---	---	Dimmable.
<b>H</b>	10885	NILED	(1) 23W	3000K, 90 CRI 1070 Lumens, 47 LPW	13W x 4.25H	4.25	6.5	Dimmable. May be installed on wall or ceiling.
<b>I</b>	10886	NILED	(1) 34W	3000K, 90 CRI, 1500 Lumens, 44 LPW	17.25W x 4.25H	4.25	8.75	Dimmable. May be installed on wall or ceiling.
<b>J</b>	42379	NILED, OZLEDR	(1) 22W	3000K, 90 CRI, 1675 Lumens, 76 LPW	13.25W x 3.25H	---	---	
<b>K</b>	42380	NILED, OZLEDR	(1) 22W	3000K, 90 CRI, 1675 Lumens, 76 LPW	14W x 3.25H	---	---	
<b>L</b>	43883	NILED, OZLEDR	(1) 22W	3000K, 90 CRI, 1675 Lumens, 76 LPW	13.25W x 4.5H	---	---	
<b>M</b>	10763	NILED	(1) 15W	3000K, 90 CRI, 930 Lumens, 62 LPW	11.5W x 3H	3	5.75	Dimmable. May be installed on wall or ceiling.
<b>N</b>	10764	NILED	(1) 23W	3000K, 90 CRI, 1300 Lumens, 57 LPW	14.5W x 3.75H	3.75	7.25	Dimmable. May be installed on wall or ceiling.
<b>O</b>	10765	NILED	(1) 34W	3000K, 90 CRI, 1850 Lumens, 55 LPW	17.75W x 4.5H	4.5	8.75	Dimmable. May be installed on wall or ceiling.

Delivered Lumens shown. Measurements shown in inches.

White Acrylic Diffuser



**A** | 10766 WHLED

White Acrylic Diffuser



**B** | 10767 WHLED

White Acrylic Diffuser



**C** | 10768 WHLED

White Acrylic Diffuser



**D** | 10755 WHLED

White Acrylic Diffuser



**E** | 10760 WHLED

White Acrylic Diffuser



**F** | 10761 WHLED

Satin Etched Glass



**G** | 8112 NILED  
8112 OZLEDR

Satin Etched Glass



**H** | 8116 NILED  
8116 OZLEDR

ITEM #	FINISH	LIGHT SOURCE	LED FIXTURE OUTPUT	DIMENSIONS	EXT.	HCWO	NOTES
A	10766 WHLED	(1) 15W	3000K, 90 CRI, 1080 Lumens, 72 LPW	10.75W x 3.75H	3.75	5.5	Dimmable. May be installed on wall or ceiling.
B	10767 WHLED	(1) 20W	3000K, 90 CRI, 1450 Lumens, 73 LPW	13.5W x 3.75H	3.75	6.75	Dimmable. May be installed on wall or ceiling.
C	10768 WHLED	(1) 25W	3000K, 90 CRI, 1850 Lumens, 74 LPW	16W x 3.75H	3.75	8	Dimmable. May be installed on wall or ceiling.
D	10755 WHLED	(1) 15W	3000K, 90 CRI, 1080 Lumens, 72 LPW	10.75W x 4H	4	5.5	Dimmable. May be installed on wall or ceiling.
E	10760 WHLED	(1) 20W	3000K, 90 CRI, 1470 Lumens, 74 LPW	14W x 4H	4	6.75	Dimmable. May be installed on wall or ceiling.
F	10761 WHLED	(1) 25W	3000K, 90 CRI, 1850 Lumens, 74 LPW	16W x 4.25H	4.25	8	Dimmable. May be installed on wall or ceiling.
G	8112 NILED 8112 OZLEDR	(1) 22W	3000K, 90 CRI, 1250 Lumens, 56 LPW	13.25W x 6H	---	---	Dimmable.
H	8116 NILED 8116 OZLEDR	(1) 22W	3000K, 90 CRI, 1350 Lumens, 61 LPW	15.25W x 6.5H	---	---	Dimmable.

Measurements shown in inches.

= ADA Compliant = DAMP = WET = Dark Sky Compliant = LED Integrated = Lamp Included = CFL Lamp Included = LED Bulb Included



White Acrylic Diffuser



**I** | 10301 WH  
10301 WHLED

White Acrylic Diffuser



**J** | 10303 WH  
10303 WHLED

## Energy saving options

Select ceiling pieces are also offered with a fluorescent light source.

White Acrylic Diffuser



**K** | 11304 NILED

Clear Prismatic Acrylic



**L** | 10315 WH  
10315 WHLED

White Polycarbonate



**M** | 11131 AZTLED

White Polycarbonate



**N** | 11132 AZTLED

White Polycarbonate



**O** | 11134 AZTLED

White Polycarbonate



**P** | 11135 AZTLED

ITEM #	FINISH	LIGHT SOURCE	LED FIXTURE OUTPUT	DIMENSIONS	EXT.	HCWO	NOTES
I 10301	WH	(2) 32W (BIPI) ❖	---	11.25W x 4.75H x 51.5L	---	---	ⓓ Ⓜ
I 10301	WHLED	(1) 61W Ⓜ ⓓ	3000K, 90 CRI, 4350 Lumens, 71 LPW	10.25W x 3.25H x 51L	---	---	ⓓ Ⓜ Dimmable.
J 10303	WH	(4) 32W (BIPI) ❖	---	16.75W x 5H x 51.5L	---	---	ⓓ Ⓜ
J 10303	WHLED	(1) 80W Ⓜ ⓓ	3000K, 90 CRI, 5725 Lumens, 71 LPW	16W x 3.25H x 51L	---	---	ⓓ Ⓜ Dimmable.
K 11304	NILED	(1) 55W Ⓜ ⓓ	3000K, 90 CRI, 3400 Lumens, 62 LPW	11.5W x 4.75H x 49.25L	---	---	ⓓ Ⓜ Dimmable. May be installed on wall or ceiling.
L 10315	WH	(2) 32W (BIPI) ❖	---	9W x 3H x 48L	---	---	ⓓ Ⓜ
L 10315	WHLED	(1) 39W Ⓜ ⓓ	3000K, 90 CRI, 2800 Lumens, 72 LPW	7.5W x 2.5H x 48L	---	---	ⓓ Ⓜ Dimmable.
M 11131	AZTLED	(1) 15W Ⓜ ⓓ	3000K, 90 CRI, 850 Lumens, 56 LPW	9W x 2.75H	2.75	4.5	Ⓜ ⓓ Ⓜ May be installed on wall or ceiling. Dimmable.
N 11132	AZTLED	(1) 23W Ⓜ ⓓ	3000K, 90 CRI, 1220 Lumens, 53 LPW	11W x 3H	3	5.5	Ⓜ ⓓ Ⓜ May be installed on wall or ceiling. Dimmable.
O 11134	AZTLED	(1) 15W Ⓜ ⓓ	3000K, 90 CRI, 740 Lumens, 49 LPW	9W x 3.25H	3.25	4.5	Ⓜ ⓓ Ⓜ May be installed on wall or ceiling. Dimmable.
P 11135	AZTLED	(1) 23W Ⓜ ⓓ	3000K, 90 CRI, 1060 Lumens, 46 LPW	11W x 3.5H	3.5	5.5	Ⓜ ⓓ Ⓜ May be installed on wall or ceiling. Dimmable.

Additional LED, Energy Star® Rated Fixtures—denoted with an “L18” in the model number—have Energy Star Rated LED light bulbs packaged with the fixture





The fixture is now Energy Star rated—delivering added value to your project and your customers

No separate orders, no searching around for bulbs, and no hassle

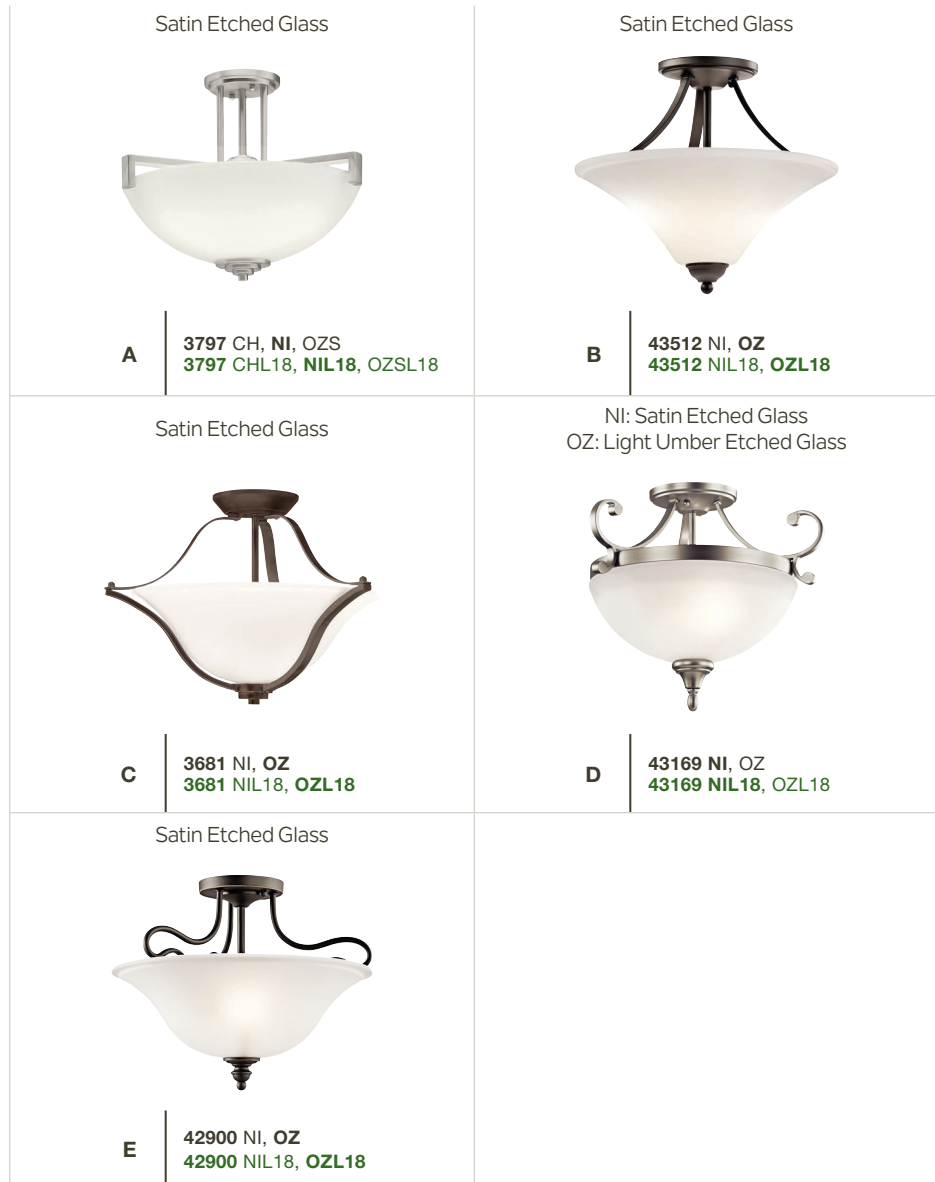
Compatible LED bulbs are included, so everything you need is in one box, ready for installation

For ease in locating these LED options, look for the icon 



ITEM #	FINISH	LIGHT SOURCE	LED BULB OUTPUT	DIMENSIONS	OVRLL. H	EXTRA WIRE	CHAIN/STEM	NOTES
A	3797 CH, NI, OZS	(3) 100W (M)	---	17.25W x 14.5H	53	10	36	Additional chain 2996 NI, OZ.
A	3797 CHL18, NIL18, OZSL18	(3) 10W (M) 	3000K, 92 CRI, 800 Lumens, 80 LPW	17.25W x 14.5H	53	10	36	Dimmable. Add. chain 2996 NI, OZ.
B	43512 NI, OZ	(2) 75W (M)	---	15W x 13H	---	---	---	
B	43512 NIL18, OZL18	(2) 10W (M) 	3000K, 92 CRI, 800 Lumens, 80 LPW	15W x 13H	---	---	---	Dimmable.
C	3681 NI, OZ	(2) 100W (M)	---	18.75W x 13.25H	52	8	36	Additional chain 2996 NI, OZ.
C	3681 NIL18, OZL18	(2) 10W (M) 	3000K, 92 CRI, 800 Lumens, 80 LPW	18.75W x 13.25H	52	8	36	Dimmable. Additional chain 2996 NI, OZ.
D	43169 NI, OZ	(2) 100W (M)	---	17.25W x 14.25H	---	---	---	
D	43169 NIL18, OZL18	(2) 10W (M) 	3000K, 92 CRI, 800 Lumens, 80 LPW	17.25W x 14.25H	---	---	---	Dimmable.
E	42900 NI, OZ	(2) 100W (M)	---	16W x 13H	---	---	---	
E	42900 NIL18, OZL18	(2) 10W (M) 	3000K, 92 CRI, 800 Lumens, 80 LPW	16W x 13H	---	---	---	Dimmable.

Measurements shown in inches.





ITEM #	FINISH	LIGHT SOURCE	LED BULB OUTPUT	DIMENSIONS	OVRLL. H	EXTRA WIRE	CHAIN/STEM	NOTES
F	43641 NI, OZ	(2) 100W (M)	---	15W x 13.75H	52	36	36	Additional chain 2996 NI, OZ.
F	43641 NIL18, OZL18	(2) 10W (M)	3000K, 92 CRI, 800 Lumens, 80 LPW	15W x 13.75H	52	36	36	Dimmable. Add. chain 2996 NI, OZ.
G	3694 NI, NIW, OZ, OZW	(2) 100W (M)	---	15W x 15.25H	90	30	72	Add. chain 2996 NI, OZ.
G	3694 NIWL18, OZWL18	(2) 10W (M)	3000K, 92 CRI, 800 Lumens, 80 LPW	15W x 15.25H	90	30	72	Dimmable. Add. chain 2996 NI, OZ.
H	43669 NI, OZ	(3) 100W (M)	---	15W x 13H	---	---	---	
H	43669 NIL18, OZL18	(3) 10W (M)	3000K, 92 CRI, 800 Lumens, 80 LPW	15W x 13H	---	---	---	Dimmable.
I	43925 NI, OZ	(3) 100W (M)	---	17.75W x 16.75H	91	24	72	Add. chain 2996 NI, OZ.
I	43925 NIL18, OZL18	(3) 10W (M)	3000K, 92 CRI, 800 Lumens, 80 LPW	17.75W x 16.75H	91	24	72	Dimmable. Add. chain 2996 NI, OZ.
J	43926 NI, OZ	(3) 75W (M)	---	14.25W x 11.75H	---	---	---	
J	43926 NIL18, OZL18	(3) 10W (M)	3000K, 92 CRI, 800 Lumens, 80 LPW	14.25W x 11.75H	---	---	---	Dimmable.
K	8881 NI, OZ WH	(1) 100W (M)	---	14W x 4.75H	---	---	---	
K	8881 NIL18, OZL18, WHL18	(1) 10W (M)	3000K, 92 CRI, 800 Lumens, 80 LPW	14W x 4.75H	---	---	---	Dimmable.
L	8043 NI, OZS	(1) 100W (M)	---	5W x 6.25H	---	---	---	
L	8043 NIL18, OZSL18	(1) 10W (M)	3000K, 92 CRI, 800 Lumens, 80 LPW	5W x 6.25H	---	---	---	Dimmable.

Measurements shown in inches.

# Indoor Lighting

# Ceiling

Satin Etched Glass



**A** | 3718 NI

NI, TZ: Satin Etched Glass  
NIA: Alabaster Swirl Glass



**B** | 3122 NI, NIA, TZ

Satin Etched Glass



**C** | 3348 NI

Satin Etched White Glass



**D** | 42563 BPT, OZ

NI, TZ: Etched Seeded Glass  
OZ: Umber Etched Seeded Glass



**E** | 3623 NI, OZ, TZ

NI: White Scavo Glass  
OZ: White Scavo Glass w/Light Umber Inside Tint



**F** | 43232 NI, OZ

Satin Etched Glass



**G** | 42879 NI, OZ

ITEM #	FINISH	LIGHT SOURCE	DIMENSIONS	OVRL. H	EXTRA WIRE	CHAIN/STEM	NOTES
A	3718 NI	(2) 100W (M)	13W X 10.5H	---	---	---	
B	3122 NI, NIA, TZ	(3) 100W (M)	15W x 9.75H	---	---	---	
C	3348 NI	(1) 100W (M)	12W x 15.5H	90	32	72	Additional chain 2996 NI.
D	42563 BPT, OZ	(3) 75W (M)	17.25W x 14H	---	---	---	
E	3623 NI, OZ, TZ	(3) 60W (M)	15.25W x 14H	---	---	---	
F	43232 NI, OZ	(3) 100W (M)	18W x 14.5H	---	---	---	
G	42879 NI, OZ	(3) 100W (M)	16W x 13.25H	---	---	---	

Measurements shown in inches.

= ADA Compliant 
 = DAMP 
 = WET 
 = Dark Sky Compliant 
 = LED Integrated 
 = Lamp Included 
 = CFL Lamp Included 
 = LED Bulb Included



ITEM #	FINISH	LIGHT SOURCE	DIMENSIONS	NOTES
H	43154 AP, MIZ	(2) 100W (M)	13.5W X 11.5H	Shade: AP - White translucent organza. MIZ - Light Umber Translucent Organza.
I	43194 AP, MIZ	(3) 100W (M)	18W x 11.75H	Shade: AP - White translucent organza. MIZ - Light Umber Translucent Organza.
J	43675 NI, OZ	(3) 100W (M)	14W x 10H	Shade: White micro fiber
K	43692 NI, OZ	(3) 75W (M)	18W x 11.25H	Shade: White micro fiber
L	43691 NI, OZ	(3) 75W (M)	14W x 9.75H	Shade: White micro fiber
M	43693 NI, OZ	(3) 75W (M)	18W x 11H	Shade: White micro fiber
N	3620 NI	(2) 100W (M) ❖	13.5W x 7.25H	
O	3627 NI, OZ	(3) 100W (M) ❖	15.5W x 7.75H	
P	8404 NI	(1) 100W (M)	12W x 6.25H	

Measurements shown in inches.

# Indoor Lighting

# Ceiling

NI: Etched White Glass  
TZ: Etched Sunset Glass



**A** | 8405 NI, TZ

Etched White Glass



**B** | 8406 NI

Etched White Glass



**C** | 8407 NI

Clear Seeded Glass



**D** | 42296 NI, OZ

Clear Seeded Glass



**E** | 44066 NI, OZ

Clear Seeded Glass



**F** | 44033 NI, OZ

Etched Seeded Glass



**G** | 8065 NI

Etched Seeded Glass



**H** | 8064 NI, TZ

NI, TZ: Alabaster Swirl Glass  
OZ: Light Umber Etched Glass



**I** | 8108 NI, OZ, TZ

ITEM #	FINISH	LIGHT SOURCE	DIMENSIONS	NOTES
A	NI, TZ	(2) 75W (M) ❖	15W x 6H	
B	NI	(3) 60W (M) ✓	17W x 6.5H	
C	NI	(5) 75W (M) ❖	25W x 9.5H	
D	NI, OZ	(1) 100W (M)	9.75W x 10.75H	
E	NI, OZ	(1) 75W (M)	10W x 12H	
F	NI, OZ	(1) 75W (M)	8.5W x 10.5H	
G	NI	(3) 60W (M) ❖	15.25W x 7.75H	
H	NI, TZ	(2) 60W (M) ❖	13.25W x 6.25H	
I	NI, OZ, TZ	(2) 60W (M) ❖	11.25W x 6.25H	

Measurements shown in inches.

= ADA Compliant 
 = DAMP 
 = WET 
 = Dark Sky Compliant 
 = LED Integrated 
 = Lamp Included 
 = CFL Lamp Included 
 = LED Bulb Included

NI, TZ: Alabaster Swirl Glass  
OZ: Light Umber Etched Glass



**J** | 8109 NI, OZ, TZ

NI, TZ: Alabaster Swirl Glass  
OZ: Light Umber Etched Glass



**K** | 8110 NI, OZ, TZ

Satin Etched Glass



**L** | 8653 NI, TZ

Satin Etched Glass



**M** | 8654 NI, TZ

Satin Etched Glass



**N** | 8655 NI, TZ

Satin Etched Glass



**O** | 8111 CH, NI, OZ, WH

Satin Etched Glass



**P** | 8112 CH, NI, OZ, WH

Satin Etched Glass



**Q** | 8116 CH, NI, OZ, WH

ITEM #	FINISH	LIGHT SOURCE	DIMENSIONS	NOTES
J	NI, OZ, TZ	(2) 60W (M) ❖	13.25W x 6H	
K	NI, OZ, TZ	(3) 60W (M) ✓	15.25W x 7H	
L	NI, TZ	(2) 60W (M) ❖	11.5W x 6H	
M	NI, TZ	(2) 60W (M) ❖	13.25W x 5.5H	
N	NI, TZ	(3) 60W (M) ❖	15.25W x 6.25H	
O	CH, NI, OZ, WH	(2) 60W (M) ❖	11.25W x 6.25H	
P	CH, NI, OZ, WH	(2) 60W (M) ❖	13.25W x 6H	
Q	CH, NI, OZ, WH	(3) 60W (M) ✓	15.25W x 6.5H	

Measurements shown in inches.

Satin Etched Cased Opal Twist-On Glass



**A** | 8880 NI

White Glass

Satin Etched Cased Opal Twist-On Glass



**B** | 8882 NI

White Glass

Satin Etched Glass with White Paint Inside



**C** | 7003 NI

White Glass



**D** | 206 NI, OZ, WH

White Glass



**E** | 208 WH



**F** | 209 NI, OZ, WH



**G** | 210 WH

ITEM #	FINISH	LIGHT SOURCE	DIMENSIONS	NOTES
<b>A</b>	8880 NI	(1) 75W (M) ❖	10W x 4.25H	<b>D</b>
<b>B</b>	8882 NI	(2) 75W (M) ❖	16.5W x 5.5H	<b>D</b>
<b>C</b>	7003 NI	(2) 60W (M) ❖	13W x 4.5H	
<b>D</b>	206 NI, OZ, WH	(1) 60W (M) ✓	7.5W x 5H	
<b>E</b>	208 WH	(1) 100W (M)	9W x 5H	
<b>F</b>	209 NI, OZ, WH	(2) 60W (M) ❖	9W x 5H	
<b>G</b>	210 WH	(2) 75W (M) ❖	12W x 6.75H	

Measurements shown in inches.

= ADA Compliant 
 = DAMP 
 = WET 
 = Dark Sky Compliant 
 = LED Integrated 
 = Lamp Included 
 = CFL Lamp Included 
 = LED Bulb Included

Alabaster Swirl Glass



**H** | 8206 NI

Alabaster Swirl Glass



**I** | 8209 NI

White Clip-On Glass



**J** | 8102 WH

White Glass



**K** | 216 WH

White Glass



**L** | 7260 WH

	ITEM #	FINISH	LIGHT SOURCE	DIMENSIONS	NOTES
<b>H</b>	8206	NI	(1) 60W (M) ✓	7.5W x 5H	
<b>I</b>	8209	NI	(2) 60W (M) ❖	9.25W x 5.5H	
<b>J</b>	8102	WH	(2) 60W (M) ❖	9.25W x 4.75H	
<b>K</b>	216	WH	(1) 75W (M) ✓	5.75W x 7H	
<b>L</b>	7260	WH	(2) 60W (M) ✓	12W x 5.5H	

Measurements shown in inches.

Etched Opal Glass



**A** | **83745 CH**

Etched Opal Glass



**B** | **83757 NI**

Etched Opal Glass



**C** | **83755 CH**

Etched Opal Glass



**D** | **83750 NI**

Etched Opal Glass



**E** | **83760 CH**

White Acrylic



**F** | **83792 CH**

Clear Cubic Zirconia Chip



**G** | **83728 NI**

ITEM #	FINISH	LIGHT SOURCE	LED FIXTURE OUTPUT	DIMENSIONS	EXT.	NOTES
<b>A</b> 83745	CH	21W	3000K, 91 CRI, 932 Lumens, 44 LPW	4.75W x 13H	4.25	Dimmable
<b>B</b> 83757	NI	21W	3000K, 91 CRI, 1168 Lumens, 56 LPW	4.5W x 13H	3.75	Dimmable
<b>C</b> 83755	CH	26W	3000K, 90 CRI, 1480 Lumens, 57 LPW	4.5W x 18H	3.75	Dimmable. Can be mounted vertically or horizontally.
<b>D</b> 83750	NI	21W	3000K, 91 CRI, 1100 Lumens, 52 LPW	13.25W x 4.75H	3	Dimmable
<b>E</b> 83760	CH	21W	3000K, 91 CRI, 1303 Lumens, 62 LPW	13.25W x 4.75H	3.25	Dimmable
<b>F</b> 83792	CH	18W	3000K, 92 CRI, 671 Lumens, 37 LPW	5W x 14.5H	3	Dimmable
<b>G</b> 83728	NI	12W	3200K, 84 CRI, 663 Lumens, 55 LPW	7W x 9H	2.5	Dimmable

Measurements shown in inches.

= ADA Compliant   = DAMP   = WET   = Dark Sky Compliant   = LED Integrated   = Lamp Included   = CFL Lamp Included   = LED Bulb Included



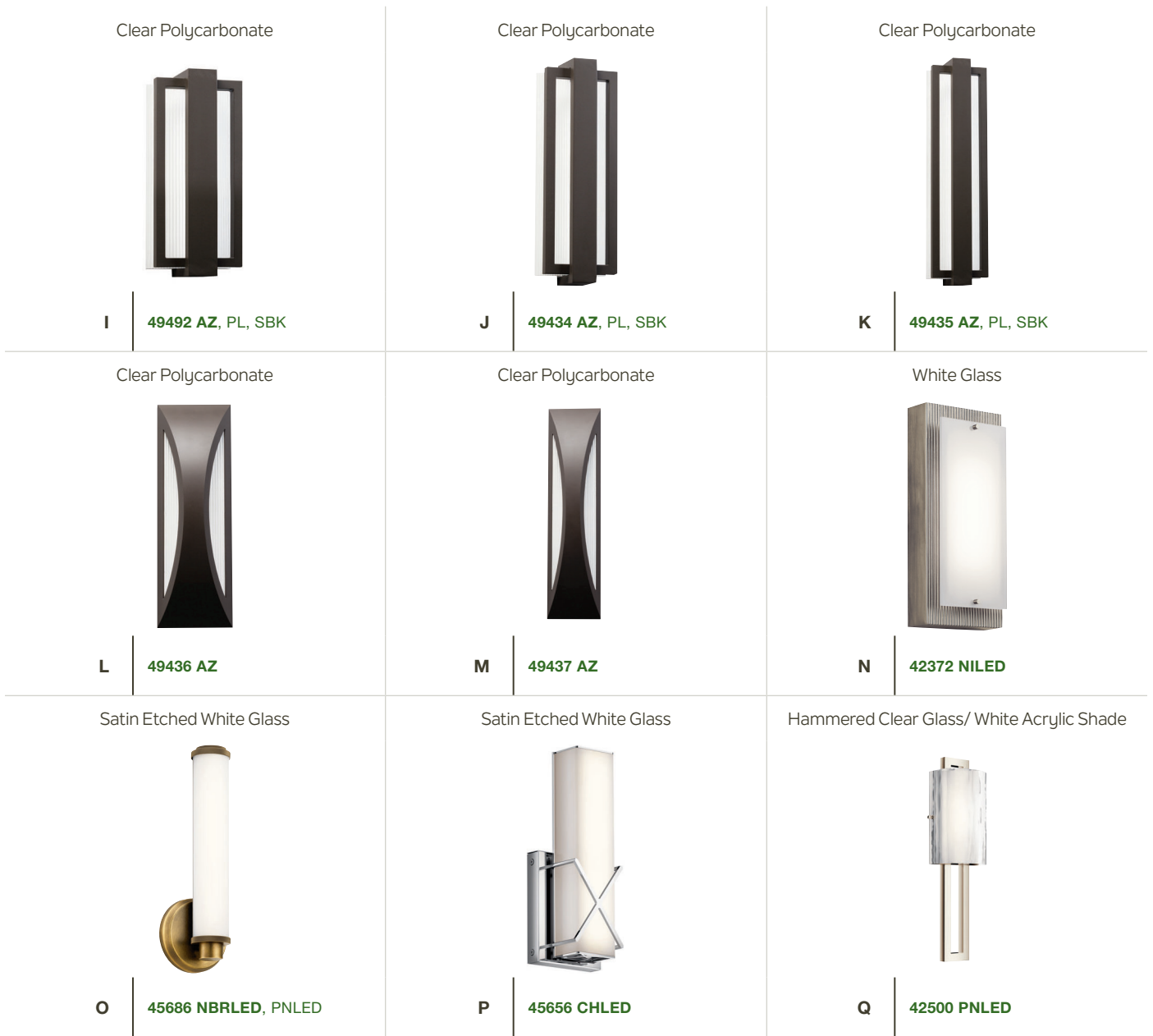

ITEM #	FINISH	LIGHT SOURCE	LED FIXTURE OUTPUT	DIMENSIONS	EXT.	HCWO	NOTES
I	49492 AZ, PL, SBK	(1) 16W	3000K, 80 CRI, 450 Lumens, 28 LPW	6W x 12.25H	4	6.25	
J	49434 AZ, PL, SBK	(1) 30W	3000K, 80 CRI, 800 Lumens, 27 LPW	6W x 18.25H	4	9.25	
K	49435 AZ, PL, SBK	(1) 30W	3000K, 80 CRI, 825 Lumens, 28 LPW	6W x 24.25H	4	12.25	
L	49436 AZ	(1) 25W	3000K, 80 CRI, 550 Lumens, 22 LPW	6W x 18H	4.75	9	
M	49437 AZ	(1) 30W	3000K, 80 CRI, 775 Lumens, 26 LPW	6W x 24H	4.75	12	
N	42372 NILED	(1) 20W	3000K, 90 CRI, 300 Lumens, 15 LPW	5W x 12H	3	6	Dimmable. May be installed vertically or horizontally.
O	45686 NBRLED, PNLED	(1) 16W	3000K, 90 CRI, 1090 Lumens, 68 LPW	5W x 14.5H	3.75	12	Dimmable. May be installed with glass up or down. May be installed vertically or horizontally.
P	45656 CHLED	(1) 30W	3000K, 90 CRI, 400 Lumens, 13 LPW	4.5W x 12H	3.5	8.75	Dimmable.
Q	42500 PNLED	(1) 20W	3000K, 90 CRI, 225 Lumens, 12 LPW	6.5W x 20H	3.75	6	May be installed with glass up or down.

For additional style and finish options, visit [elan-lighting.com](http://elan-lighting.com), or contact your local sales representative.

Measurements shown in inches.





The breadth of Kichler Lighting Products for Professional Lighting Solutions has expanded to feature more:

Universal Voltage (120V-277V) on select Sconce and Vanity fixtures

Energy Star® and Title 24 qualified fixtures to ensure quality light output and efficiency

Durable components that have been tested and re-tested to withstand 24/7 illumination

White Acrylic Diffuser



**J** | 11315 NILED, OZLED

White Acrylic Diffuser



**K** | 11319 NILED, OZLED

White Acrylic Diffuser with Natural Linen



**L** | 10421 SNLED

White Acrylic Diffuser with White Linen



**M** | 10438 NCHLED

White Acrylic Diffuser with White Linen



**N** | 10439 NCHLED

White Acrylic Diffuser



**O** | 10620 NILED

	ITEM #	FINISH	LIGHT SOURCE	LED FIXTURE OUTPUT	DIMENSIONS	EXT.	HCWO	NOTES
<b>J</b>	11315	NILED, OZLED	(1) 22W	3000K, 90 CRI, 1375 Lumens, 63 LPW	7W x 16H	3.75	8	Dimmable. 120-277V
<b>K</b>	11319	NILED, OZLED	(1) 15W	3000K, 90 CRI, 925 Lumens, 62 LPW	9.5W x 10.75H	3.75	5.25	Dimmable. 120-277V
<b>L</b>	10421	SNLED	(1) 16W	3000K, 90 CRI, 910 Lumens, 57 LPW	12W x 10H	4	5	Dimmable. Linen shade.
<b>M</b>	10438	NCHLED	(1) 8W	3000K, 90 CRI, 420 Lumens, 53 LPW	5.5W x 14.25H	3.75	5.25	Dimmable. Linen shade.
<b>N</b>	10439	NCHLED	(1) 16W	3000K, 90 CRI, 880 Lumens, 55 LPW	11W x 14.25H	3.75	5.25	Dimmable. Linen shade.
<b>O</b>	10620	NILED	(1) 16W	3000K, 90 CRI, 790 Lumens, 50 LPW	13W x 9.5H	4	5	Dimmable.

Measurements shown in inches.



White Acrylic Diffuser



**A** | 10630 PNLED

White Acrylic Diffuser



**B** | 10795 NILED

White Acrylic Diffuser



**C** | 10797 NILED

White Acrylic Diffuser



**D** | 10790 NILED, OZLED



Throughout this catalog, look for these icons, as well as “L18” in the model number to identify fixtures that come with LED, Energy Star® Rated light bulbs

ITEM #	FINISH	LIGHT SOURCE	LED FIXTURE OUTPUT	DIMENSIONS	EXT.	HCWO	NOTES
<b>A</b>	10630 PNLED	(1) 16W	3000K, 90 CRI, 770 Lumens, 48 LPW	15W x 5.5H	4	2.75	Dimmable.
<b>B</b>	10795 NILED	(1) 16W	3000K, 90 CRI, 910 Lumens, 57 LPW	11W x 11.75H	4	6	Dimmable.
<b>C</b>	10797 NILED	(1) 16W	3000K, 90 CRI, 870 Lumens, 54 LPW	8.25W x 8H	3.5	4.75	Dimmable.
<b>D</b>	10790 NILED, OZLED	(1) 15W	3000K, 90 CRI, 900 Lumens, 60 LPW	11.75W x 6H	3.5	2.5	Dimmable.

Measurements shown in inches.



# LED Options

Satin Etched Cased Opal Glass



**E** | 5096 NI, OZS  
5096 NIL18, OZSL18

Satin Etched Cased Opal Glass



**F** | 45921 NI, OZ  
45921 NIL18, OZL18

Satin Etched White Glass



**G** | 5388 NI, OZ  
5388 NIL18, OZL18

Satin Etched Cased Opal Glass



**H** | 45568 NI, OZ  
45568 NIL18, OZL18

Satin Etched White Glass



**I** | 45504 NI, OZ  
45504 NIL18, OZL18

Satin Etched Glass



**J** | 45637 CH, NI, OZ  
45637 CHL18, NIL18, OZL18

NI: Satin Etched Glass  
OZ: Light Umber Etched Glass



**K** | 43170 NI, OZ  
43170 NIL18, OZL18

Satin Etched Glass



**L** | 45938 NI, OZ  
45938 NIL18, OZL18

Satin Etched Glass



**M** | 45901 NI, OZ  
45901 NIL18, OZL18

ITEM #	FINISH	LIGHT SOURCE	LED BULB OUTPUT	DIMENSIONS	EXT.	HCWO	NOTES
E	NI, OZS	(1) 100W (M)	---	4.5W x 10.75H	7	5.75	Ⓧ May be installed with glass up or down.
E	NIL18, OZSL18	(1) 10W (M)	3000K, 92 CRI, 800 Lumens, 80 LPW	4.5W x 10.75H	7	5.75	Ⓧ Dimmable. May be installed with glass up or down.
F	NI, OZ	(1) 100W (M)	---	5W x 18.25H	5.25	9	Ⓧ May be installed with glass up or down.
F	NIL18, OZL18	(1) 10W (M)	3000K, 92 CRI, 800 Lumens, 80 LPW	5W x 18.25H	5.25	9	Ⓧ Dimmable. May be installed with glass up or down.
G	NI, OZ	(1) 100W (M)	---	7.25W x 7.75H	8.25	4.5	Ⓧ May be installed with glass up or down.
G	NIL18, OZL18	(1) 10W (M)	3000K, 92 CRI, 800 Lumens, 80 LPW	7.25W x 7.75H	8.25	4.5	Ⓧ Dimmable. May be installed with glass up or down.
H	NI, OZ	(1) 100W (M)	---	5.5W x 10.75H	7.25	5.5	Ⓧ May be installed with glass up or down.
H	NIL18, OZL18	(1) 10W (M)	3000K, 92 CRI, 800 Lumens, 80 LPW	5.5W x 10.75H	7.25	5.5	Ⓧ Dimmable. May be installed with glass up or down.
I	NI, OZ	(1) 100W (M)	---	5.75W x 8.5H	9.25	3.25	Ⓧ May be installed with glass up or down.
I	NIL18, OZL18	(1) 10W (M)	3000K, 92 CRI, 800 Lumens, 80 LPW	5.75W x 8.5H	9.25	3.25	Ⓧ Dimmable. May be installed with glass up or down.
J	CH, NI, OZ	(1) 100W (M)	---	5W x 9H	6.25	4.25	Ⓧ May be installed with glass up or down.
J	CHL18, NIL18, OZL18	(1) 10W (M)	3000K, 92 CRI, 800 Lumens, 80 LPW	5W x 9H	6.25	4.25	Ⓧ Dimmable. May be installed with glass up or down.
K	NI, OZ	(1) 100W (M)	---	6W x 14H	9.25	8	Ⓧ May be installed with glass up or down.
K	NIL18, OZL18	(1) 10W (M)	3000K, 92 CRI, 800 Lumens, 80 LPW	6W x 14H	9.25	8	Ⓧ Dimmable. May be installed with glass up or down.
L	NI, OZ	(1) 100W (M)	---	6.5W x 10.75H	8.75	5	Ⓧ May be installed with glass up or down.
L	NIL18, OZL18	(1) 10W (M)	3000K, 92 CRI, 800 Lumens, 80 LPW	6.5W x 10.75H	8.75	5	Ⓧ Dimmable. May be installed with glass up or down.
M	NI, OZ	(1) 100W (M)	---	6W x 9.25H	8.5	5.25	Ⓧ May be installed with glass up or down.
M	NIL18, OZL18	(1) 10W (M)	3000K, 92 CRI, 800 Lumens, 80 LPW	6W x 9.25H	8.5	5.25	Ⓧ Dimmable. May be installed with glass up or down.

Measurements shown in inches.

Incandescent fixtures offer breadth of style and versatility

Often, unique bulb types (like an Edison bulb) are used as a design element to further enhance the look of the fixture

Satin Etched Cased Opal Glass



**A** 45495 CH, NI, OZ

Satin Etched Cased Opal Glass



**B** 45888 NI, OZ

Satin Etched Cased Opal Glass



**C** 45358 BPT, CH, OZ

Satin Etched Glass



**D** 45572 CH, NI, OZ

Clear Seeded Glass



**E** 45910 NI, OZ

Clear Glass



**F** 45892 NI, OZ

Clear Seeded Glass



**G** 45590 AP, OZ

Satin Etched Cased Opal Glass



**H** 6520 NI, OZ

ITEM #	FINISH	LIGHT SOURCE	DIMENSIONS	EXT.	HCWO	NOTES
A	45495 CH, NI, OZ	(1) 100W (M)	4.5W x 9.25H	6.25	5.75	Ⓧ May be installed with glass up or down.
B	45888 NI, OZ	(1) 75W (M)	5W x 12.5H	6.5	6.5	Ⓧ May be installed with glass up or down.
C	45358 BPT, CH, OZ	(1) 100W (M)	5.75W x 14H	7.5	7	Ⓧ May be installed with glass up or down.
D	45572 CH, NI, OZ	(1) 100W (M)	5W x 8.25H	6	4.75	Ⓧ May be installed with glass up or down.
E	45910 NI, OZ	(1) 75W (M)	4.75W x 9.25H	6.5	7	Ⓧ May be installed with glass up or down.
F	45892 NI, OZ	(1) 75W (M)	6.5W x 8H	8.25	5.5	Ⓧ May be installed with glass up or down.
G	45590 AP, OZ	(1) 100W (M)	5.5W x 10H	7.25	2.5	Ⓧ May be installed with glass up or down.
H	6520 NI, OZ	(1) 75W (M)	6W x 8H	4	4	Ⓧ

Measurements shown in inches.

= ADA Compliant 
 = DAMP 
 = WET 
 = Dark Sky Compliant 
 = LED Integrated 
 = Lamp Included 
 = CFL Lamp Included 
 = LED Bulb Included

Satin Etched Cased Opal Glass



**I** | 45595 AP, OZ

Etched Seeded Glass



**J** | 6719 NI, TZ

Satin Etched Glass



**K** | 45881 NI, OZ

CH, NI: Alabaster Swirl Glass  
OZ: Umber Etched Glass



**L** | 5991 CH, NI, OZ

NI: White Scavo Glass  
OZ: White Scavo with Light Umber Inside Tint



**M** | 45421 NI, OZ

Satin Etched Glass



**N** | 5294 NI, OZ

Cased Opal Glass



**O** | 6121 CH, NI

AP, MIZ: Satin Etched White Inner Diffusers\*



**P** | 45449 AP, MIZ

ITEM #	FINISH	LIGHT SOURCE	DIMENSIONS	EXT.	HCWO	NOTES
<b>I</b>	45595 AP, OZ	(1) 100W (M)	5W x 9.5H	7.75	6	Ⓧ May be installed with glass up or down.
<b>J</b>	6719 NI, TZ	(1) 100W (M)	6.25W x 6.5H	6.75	4.25	Ⓧ May be installed with glass up or down.
<b>K</b>	45881 NI, OZ	(1) 100W (M)	6W x 10H	8.5	5	Ⓧ May be installed with glass up or down.
<b>L</b>	5991 CH, NI, OZ	(1) 100W (M)	7.25W x 12H	9	6	Ⓧ May be installed with glass up or down.
<b>M</b>	45421 NI, OZ	(1) 100W (M)	6W x 12.5H	8.75	8.5	Ⓧ May be installed with glass up or down.
<b>N</b>	5294 NI, OZ	(1) 100W (M)	6W x 7.5H	8.5	3.5	Ⓧ May be installed with glass up or down.
<b>O</b>	6121 CH, NI	(1) 100W (M)	5W x 8.75H	7.75	5.75	Ⓧ May be installed with glass up or down.
<b>P</b>	45449 AP, MIZ	(1) 60W (C)	5W x 7.5H	6.5	3.75	Ⓧ * Shades: AP: White Translucent Organza Outer, MIZ: Light Umber Translucent Organza Outer.

Measurements shown in inches.

Etched Opal Glass



**A** | **83743 NI**

Etched Opal Glass

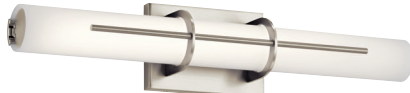

**B** | **83756 NI**

Etched Opal Glass



**C** | **83752 NI**

Etched Opal Glass



**D** | **83749 BZ**

Etched Opal Glass







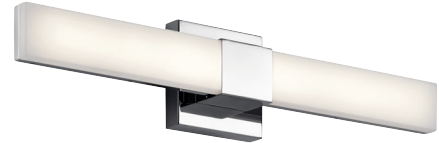













**E** | **83759 NI**

Etched Opal Glass



**F** | **83736 NI**

ITEM #	FINISH	LIGHT SOURCE	LED FIXTURE OUTPUT	DIMENSIONS	EXT.	HCWO	NOTES
<b>A</b> 83743	NI	(1) 42W  	3000K, 91 CRI, 2246 Lumens, 53 LPW	25.25W x 4.75H	4.25	---	 Dimmable.
<b>B</b> 83756	NI	(1) 37W  	3000K, 91 CRI, 2054 Lumens, 56 LPW	22W x 4.5H	3.75	---	 Dimmable.
<b>C</b> 83752	NI	(1) 37W  	3000K, 91 CRI, 2053 Lumens, 55 LPW	24W x 4.5H	3.75	---	 Dimmable.
<b>D</b> 83749	BZ	(1) 42W  	3000K, 91 CRI, 2534 Lumens, 60 LPW	25.25W x 4.75H	3	---	 Dimmable.
<b>E</b> 83759	NI	(1) 42W  	3000K, 91 CRI, 2586 Lumens, 61 LPW	25.25W x 4.75H	3.25	---	 Dimmable.
<b>F</b> 83736	NI	(1) 24W  	3000K, 95 CRI, 1395 Lumens, 58 LPW	24W x 5H	3	---	 Dimmable.

Measurements shown in inches.

For additional style and finish options, visit [elan-lighting.com](http://elan-lighting.com), or contact your local sales representative.



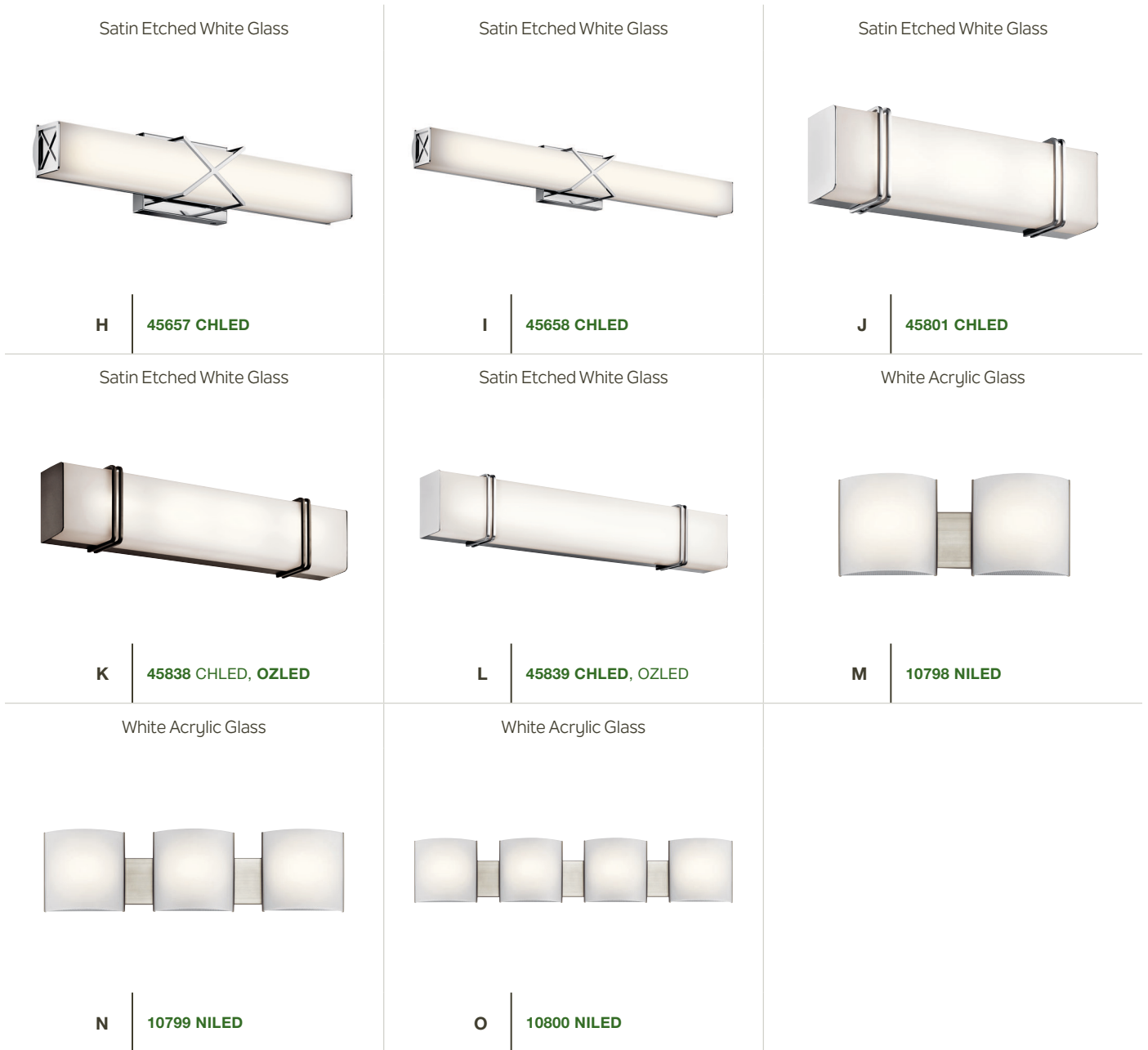

ITEM #	FINISH	LIGHT SOURCE	LED FIXTURE OUTPUT	DIMENSIONS	EXT.	HCWO	NOTES
H	45657 CHLED	(2) 23W	3000K, 90 CRI, 1551 Lumens, 66 LPW	22W x 4.5H	3.5	2.25	Dimmable. May be installed vertically or horizontally.
I	45658 CHLED	(3) 38.5W	3000K, 90 CRI, 2499 Lumens, 64 LPW	32W x 4.5H	3.5	2.25	Dimmable. May be installed vertically or horizontally.
J	45801 CHLED	(1) 20W	3000K, 90 CRI, 900 Lumens, 45 LPW	18.25W x 5.5H	3.5	2.75	Dimmable. May be installed vertically or horizontally.
K	45838 CHLED, OZLED	(1) 25W	3000K, 90 CRI, 1200 Lumens, 46 LPW	24.25W x 5.5H	3.5	2.75	Dimmable. May be installed vertically or horizontally.
L	45839 CHLED, OZLED	(1) 30W	3000K, 90 CRI, 1275 Lumens, 43 LPW	30.25W x 5.5H	3.5	2.75	Dimmable. May be installed vertically or horizontally.
M	10798 NILED	(2) 32W	3000K, 90 CRI, 1740 Lumens, 54 LPW	19.25W x 6H	3.5	3	Dimmable.
N	10799 NILED	(3) 48W	3000K, 90 CRI, 2640 Lumens, 54 LPW	30W x 6H	3.5	3	Dimmable.
O	10800 NILED	(4) 64W	3000K, 90 CRI, 3540 Lumens, 55 LPW	40.75W x 6H	3.5	3	Dimmable.

Measurements shown in inches.

Satin Etched White Glass



**A** | 45685 NBRLED, PNLED

Satin Etched White Glass



**B** | 45682 CHLED

Satin Etched White Glass



**C** | 45683 CHLED

Satin Etched White Glass



**D** | 45679 CHLED, NILED

Satin Etched White Glass



**E** | 45680 CHLED, NILED

White Polycarbonate



**F** | 11141 NILED

White Polycarbonate



**G** | 11142 NILED

White Polycarbonate



**H** | 11143 NILED

White Polycarbonate



**I** | 11144 NILED

ITEM #	FINISH	LIGHT SOURCE	LED FIXTURE OUTPUT	DIMENSIONS	EXT.	HCWO	NOTES
A	45685 NBRLED, PNLED	(2) 31W	3000K, 90 CRI, 1915 Lumens, 61 LPW	27W x 5H	3.75	2.5	Dimmable. May be installed vertically or horizontally.
B	45682 CHLED	(2) 31W	3000K, 90 CRI, 1650 Lumens, 53 LPW	24.75W x 5H	3.25	2.5	Dimmable. May be installed vertically or horizontally.
C	45683 CHLED	(4) 46W	3000K, 90 CRI, 2470 Lumens, 53 LPW	36.5W x 5H	3.25	2.5	Dimmable. May be installed vertically or horizontally.
D	45679 CHLED, NILED	(2) 31W	3000K, 90 CRI, 1650 Lumens, 53 LPW	26.5W x 5H	3.5	2.5	Dimmable. May be installed vertically or horizontally.
E	45680 CHLED, NILED	(4) 46W	3000K, 90 CRI, 2470 Lumens, 53 LPW	38.5W x 5H	3.5	2.5	Dimmable. May be installed vertically or horizontally.
F	11141 NILED	(1) 10W	3000K, 90 CRI, 640 Lumens, 64 LPW	12.75W x 4.5H	4	2.25	Dimmable. May be installed vertically or horizontally.
G	11142 NILED	(1) 20W	3000K, 90 CRI, 1410 Lumens, 71 LPW	24.75W x 4.5H	4	2.25	Dimmable. May be installed vertically or horizontally.
H	11143 NILED	(1) 25.5W	3000K, 90 CRI, 1960 Lumens, 77 LPW	36.5W x 4.5H	4	2.25	Dimmable. May be installed vertically or horizontally.
I	11144 NILED	(1) 38W	3000K, 90 CRI, 3030 Lumens, 80 LPW	48.75W x 4.5H	4	2.25	Dimmable. May be installed vertically or horizontally.

Measurements shown in inches.

= ADA Compliant = DAMP = WET = Dark Sky Compliant = LED Integrated = Lamp Included = CFL Lamp Included = LED Bulb Included

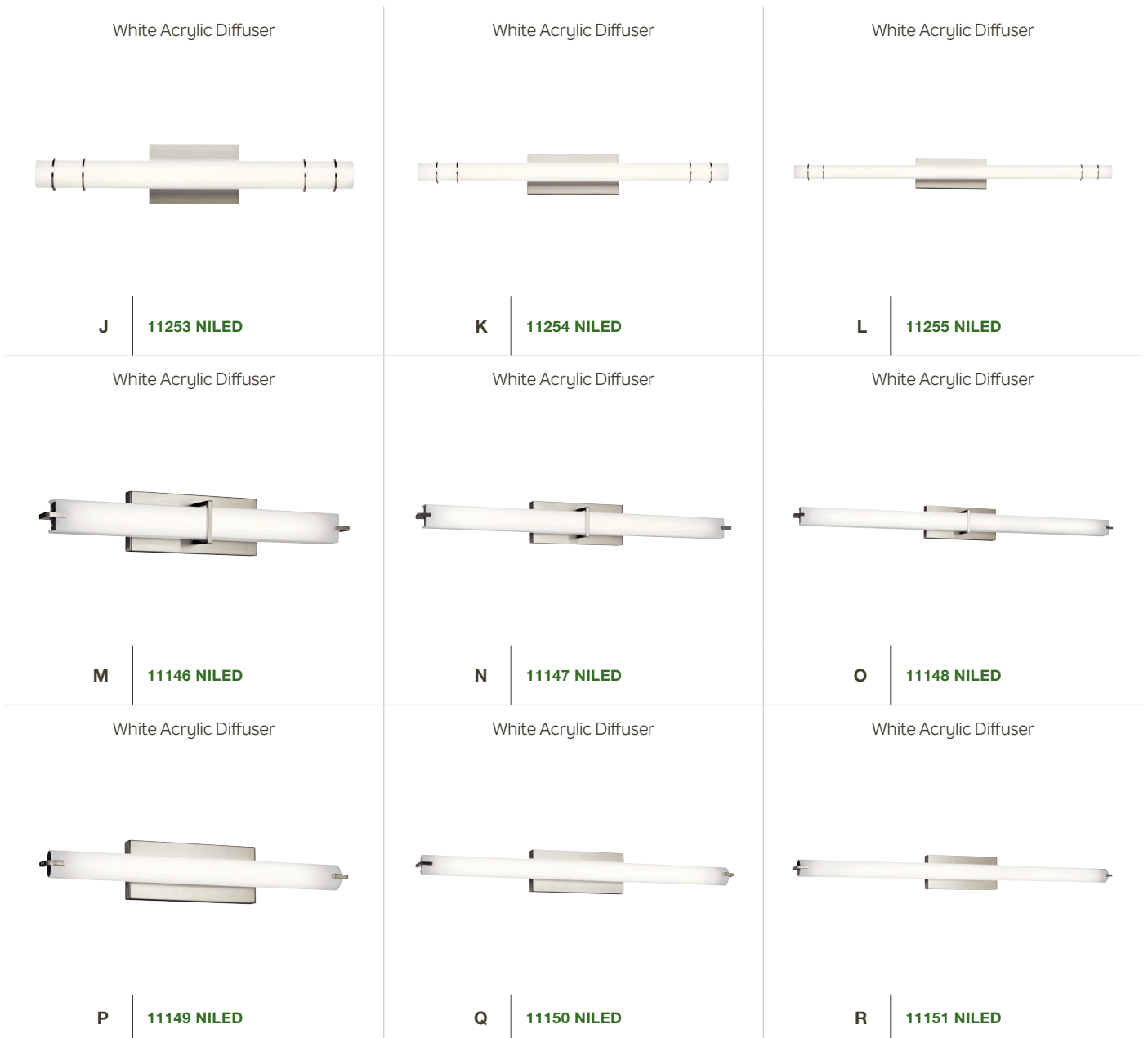

ITEM #	FINISH	LIGHT SOURCE	LED FIXTURE OUTPUT	DIMENSIONS	EXT.	HCWO	NOTES
J	11253	NILED (1) 22W	3000K, 90 CRI, 1425 Lumens, 70 LPW	24.75W x 4.75H	3.75	2.5	Dimmable. May be installed vertically or horizontally. 120V-277V.
K	11254	NILED (1) 25W	3000K, 90 CRI, 1725 Lumens, 69 LPW	36.75W x 4.75H	3.75	2.5	Dimmable. May be installed vertically or horizontally. 120V-277V.
L	11255	NILED (1) 38W	3000K, 90 CRI, 2525 Lumens, 72 LPW	48.5W x 4.75H	3.75	2.5	Dimmable. May be installed vertically or horizontally. 120V-277V.
M	11146	NILED (1) 19W	3000K, 90 CRI, 1420 Lumens, 75 LPW	25.75W x 4.75H	4.25	2.25	Dimmable. May be installed vertically or horizontally. 120V-277V.
N	11147	NILED (1) 23W	3000K, 90 CRI, 1850 Lumens, 75 LPW	37.5W x 4.75H	4.25	2.25	Dimmable. May be installed vertically or horizontally. 120V-277V.
O	11148	NILED (1) 38W	3000K, 90 CRI, 2680 Lumens, 71 LPW	49.25W x 4.75H	4.25	4.25	Dimmable. May be installed vertically or horizontally. 120V-277V.
P	11149	NILED (1) 19W	3000K, 90 CRI, 1440 Lumens, 76 LPW	25.5W x 4.75H	4	2.25	Dimmable. May be installed vertically or horizontally. 120V-277V.
Q	11150	NILED (1) 23W	3000K, 90 CRI, 1890 Lumens, 82 LPW	37.25W x 4.75H	4	2.25	Dimmable. May be installed vertically or horizontally. 120V-277V.
R	11151	NILED (1) 38W	3000K, 90 CRI, 2750 Lumens, 72 LPW	49W x 4.75H	4	2.25	Dimmable. May be installed vertically or horizontally. 120V-277V.

Measurements shown in inches.

Throughout this catalog, look for these icons, as well as “L18” in the model number to identify fixtures that come with LED, Energy Star® Rated light bulbs



Satin Etched Cased Opal Glass



**A** | 5097 CH, NI, OZS  
5097 CHL18, NIL18, OZSL18

Satin Etched Cased Opal Glass



**B** | 5098 CH, NI, OZS  
5098 CHL18, NIL18, OZSL18

Satin Etched Cased Opal Glass



**C** | 5099 CH, NI, OZS  
5099 CHL18, NIL18, OZSL18

Satin Etched White Glass



**D** | 5389 NI, OZ  
5389 NIL18, OZL18

Satin Etched White Glass



**E** | 5390 NI, OZ  
5390 NIL18, OZL18

Satin Etched White Glass



**F** | 5391 NI, OZ  
5391 NIL18, OZL18

ITEM #	FINISH	LIGHT SOURCE	LED BULB OUTPUT	DIMENSIONS	EXT.	HCWO	NOTES
A 5097	CH, NI, OZS	(2) 100W (M)	---	14.25W x 9.25H	6	2.25	Ⓧ May be installed with glass up or down.
A 5097	CHL18, NIL18, OZSL18	(2) 10W (M)	3000K, 92 CRI, 800 Lumens, 80 LPW	14.25W x 9.25H	6	2.25	Ⓧ Dimmable. May be installed with glass up or down.
B 5098	CH, NI, OZS	(3) 100W (M)	---	24W x 9.25H	6	6.75	Ⓧ May be installed with glass up or down.
B 5098	CHL18, NIL18, OZSL18	(3) 10W (M)	3000K, 92 CRI, 800 Lumens, 80 LPW	24W x 9.25H	6	6.75	Ⓧ Dimmable. May be installed with glass up or down.
C 5099	CH, NI, OZS	(4) 100W (M)	---	33.75W x 9.25H	6	6.75	Ⓧ May be installed with glass up or down.
C 5099	CHL18, NIL18, OZSL18	(4) 10W (M)	3000K, 92 CRI, 800 Lumens, 80 LPW	33.75W x 9.25H	6	6.75	Ⓧ Dimmable. May be installed with glass up or down.
D 5389	NI, OZ	(2) 100W (M)	---	17.5W x 8.5H	8.25	2.25	Ⓧ May be installed with glass up or down.
D 5389	NIL18, OZL18	(2) 10W (M)	3000K, 92 CRI, 800 Lumens, 80 LPW	17.5W x 8.5H	8.25	2.25	Ⓧ Dimmable. May be installed with glass up or down.
E 5390	NI, OZ	(3) 100W (M)	---	26.25W x 8.5H	8.25	6.25	Ⓧ May be installed with glass up or down.
E 5390	NIL18, OZL18	(3) 10W (M)	3000K, 92 CRI, 800 Lumens, 80 LPW	26.25W x 8.5H	8.25	6.25	Ⓧ Dimmable. May be installed with glass up or down.
F 5391	NI, OZ	(4) 100W (M)	---	35W x 8.5H	8.25	6.25	Ⓧ May be installed with glass up or down.
F 5391	NIL18, OZL18	(4) 10W (M)	3000K, 92 CRI, 800 Lumens, 80 LPW	35W x 8.5H	8.25	6.25	Ⓧ Dimmable. May be installed with glass up or down.

Measurements shown in inches.



Satin Etched Cased Opal Glass



**G** | 45569 NI, OZ  
45569 NIL18, OZL18

Satin Etched Cased Opal Glass



**H** | 45570 NI, OZ  
45570 NIL18, OZL18

Satin Etched Cased Opal Glass



**I** | 45571 NI, OZ  
45571 NIL18, OZL18

Satin Etched White Glass



**J** | 45512 NI, OZ  
45512 NIL18, OZL18

Satin Etched White Glass



**K** | 45513 NI, OZ  
45513 NIL18, OZL18

Satin Etched White Glass



**L** | 45514 NI, OZ  
45514 NIL18, OZL18

Satin Etched White Glass



**M** | 45375 CH, NI, OZ  
45375 CHL18, NIL18, OZL18

Satin Etched White Glass



**N** | 45376 CH, NI, OZ  
45376 CHL18, NIL18, OZL18

Satin Etched White Glass



**O** | 45377 CH, NI, OZ  
45377 CHL18, NIL18, OZL18

ITEM #	FINISH	LIGHT SOURCE	LED BULB OUTPUT	DIMENSIONS	EXT.	HCWO	NOTES
<b>G</b> 45569	NI, OZ	(2) 100W (M)	---	13W x 10.75H	6.5	3.5	Ⓧ May be installed with glass up or down.
<b>G</b> 45569	NIL18, OZL18	(2) 10W (M)	3000K, 92 CRI, 800 Lumens, 80 LPW	13W x 10.75H	6.5	3.5	Ⓧ Dimmable. May be installed with glass up or down.
<b>H</b> 45570	NI, OZ	(3) 100W (M)	---	21W x 11H	7.25	7.5	Ⓧ May be installed with glass up or down.
<b>H</b> 45570	NIL18, OZL18	(3) 10W (M)	3000K, 92 CRI, 800 Lumens, 80 LPW	21W x 11H	7.25	7.5	Ⓧ Dimmable. May be installed with glass up or down.
<b>I</b> 45571	NI, OZ	(4) 100W (M)	---	29W x 10.75H	6.5	7.5	Ⓧ May be installed with glass up or down.
<b>I</b> 45571	NIL18, OZL18	(4) 10W (M)	3000K, 92 CRI, 800 Lumens, 80 LPW	29W x 10.75H	6.5	7.5	Ⓧ Dimmable. May be installed with glass up or down.
<b>J</b> 45512	NI, OZ	(2) 100W (M)	---	14W x 8.25H	8.5	4.75	Ⓧ May be installed with glass up or down.
<b>J</b> 45512	NIL18, OZL18	(2) 10W (M)	3000K, 92 CRI, 800 Lumens, 80 LPW	14W x 8.25H	8.5	4.75	Ⓧ Dimmable. May be installed with glass up or down.
<b>K</b> 45513	NI, OZ	(3) 100W (M)	---	22W x 8.25H	8.5	3.5	Ⓧ May be installed with glass up or down.
<b>K</b> 45513	NIL18, OZL18	(3) 10W (M)	3000K, 92 CRI, 800 Lumens, 80 LPW	22W x 8.25H	8.5	3.5	Ⓧ Dimmable. May be installed with glass up or down.
<b>L</b> 45514	NI, OZ	(4) 100W (M)	---	30W x 8.25H	8.5	4.75	Ⓧ May be installed with glass up or down.
<b>L</b> 45514	NIL18, OZL18	(4) 10W (M)	3000K, 92 CRI, 800 Lumens, 80 LPW	30W x 8.25H	8.5	4.75	Ⓧ Dimmable. May be installed with glass up or down.
<b>M</b> 45375	CH, NI, OZ	(2) 100W (M)	---	14W x 8.75H	5.75	6.5	Ⓧ May be installed with glass up or down.
<b>M</b> 45375	CHL18, NIL18, OZL18	(2) 10W (M)	3000K, 92 CRI, 800 Lumens, 80 LPW	14W x 8.75H	5.75	6.5	Ⓧ Dimmable. May be installed with glass up or down.
<b>N</b> 45376	CH, NI, OZ	(3) 100W (M)	---	23W x 8.5H	5.75	6	Ⓧ May be installed with glass up or down.
<b>N</b> 45376	CHL18, NIL18, OZL18	(3) 10W (M)	3000K, 92 CRI, 800 Lumens, 80 LPW	23W x 8.5H	5.75	6	Ⓧ Dimmable. May be installed with glass up or down.
<b>O</b> 45377	CH, NI, OZ	(4) 100W (M)	---	32.25W x 9H	5.75	2.5	Ⓧ May be installed with glass up or down.
<b>O</b> 45377	CHL18, NIL18, OZL18	(4) 10W (M)	3000K, 92 CRI, 800 Lumens, 80 LPW	32.25W x 9H	5.75	2.5	Ⓧ Dimmable. May be installed with glass up or down.

Measurements shown in inches.

# Indoor Lighting

# Vanity – LED Options

Satin Etched Cased Opal Glass

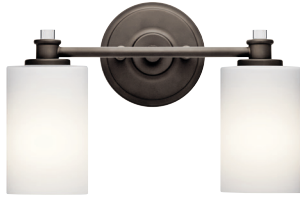

**A** 45922 NI, OZ  
45922 NIL18, OZL18

Satin Etched Cased Opal Glass



**B** 45923 NI, OZ  
45923 NIL18, OZL18

Satin Etched Cased Opal Glass



**C** 45924 NI, OZ  
45924 NIL18, OZL18

Satin Etched Glass



**D** 45638 CH, NI, OZ  
45638 CHL18, NIL18, OZL18

Satin Etched Glass



**E** 45639 CH, NI, OZ  
45639 CHL18, NIL18, OZL18

Satin Etched Glass



**F** 45640 CH, NI, OZ  
45640 CHL18, NIL18, OZL18

NI: Satin Etched Glass  
OZ: Light Umber Etched Glass



**G** 45054 NI, OZ  
45054 NIL18, OZL18

NI: Satin Etched Glass  
OZ: Light Umber Etched Glass



**H** 45055 NI, OZ  
45055 NIL18, OZL18

NI: Satin Etched Glass  
OZ: Light Umber Etched Glass











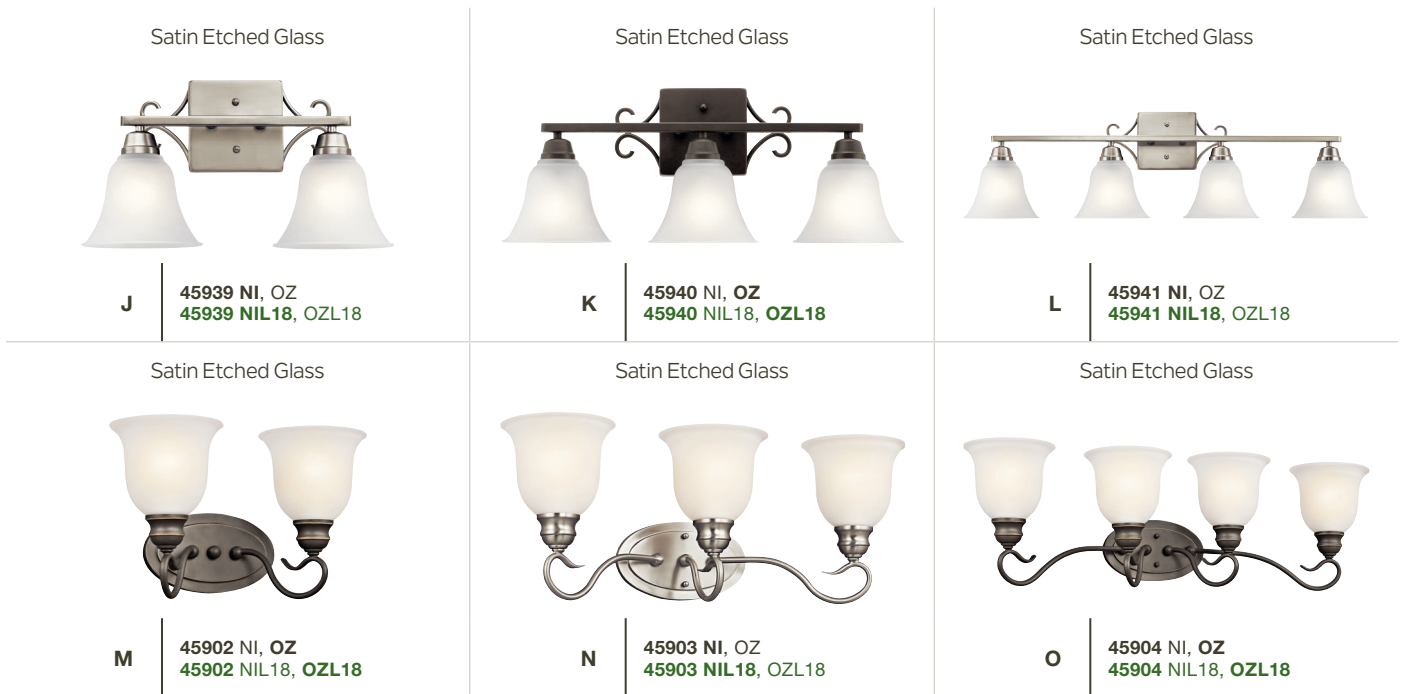



**I** 45056 NI, OZ  
45056 NIL18, OZL18

ITEM #	FINISH	LIGHT SOURCE	LED BULB OUTPUT	DIMENSIONS	EXT.	HCWO	NOTES
A	45922 NI, OZ	(2) 100W (M)	---	14W x 9.25H	5.25	6.75	ⓓ May be installed with glass up or down.
A	45922 NIL18, OZL18	(2) 10W (M)	3000K, 92 CRI, 800 Lumens, 80 LPW	14W x 9.25H	5.25	6.75	ⓓ Dimmable. May be installed with glass up or down.
B	45923 NI, OZ	(3) 100W (M)	---	24W x 9.25H	5.25	6.75	ⓓ May be installed with glass up or down.
B	45923 NIL18, OZL18	(3) 10W (M)	3000K, 92 CRI, 800 Lumens, 80 LPW	24W x 9.25H	5.25	6.75	ⓓ Dimmable. May be installed with glass up or down.
C	45924 NI, OZ	(4) 100W (M)	---	34W x 9.25H	5.25	6.75	ⓓ May be installed with glass up or down.
C	45924 NIL18, OZL18	(4) 10W (M)	3000K, 92 CRI, 800 Lumens, 80 LPW	34W x 9.25H	5.25	6.75	ⓓ Dimmable. May be installed with glass up or down.
D	45638 CH, NI, OZ	(2) 100W (M)	---	13W x 9.25H	8	4.75	ⓓ May be installed with glass up or down.
D	45638 CHL18, NIL18, OZL18	(2) 10W (M)	3000K, 92 CRI, 800 Lumens, 80 LPW	13W x 9.25H	8	4.75	ⓓ Dimmable. May be installed with glass up or down.
E	45639 CH, NI, OZ	(3) 100W (M)	---	20.25W x 9.25H	8	4.75	ⓓ May be installed with glass up or down.
E	45639 CHL18, NIL18, OZL18	(3) 10W (M)	3000K, 92 CRI, 800 Lumens, 80 LPW	20.25W x 9.25H	8	4.75	ⓓ Dimmable. May be installed with glass up or down.
F	45640 CH, NI, OZ	(4) 100W (M)	---	28W x 9.25H	8	4.75	ⓓ May be installed with glass up or down.
F	45640 CHL18, NIL18, OZL18	(4) 10W (M)	3000K, 92 CRI, 800 Lumens, 80 LPW	28W x 9.25H	8	4.75	ⓓ Dimmable. May be installed with glass up or down.
G	45054 NI, OZ	(2) 100W (M)	---	18W x 11.5H	8	6.5	ⓓ May be installed with glass up or down.
G	45054 NIL18, OZL18	(2) 10W (M)	3000K, 92 CRI, 800 Lumens, 80 LPW	18W x 11.5H	8	6.5	ⓓ Dimmable. May be installed with glass up or down.
H	45055 NI, OZ	(3) 100W (M)	---	24W x 11.5H	8	6.5	ⓓ May be installed with glass up or down.
H	45055 NIL18, OZL18	(3) 10W (M)	3000K, 92 CRI, 800 Lumens, 80 LPW	24W x 11.5H	8	6.5	ⓓ Dimmable. May be installed with glass up or down.
I	45056 NI, OZ	(4) 100W (M)	---	36W x 11.5H	8	6.5	ⓓ May be installed with glass up or down.
I	45056 NIL18, OZL18	(4) 10W (M)	3000K, 92 CRI, 800 Lumens, 80 LPW	36W x 11.5H	8	6.5	ⓓ Dimmable. May be installed with glass up or down.

Measurements shown in inches.

= ADA Compliant = DAMP = WET = Dark Sky Compliant = LED Integrated = Lamp Included = CFL Lamp Included = LED Bulb Included



	ITEM #	FINISH	LIGHT SOURCE	LED BULB OUTPUT	DIMENSIONS	EXT.	HCWO	NOTES
<b>J</b>	45939	NI, OZ	(2) 100W (M)	---	16.75W x 9.5H	7	6.75	Ⓧ May be installed with glass up or down.
<b>J</b>	45939	NIL18, OZL18	(2) 10W (M)  	3000K, 92 CRI, 800 Lumens, 80 LPW	16.75W x 9.5H	7	6.75	Ⓧ Dimmable. May be installed with glass up or down.
<b>K</b>	45940	NI, OZ	(3) 100W (M)	---	23.75W x 9.25H	7	6.75	Ⓧ May be installed with glass up or down.
<b>K</b>	45940	NIL18, OZL18	(3) 10W (M)  	3000K, 92 CRI, 800 Lumens, 80 LPW	23.75W x 9.25H	7	6.75	Ⓧ Dimmable. May be installed with glass up or down.
<b>L</b>	45941	NI, OZ	(4) 100W (M)	---	34.75W x 9.25H	7	6.75	Ⓧ May be installed with glass up or down.
<b>L</b>	45941	NIL18, OZL18	(4) 10W (M)  	3000K, 92 CRI, 800 Lumens, 80 LPW	34.75W x 9.25H	7	6.75	Ⓧ Dimmable. May be installed with glass up or down.
<b>M</b>	45902	NI, OZ	(2) 100W (M)	---	14.75W x 9.25H	8.5	6.5	Ⓧ May be installed with glass up or down.
<b>M</b>	45902	NIL18, OZL18	(2) 10W (M)  	3000K, 92 CRI, 800 Lumens, 80 LPW	14.75W x 9.25H	8.5	6.5	Ⓧ Dimmable. May be installed with glass up or down.
<b>N</b>	45903	NI, OZ	(3) 100W (M)	---	23.25W x 9.25H	8.5	6.5	Ⓧ May be installed with glass up or down.
<b>N</b>	45903	NIL18, OZL18	(3) 10W (M)  	3000K, 92 CRI, 800 Lumens, 80 LPW	23.25W x 9.25H	8.5	6.5	Ⓧ Dimmable. May be installed with glass up or down.
<b>O</b>	45904	NI, OZ	(4) 100W (M)	---	30.5W x 9.25H	8.5	6.5	Ⓧ May be installed with glass up or down.
<b>O</b>	45904	NIL18, OZL18	(4) 10W (M)  	3000K, 92 CRI, 800 Lumens, 80 LPW	30.5W x 9.25H	8.5	6.5	Ⓧ Dimmable. May be installed with glass up or down.

Measurements shown in inches.

## For many, the day begins and ends with vanity lighting

Our customers count on the style they love to give the amount of light they need to prepare for their day. These incandescent options offer both style and quality.

Satin Etched Cased Opal Glass



**A** | 45496 CH, NI, OZ

Satin Etched Cased Opal Glass



**B** | 45497 CH, NI, OZ

Satin Etched Cased Opal Glass



**C** | 45498 CH, NI, OZ

Satin Etched Cased Opal Glass



**D** | 45889 NI, OZ

Satin Etched Cased Opal Glass



**E** | 45890 NI, OZ

Satin Etched Cased Opal Glass



**F** | 45891 NI, OZ

ITEM #	FINISH	LIGHT SOURCE	DIMENSIONS	EXT.	HCWO	NOTES
<b>A</b>	45496 CH, NI, OZ	(2) 100W (M)	15W x 8.75H	6.5	6.5	Ⓧ May be installed with glass up or down.
<b>B</b>	45497 CH, NI, OZ	(3) 100W (M)	23W x 8.75H	7	6.5	Ⓧ May be installed with glass up or down.
<b>C</b>	45498 CH, NI, OZ	(4) 100W (M)	31W x 8.75H	6.75	6.5	Ⓧ May be installed with glass up or down.
<b>D</b>	45889 NI, OZ	(2) 75W (M)	14.5W x 8H	6.5	5.5	Ⓧ May be installed with glass up or down.
<b>E</b>	45890 NI, OZ	(3) 75W (M)	24.25W x 8H	6.5	5.5	Ⓧ May be installed with glass up or down.
<b>F</b>	45891 NI, OZ	(4) 75W (M)	34W x 8H	6.5	5.5	Ⓧ May be installed with glass up or down.

Measurements shown in inches.



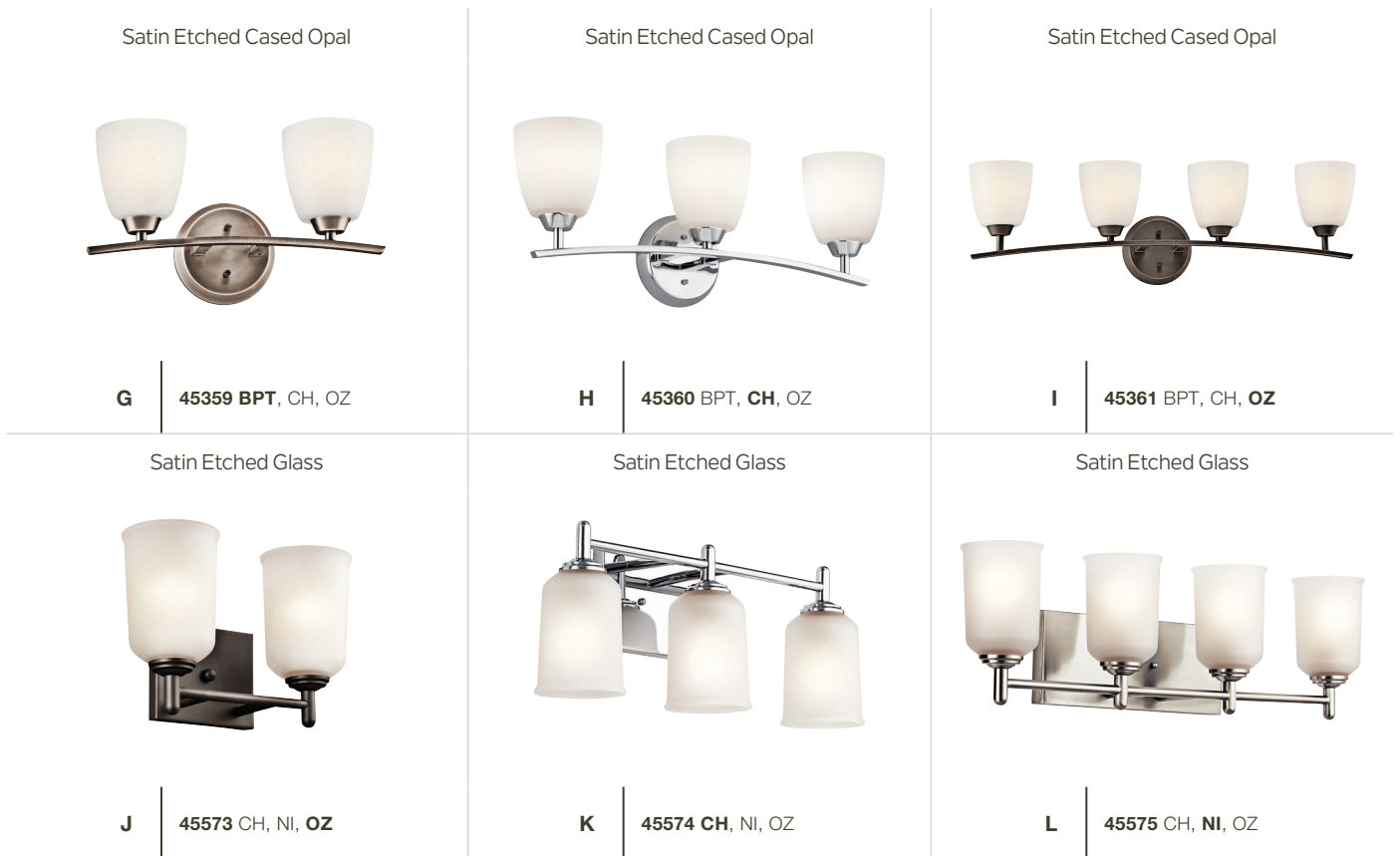

ITEM #	FINISH	LIGHT SOURCE	DIMENSIONS	EXT.	HCWO	NOTES
<b>G</b>	45359 BPT, CH, OZ	(2) 100W (M)	17W x 9.5H	6.5	6.5	Ⓧ May be installed with glass up or down.
<b>H</b>	45360 BPT, CH, OZ	(3) 100W (M)	25W x 9.5H	6.5	6.5	Ⓧ May be installed with glass up or down.
<b>I</b>	45361 BPT, CH, OZ	(4) 100W (M)	32.75W x 9.5H	6.75	6.5	Ⓧ May be installed with glass up or down.
<b>J</b>	45573 CH, NI, OZ	(2) 100W (M)	12.5W x 8.25H	6	5.25	Ⓧ May be installed with glass up or down.
<b>K</b>	45574 CH, NI, OZ	(3) 100W (M)	21W x 8.25H	6	5.25	Ⓧ May be installed with glass up or down.
<b>L</b>	45575 CH, NI, OZ	(4) 100W (M)	29.5W x 8.25H	6	5.25	Ⓧ May be installed with glass up or down.

Measurements shown in inches.

# Indoor Lighting

# Vanity

Satin Etched Glass



**A** | 5447 CH, NI, OZ

Satin Etched Glass



**B** | 5448 CH, NI, OZ

Satin Etched Glass



**C** | 5449 CH, NI, OZ

Clear Seeded Glass



**D** | 45885 NI, OZ

Clear Seeded Glass



**E** | 45886 NI, OZ

Clear Seeded Glass



**F** | 45887 NI, OZ

Clear Seeded Glass



**G** | 45591 AP, OZ

Clear Seeded Glass



**H** | 45592 AP, OZ

Clear Seeded Glass



**I** | 45593 AP, OZ

ITEM #	FINISH	LIGHT SOURCE	DIMENSIONS	EXT.	HCWO	NOTES
<b>A</b>	5447 CH, NI, OZ	(2) 100W (M)	14.75W x 8.75H	5.5	6.5	Ⓧ May be installed with glass up or down.
<b>B</b>	5448 CH, NI, OZ	(3) 100W (M)	23W x 8.75H	5.5	6.5	Ⓧ May be installed with glass up or down.
<b>C</b>	5449 CH, NI, OZ	(4) 100W (M)	31.25W x 8.75H	5.5	6.5	Ⓧ May be installed with glass up or down.
<b>D</b>	45885 NI, OZ	(2) 75W (M)	12.75W x 9.25H	6.5	7	Ⓧ May be installed with glass up or down.
<b>E</b>	45886 NI, OZ	(3) 75W (M)	21.5W x 9.25H	6.5	7	Ⓧ May be installed with glass up or down.
<b>F</b>	45887 NI, OZ	(4) 75W (M)	30W x 9.25H	6.5	7	Ⓧ May be installed with glass up or down.
<b>G</b>	45591 AP, OZ	(2) 100W (M)	14.75W x 10.75H	7.25	2.5	Ⓧ May be installed with glass up or down.
<b>H</b>	45592 AP, OZ	(3) 100W (M)	24W x 10.75H	7.25	2.5	Ⓧ May be installed with glass up or down.
<b>I</b>	45593 AP, OZ	(4) 100W (M)	33.25W x 10.75H	7.25	2.5	Ⓧ May be installed with glass up or down.

Measurements shown in inches.

= ADA Compliant 
 = DAMP 
 = WET 
 = Dark Sky Compliant 
 = LED Integrated 
 = Lamp Included 
 = CFL Lamp Included 
 = LED Bulb Included

Clear Glass



**J** | 45893 NI, OZ

Clear Glass



**K** | 45894 NI, OZ

Clear Glass



**L** | 45895 NI, OZ

Satin Etched White Glass



**M** | 45450 AP, MIZ

Satin Etched White Glass



**N** | 45451 AP, MIZ

Satin Etched White Glass



**O** | 45452 AP, MIZ

Satin Etched Cased Opal Glass



**P** | 45596 AP, OZ

Satin Etched Cased Opal Glass



**Q** | 45597 AP, OZ

Satin Etched Cased Opal Glass



**R** | 45598 AP, OZ

ITEM #	FINISH	LIGHT SOURCE	DIMENSIONS	EXT.	HCWO	NOTES
<b>J</b>	45893 NI, OZ	(2) 75W (M)	15.5W x 8.25H	7.75	6	Ⓧ May be installed with glass up or down.
<b>K</b>	45894 NI, OZ	(3) 75W (M)	24.5W x 8.25H	7.5	6	Ⓧ May be installed with glass up or down.
<b>L</b>	45895 NI, OZ	(4) 75W (M)	33.5W x 8.25H	7.5	6	Ⓧ May be installed with glass up or down.
<b>M</b>	45450 AP, MIZ	(2) 60W (C)	12.5W x 7.5H	6.5	3.75	Ⓧ White translucent organza shade with brown or gray trim.
<b>N</b>	45451 AP, MIZ	(3) 60W (C)	20.5W x 7.5H	6.75	3.75	Ⓧ White translucent organza shade with brown or gray trim.
<b>O</b>	45452 AP, MIZ	(4) 60W (C)	28.25W x 7.5H	6.75	3.75	Ⓧ White translucent organza shade with brown or gray trim.
<b>P</b>	45596 AP, OZ	(2) 100W (M)	15W x 9.25H	6.25	6.75	Ⓧ May be installed with glass up or down.
<b>Q</b>	45597 AP, OZ	(3) 100W (M)	23W x 9.25H	6.25	6.75	Ⓧ May be installed with glass up or down.
<b>R</b>	45598 AP, OZ	(4) 100W (M)	31.5W x 9H	6.25	6.75	Ⓧ May be installed with glass up or down.

Measurements shown in inches.

# Indoor Lighting

# Vanity

Etched Seeded Glass



**A** | 6322 NI, TZ

Etched Seeded Glass



**B** | 6323 NI, TZ

Etched Seeded Glass



**C** | 6324 NI, TZ

Satin Etched Glass



**D** | 45882 NI, OZ

Satin Etched Glass



**E** | 45883 NI, OZ

Satin Etched Glass



**F** | 45884 NI, OZ

CH, NI: Alabaster Swirl Glass  
OZ: Umber Etched Glass



**G** | 5992 CH, NI, OZ

CH, NI: Alabaster Swirl Glass  
OZ: Umber Etched Glass



**H** | 5993 CH, NI, OZ

CH, NI: Alabaster Swirl Glass  
OZ: Umber Etched Glass



**I** | 5994 CH, NI, OZ

ITEM #	FINISH	LIGHT SOURCE	DIMENSIONS	EXT.	HCWO	NOTES
<b>A</b>	6322 NI, TZ	(2) 100W (M)	14.25W x 8.75H	8	2.5	Ⓧ May be installed with glass up or down.
<b>B</b>	6323 NI, TZ	(3) 100W (M)	22.5W x 7.75H	8	5.25	Ⓧ May be installed with glass up or down.
<b>C</b>	6324 NI, TZ	(4) 100W (M)	30.5W x 9H	8	6.25	Ⓧ May be installed with glass up or down.
<b>D</b>	45882 NI, OZ	(2) 100W (M)	16W x 10H	8.5	5	Ⓧ May be installed with glass up or down.
<b>E</b>	45883 NI, OZ	(3) 100W (M)	24W x 10H	8.5	5	Ⓧ May be installed with glass up or down.
<b>F</b>	45884 NI, OZ	(4) 100W (M)	33W x 10H	8.5	5	Ⓧ May be installed with glass up or down.
<b>G</b>	5992 CH, NI, OZ	(2) 100W (M)	18W x 9H	9	5	Ⓧ May be installed with glass up or down.
<b>H</b>	5993 CH, NI, OZ	(3) 100W (M)	24.75W x 9H	9	5	Ⓧ May be installed with glass up or down.
<b>I</b>	5994 CH, NI, OZ	(4) 100W (M)	33.25W x 9H	9	5	Ⓧ May be installed with glass up or down.

Measurements shown in inches.

= ADA Compliant 
 = DAMP 
 = WET 
 = Dark Sky Compliant 
 = LED Integrated 
 = Lamp Included 
 = CFL Lamp Included 
 = LED Bulb Included

NI: White Scavo Glass  
OZ: White Scavo W/Light Umber Inside Tint



**J** | 45422 NI, OZ

NI: White Scavo Glass  
OZ: White Scavo W/Light Umber Inside Tint



**K** | 45423 NI, OZ

NI: White Scavo Glass  
OZ: White Scavo W/Light Umber Inside Tint



**L** | 45424 NI, OZ

Cased Opal Glass



**M** | 6122 CH, NI

Cased Opal Glass



**N** | 6123 CH, NI

Cased Opal Glass



**O** | 6124 CH, NI

Satin Etched Glass



**P** | 5336 CHS, NIS, TZS

Satin Etched Glass



**Q** | 5337 CHS, NIS, TZS

Satin Etched Glass



**R** | 5338 CHS, NIS, TZS



**S** | 5339 CHS, NIS, TZS

	ITEM #	FINISH	LIGHT SOURCE	DIMENSIONS	EXT.	HCWO	NOTES
<b>J</b>	45422	NI, OZ	(2) 100W (M)	18W x 9H	8.25	5	Ⓧ May be installed with glass up or down.
<b>K</b>	45423	NI, OZ	(3) 100W (M)	24W x 9H	8.25	5	Ⓧ May be installed with glass up or down.
<b>L</b>	45424	NI, OZ	(4) 100W (M)	36W x 9H	8.25	5	Ⓧ May be installed with glass up or down.
<b>M</b>	6122	CH, NI	(2) 100W (M)	13.5W x 8.5H	6.75	3.75	Ⓧ May be installed with glass up or down.
<b>N</b>	6123	CH, NI	(3) 100W (M)	18W x 8.75H	9.25	3.25	Ⓧ May be installed with glass up or down.
<b>O</b>	6124	CH, NI	(4) 100W (M)	25.5W x 8.5H	10.25	3.25	Ⓧ May be installed with glass up or down.
<b>P</b>	5336	CHS, NIS, TZS	(2) 100W (M)	12.25W x 8H	8	3.5	Ⓧ May be installed with glass up or down.
<b>Q</b>	5337	CHS, NIS, TZS	(3) 100W (M)	24W x 8H	8	3.5	Ⓧ May be installed with glass up or down.
<b>R</b>	5338	CHS, NIS, TZS	(4) 100W (M)	30W x 8H	8	3.5	Ⓧ May be installed with glass up or down.
<b>S</b>	5339	CHS, NIS, TZS	(5) 100W (M)	36W x 8H	8	3.5	Ⓧ May be installed with glass up or down.

Measurements shown in inches.

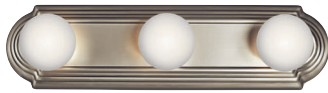

**A** | 5003 CH, NI, TZ



**B** | 5017 CH, NI, TZ



**C** | 5018 CH, NI, TZ



**D** | 5019 CH, NI, TZ



**E** | 623 CH, NI



**F** | 624 CH, NI



**G** | 625 CH, NI



**H** | 626 CH, NI



**I** | 628 CH, NI

ITEM #	FINISH	LIGHT SOURCE	DIMENSIONS	EXT.	HCWO	NOTES	
A	5003	CH, NI, TZ	(3) 60W (M)	18W x 4.75H	5.5	2.25	Ⓧ May be installed vertically or horizontally. Extension includes bulbs. G-25 lamp recommended.
B	5017	CH, NI, TZ	(4) 60W (M)	24W x 4.75H	5.5	2.25	Ⓧ May be installed vertically or horizontally. Extension includes bulbs. G-25 lamp recommended.
C	5018	CH, NI, TZ	(6) 60W (M)	36W x 4.75H	5.5	2.25	Ⓧ May be installed vertically or horizontally. Extension includes bulbs. G-25 lamp recommended.
D	5019	CH, NI, TZ	(8) 60W (M)	48W x 4.75H	5.5	2.25	Ⓧ May be installed vertically or horizontally. Extension includes bulbs. G-25 lamp recommended.
E	623	CH, NI	(3) 60W (M)	18W x 4.5H	5.5	2.25	Ⓧ May be installed vertically or horizontally. Extension includes bulbs. G-25 lamp recommended.
F	624	CH, NI	(4) 60W (M)	24W x 4.5H	5.5	2.25	Ⓧ May be installed vertically or horizontally. Extension includes bulbs. G-25 lamp recommended.
G	625	CH, NI	(5) 60W (M)	30W x 4.5H	5.5	2.25	Ⓧ May be installed vertically or horizontally. Extension includes bulbs. G-25 lamp recommended.
H	626	CH, NI	(6) 60W (M)	36W x 4.5H	5.5	2.25	Ⓧ May be installed vertically or horizontally. Extension includes bulbs. G-25 lamp recommended.
I	628	CH, NI	(8) 60W (M)	48W x 4.5H	5.5	2.25	Ⓧ May be installed vertically or horizontally. Extension includes bulbs. G-25 lamp recommended.

Measurements shown in inches.

= ADA Compliant 
 = DAMP 
 = WET 
 = Dark Sky Compliant 
 = LED Integrated 
 = Lamp Included 
 = CFL Lamp Included 
 = LED Bulb Included

# LED Mirrors



Ideal for hospitality projects, these élan LED mirrors offer soft, yet powerful illumination through etched panels

Select models also feature a Bluetooth® soundbar to heighten the senses with the addition of sound

Bluetooth LED Mirror

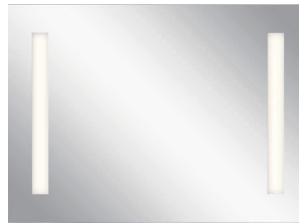

**A** | **84000**

Bluetooth LED Mirror

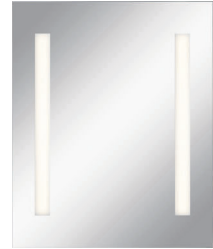

**B** | **83999**

LED Mirror



**C** | **83993**

LED Mirror



**D** | **83992**

LED Mirror



**E** | **84003**

LED Mirror



**F** | **83997**

LED Mirror



**G** | **83998**

ITEM #	LED SOURCE	DIMENSIONS	EXT.	HCWO	NOTES
<b>A</b>	84000	LED	36W x 26H	2.5	Ⓧ Install horizontal only.
<b>B</b>	83999	LED	26W x 32H	2.5	Ⓧ Install vertical only.
<b>C</b>	83993	LED	19.75W x 35.5H	2	Ⓧ Install vertical only.
<b>D</b>	83992	LED	27W x 42H	3	Ⓧ May be installed vertically or horizontally.
<b>E</b>	84003	LED	54W x 42H	3	Ⓧ May be installed vertically or horizontally.
<b>F</b>	83997	LED	39W x 27H	1	Ⓧ May be installed vertically or horizontally.
<b>G</b>	83998	LED	39W x 25H	1	Ⓧ May be installed vertically or horizontally.

For additional style and finish options, visit [elan-lighting.com](http://elan-lighting.com), or contact your local sales representative.

Measurements shown in inches.



**A** | 83454 SW



**B** | 83455 SB



**C** | 83261 NI



**D** | 83260 NI



**E** | 83453 SB



**F** | 83452 SW

Clear glass with matte white acrylic diffuser

Clear glass with matte white acrylic diffuser



**G** | 83671 NI



**H** | 83670 NI

ITEM #	FINISH	LIGHT SOURCE	LED FIXTURE OUTPUT	DIMENSIONS	ADJUST MAX. HT.	NOTES
A	83454 SW	38W	3800K, 80-85 CRI, 1220 Lumens, 32 LPW	23.5W x 2.75H	113	Dimmable.
B	83455 SB	38W	3800K, 80-85 CRI, 1220 Lumens, 32 LPW	23.5W x 2.75H	113	Dimmable.
C	83261 NI	38W	3800K, 80-85 CRI, 1220 Lumens, 32 LPW	23.5W x 2.75H	113	Dimmable.
D	83260 NI	28W	3800K, 80-85 CRI, 920 Lumens, 33 LPW	17.75W x 2.25H	112.5	Dimmable.
E	83453 SB	28W	3800K, 80-85 CRI, 920 Lumens, 33 LPW	17.75W x 2.25H	112.5	Dimmable.
F	83452 SW	28W	3800K, 80-85 CRI, 920 Lumens, 33 LPW	17.75W x 2.25H	112.5	Dimmable.
G	83671 NI	21W	3000K, 79.3 CRI, 1416 Lumens, 67 LPW	19.5W x .75H	96.5	Dimmable.
H	83670 NI	45W	3000K, 79 CRI, 3230 Lumens, 77 LPW	25W x .75H	96.5	Dimmable.

Measurements shown in inches.

For additional style and finish options, visit [elan-lighting.com](http://elan-lighting.com), or contact your local sales representative.

= ADA Compliant = DAMP = WET = Dark Sky Compliant = LED Integrated = Lamp Included = CFL Lamp Included = LED Bulb Included



# Mini Pendants – LED

Clear glass with inner white metal filigree



**I** | **83490 CH**

Clear glass with inner white metal filigree



**J** | **83492 CH**

K9 bubble crystal with faceted edge



**K** | **83493 CH**

Clear cubic zirconia chip













**L** | **83690 NI**

Smoke glass



**M** | **83791 CH**

ITEM #	FINISH	LIGHT SOURCE	LED FIXTURE OUTPUT	DIMENSIONS	ADJUST MAX. HT.	NOTES
<b>I</b>   83490	CH	6W  	3200K, 84 CRI, 298 Lumens, 50 LPW	3.25W x 11.75H	97.25	Dimmable.
<b>J</b>   83492	CH	6W  	3200K, 83.3 CRI, 359 Lumens, 60 LPW	4W x 10.25H	96.75	Dimmable.
<b>K</b>   83493	CH	6W  	3200K, 80.9 CRI, 405 Lumens, 68 LPW	2.25W x 10.5H	96.75	Dimmable.
<b>L</b>   83690	NI	5W  	3200K, 84.3 CRI, 364 Lumens, 73 LPW	6.75W x 7.25H	115	Dimmable.
<b>M</b>   83791	CH	5W  	3200K, 82.6 CRI, 230 Lumens, 46 LPW	11.75W x 9.75H	105.75	Dimmable.

For additional style and finish options, visit [elan-lighting.com](http://elan-lighting.com), or contact your local sales representative.

Measurements shown in inches.



Add an efficient light source to any reception desk, restaurant bar, or kitchen island with integrated LED Pendants

Offering excellent light output, these seemingly simple styles each offer a subtle design element – making them both unique and universally appealing

For fixtures with LED, Energy Star® Rated light bulbs included, look for “L18” in the model number



Striated Satin Etched Cased Opal Glass



**A** | 11252 NILED



**B** | 11301 NILED

Satin Etched Cased Opal Glass



**C** | 11314 NILED



**D** | 11305 NILED

Satin Etched Cased Opal Glass



**E** | 43927 NI, OZ  
43927 NIL18, OZL18

Satin Etched Cased Opal Glass



**F** | 43668 NI, OZ  
43668 NIL18, OZL18

ITEM #	FINISH	LIGHT SOURCE	LED BULB OUTPUT	DIMENSIONS	OVRLL. H	STEM TILT	EXTRA WIRE	CHAIN/STEM	NOTES	
<b>A</b>	11252	NILED	(1) 8W	3000K, 90 CRI, 450 Lumens, 56 LPW	4W x 9.25H	47	90	74	36	Dimmable.
<b>B</b>	11301	NILED	(1) 8W	3000K, 90 CRI, 500 Lumens, 63 LPW	7W x 7.25H	45	90	74	36	Dimmable.
<b>C</b>	11314	NILED	(1) 8W	3000K, 90 CRI, 375 Lumens, 47 LPW	6W x 9H	47	90	74	36	Dimmable.
<b>D</b>	11305	NILED	(1) 8W	3000K, 90 CRI, 450 Lumens, 56 LPW	4.5W x 9.25H	47	90	74	36	Dimmable.
<b>E</b>	43927	NI, OZ	(1) 100W (M)	---	4W x 19H	57	90	55	36	Additional stem 4935 NI, OZ.
<b>E</b>	43927	NIL18, OZL18	(1) 10W (M)	3000K, 92 CRI, 800 Lumens, 80 LPW	4W x 19H	57	90	55	36	Dimmable. Additional stem 4935 NI, OZ
<b>F</b>	43668	NI, OZ	(1) 100W (M)	---	4.75W x 12.75H	51	-	63	36	Add. chain 2996 NI, OZ. Sloped ceiling kit incl.
<b>F</b>	43668	NIL18, OZL18	(1) 10W (M)	3000K, 92 CRI, 800 Lumens, 80 LPW	4.75W x 12.75H	51	-	63	36	Dimmable. Add. chain 2996 NI, OZ. Sloped ceiling kit incl.

Measurements shown in inches. A, B, C, D, & F: Additional stem 2997, 2999, 3036, 3048.



# Mini Pendants – LED Options



ITEM #	FINISH	LIGHT SOURCE	LED BULB OUTPUT	DIMENSIONS	OVRL. H	STEM TILT	EXTRA WIRE	CHAIN/STEM	NOTES
<b>G</b> 43077	NI, OZ	(1) 100W (M)	---	4.75W x 8H	46	-	68	36	Add. chain 2996 NI, OZ.
<b>G</b> 43077	NIL18, OZL18	(1) 10W (M)	3000K, 92 CRI, 800 Lumens, 80 LPW	4.75W x 8H	46	-	68	36	Dimmable. Add. chain 2996 NI, OZ.
<b>H</b> 3497	NI, OZS	(1) 100W (M)	---	4.5W x 8H	46	-	68	36	Add. chain 2996 NI, OZ. Sloped ceiling kit included.
<b>H</b> 3497	NIL18, OZSL18	(1) 10W (M)	3000K, 92 CRI, 800 Lumens, 80 LPW	4.5W x 8H	46	-	68	36	Dimmable. Add. chain 2996 NI, OZ. Sloped ceiling kit included.
<b>I</b> 43640	NI, OZ	(1) 100W (M)	---	4.75W x 12.5H	51	-	40	36	Add. chain 2996 NI, OZ.
<b>I</b> 43640	NIL18, OZL18	(1) 10W (M)	3000K, 92 CRI, 800 Lumens, 80 LPW	4.75W x 12.25H	51	-	40	36	Dimmable. Add. chain 2996 NI, OZ.
<b>J</b> 3482	NI, OZ	(1) 100W (M)	---	7W x 7.75H	47	90	68	36	
<b>J</b> 3482	NIL18, OZL18	(1) 10W (M)	3000K, 92 CRI, 800 Lumens, 80 LPW	7W x 7.75H	47	90	68	36	Dimmable.
<b>K</b> 43511	NI, OZ	(1) 100W (M)	---	6W x 6.75H	45	90	68	36	
<b>K</b> 43511	NIL18, OZL18	(1) 10W (M)	3000K, 92 CRI, 800 Lumens, 80 LPW	6W x 6.75H	45	90	68	36	Dimmable.
<b>L</b> 42901	NI, OZ	(1) 100W (M)	---	6.25W x 15H	89	-	25	72	Add. chain 2996 NI, OZ.
<b>L</b> 42901	NIL18, OZL18	(1) 10W (M)	3000K, 92 CRI, 800 Lumens, 80 LPW	6.25W x 15H	89	-	25	72	Dimmable. Add. chain 2996 NI, OZ.
<b>M</b> 43941	NI, OZ	(1) 100W (M)	---	6.5W x 13.25H	53	-	67	36	Add. chain 2996 NI, OZ.
<b>M</b> 43941	NIL18, OZL18	(1) 10W (M)	3000K, 92 CRI, 800 Lumens, 80 LPW	6.5W x 13.25H	53	-	67	36	Dimmable. Add. chain 2996 NI, OZ.
<b>N</b> 43162	NI, OZ	(1) 100W (M)	---	7W x 16H	54	90	60	36	
<b>N</b> 43162	NIL18, OZL18	(1) 10W (M)	3000K, 92 CRI, 800 Lumens, 80 LPW	7W x 16H	54	90	60	36	Dimmable.

G, H, J, K, M, N: Additional stem 2997, 2999, 3036, 3048 NI, 2999 OZ.

Measurements shown in inches.

# Indoor Lighting

# Pendants – LED Options

Satin Etched White Glass



**A** | 3299 NI, OZS  
3299 NIL18, OZSL18

Satin Etched White Glass



**B** | 3384 NI, OZ  
3384 NIL18, OZL18

NI: Satin Etched Glass  
OZ: Light Umber Etched Glass



**C** | 43163 NI, OZ  
43163 NIL18, OZL18

NI: Satin Etched Glass  
OZ: Light Umber Etched Glass



**D** | 43164 NI, OZ  
43164 NIL18, OZL18

Satin Etched Glass



**E** | 42903 NI, OZ  
42903 NIL18, OZL18

Satin Etched Glass

















**F** | 42902 NI, OZ  
42902 NIL18, OZL18





Satin Etched White Glass



**G** | 43076 NI, OZ  
43076 NIL18, OZL18

ITEM #	FINISH	LIGHT SOURCE	LED BULB OUTPUT	DIMENSIONS	OVRL. H	EXTRA WIRE	CHAIN/STEM	NOTES
A 3299	NI, OZS	(4) 150W (M)	---	25.75W x 26.25H	64	91	36	Add. chain 2996 NI, OZ. Add. stem 2997, 2999, 3036, 3048 NI, 2999 OZ.
A 3299	NIL18, OZSL18	(4) 10W (M)  	3000K, 92 CRI, 800 Lumens, 80 LPW	25.75W x 26.25H	64	91	36	Dimmable. Add. chain 2996 NI, OZ. Add. stem 2997, 2999, 3036, 3048 NI, 2999 OZ.
B 3384	NI, OZ	(3) 100W (M)	---	22W x 25.5H	100	20	72	Add. chain 2996 NI, OZ.
B 3384	NIL18, OZL18	(3) 10W (M)  	3000K, 92 CRI, 800 Lumens, 80 LPW	22W x 25.5H	100	20	72	Dimmable. Add. chain 2996 NI, OZ.
C 43163	NI, OZ	(2) 100W (M)	---	17.5W x 24.75H	99	20	72	Add. chain 2996 NI, OZ.
C 43163	NIL18, OZL18	(2) 10W (M)  	3000K, 92 CRI, 800 Lumens, 80 LPW	17.5W x 24.75H	99	20	72	Dimmable. Add. chain 2996 NI, OZ.
D 43164	NI, OZ	(3) 100W (M)	---	26.75W x 32.75H	107	14	72	Add. chain 2996 NI, OZ.
D 43164	NIL18, OZL18	(3) 10W (M)  	3000K, 92 CRI, 800 Lumens, 80 LPW	26.75W x 32.75H	107	14	72	Dimmable. Add. chain 2996 NI, OZ.
E 42903	NI, OZ	(3) 100W (M)	---	18W x 21.75H	96	23	72	Add. chain 2996 NI, OZ.
E 42903	NIL18, OZL18	(3) 10W (M)  	3000K, 92 CRI, 800 Lumens, 80 LPW	18W x 21.75H	96	23	72	Dimmable. Add. chain 2996 NI, OZ.
F 42902	NI, OZ	(1) 150W (M)	---	14W x 10.5H	85	30	72	Add. chain 2996 NI, OZ.
F 42902	NIL18, OZL18	(1) 10W (M)  	3000K, 92 CRI, 800 Lumens, 80 LPW	14W x 10.5H	85	30	72	Dimmable. Add. chain 2996 NI, OZ.
G 43076	NI, OZ	(1) 100W (M)	---	12.75W x 24.25H	63	64	36	Add. chain 2996 NI, OZ.
G 43076	NIL18, OZL18	(1) 10W (M)  	3000K, 92 CRI, 800 Lumens, 80 LPW	12.75W x 24.25H	63	64	36	Dimmable. Add. chain 2996 NI, OZ.

Measurements shown in inches.

 = ADA Compliant  = DAMP  = WET  = Dark Sky Compliant  = LED Integrated  = Lamp Included  = CFL Lamp Included  = LED Bulb Included



# Indoor Lighting

## Mini Pendants

Clear Seeded Glass



**A** | 42588 NI, OZ

Mercury Glass



**B** | 42167 NIMER, OZMER

Clear Seeded Glass



**C** | 43850 CH, NI, OZ

Clear Seeded Glass



**D** | 43851 NI, OZ

Clear Seeded Glass



**E** | 43853 CH, NI, OZ

Clear Seeded Glass



**F** | 43852 NI, OZ

Clear Glass



**G** | 42878 NI, OZ

Clear Fresnel Glass



**H** | 42436 AP, OZ

Clear Seeded Glass



**I** | 2664 OZ, PN

ITEM #	FINISH	LIGHT SOURCE	DIMENSIONS	OVRL. H	STEM TILT	EXTRA WIRE	CHAIN/STEM	NOTES
<b>A</b> 42588	NI, OZ	(2) 60W (C)	10W x 12H	50	---	59	36	Add. chain 2996 NI, OZ. Add. stem 2997, 2999, 3036, 3048 NI, 2999 OZ. Sloped ceiling kit incl.
<b>B</b> 42167	NIMER, OZMER	(1) 100W (M)	9.5W x 9.25H	48	90°	66	36	Add. stem 2997, 2999, 3036, 3048 NI, OZ.
<b>C</b> 43850	CH, NI, OZ	(1) 100W (M)	8W x 8.5H	125	---	---	---	
<b>D</b> 43851	NI, OZ	(1) 100W (M)	8.25W x 8.75H	125	---	---	---	
<b>E</b> 43853	CH, NI, OZ	(1) 100W (M)	10W x 9.25H	125	---	---	---	
<b>F</b> 43852	NI, OZ	(1) 100W (M)	9.75W x 11.25H	128	---	---	---	
<b>G</b> 42878	NI, OZ	(1) 100W (M)	4.75W x 7.75H	113	---	---	---	
<b>H</b> 42436	AP, OZ	(1) 60W (M)	10W x 8.5H	47	---	70	36	Add. chain 2996 AP, OZ. Add. stem 2999 AP, OZ. Sloped Ceiling kit incl.
<b>I</b> 2664	OZ, PN	(1) 100W (M)	8W x 10.25H	49	---	71	36	Add. chain 2996 OZ, PN. Add. stem 2999 OZ, PN. Sloped Ceiling kit incl.

Measurements shown in inches.

= ADA Compliant 
 = DAMP 
 = WET 
 = Dark Sky Compliant 
 = LED Integrated 
 = Lamp Included 
 = CFL Lamp Included 
 = LED Bulb Included

Clear Seeded Glass



**J** | 43949 CLP, NBR

Clear Glass



**K** | 42798 NI, OZ

Clear Seeded Glass



**L** | 44058 OZ



**M** | 44196 MBK

Clear Glass



**N** | 43996 CH, NI, OZ

Clear Seeded Glass



**O** | 44032 NI, OZ

Clear Glass



**P** | 44065 NI, OZ

AP - Satin Etched White glass with White Translucent Organza shade.  
MIZ - Satin Etched White glass with Light Umber Translucent Organza shade.



**Q** | 43152 AP, MIZ

Satin Etched Cased Opal Glass



**R** | 42562 BPT, OZ

	ITEM #	FINISH	LIGHT SOURCE	DIMENSIONS	OVRL. H	STEM TILT	EXTRA WIRE	CHAIN/STEM	NOTES
<b>J</b>	43949	CLP, NBR	(1) 100W (M)	5W x 8.5H	47	---	68	36	Add. chain 2996 CLP, NBR. Add. stem 2999 CLP, NBR. Sloped ceiling kit incl.
<b>K</b>	42798	NI, OZ	(1) 75W (M)	9.5W x 10.75H	49	90°	68	36	Add. stem 2997, 2999, 3036, 3048 NI, 2999 OZ.
<b>L</b>	44058	OZ	(1) 75W (M)	9W x 8.75H	47	---	66	36	Add. chain 2996 OZ. Add. stem 2999 OZ. Sloped ceiling kit incl.
<b>M</b>	44196	MBK	(1) 75W (M)	10W x 11H	49	90°	68	36	Add. stem 2999 MBK.
<b>N</b>	43996	CH, NI, OZ	(1) 100W (M)	6W x 10.75H	49	90°	68	36	Add. stem 2999, 3036, 3048 CH, NI, OZ.
<b>O</b>	44032	NI, OZ	(1) 75W (M)	4.25W x 7H	45	90°	68	36	Add. stem 2997, 2999, 3036, 3048 NI, OZ.
<b>P</b>	44065	NI, OZ	(1) 75W (M)	6.5W x 7.75H	51	90°	64	36	Add. chain 2996 OZ. Add. stem 2997, 2999, 3036, 3048 NI, 2999 OZ.
<b>Q</b>	43152	AP, MIZ	(1) 50W (G9)	6W x 6.25H	44	90°	68	36	Add. stem 2999 AP, MIZ. Shades: White Organza with Gray, or Light Umber with Brown trim
<b>R</b>	42562	BPT, OZ	(1) 100W (M)	5.25W x 6.75H	45	---	68	36	Add. chain 2996 BPT, OZ. Add. stem 2999 BPT, OZ. Sloped ceiling kit incl.

Measurements shown in inches.

# Indoor Lighting

## Mini Pendants/Pendants

Satin Etched Cased Opal Glass



**A** | 44053 NI, OZ

Satin Etched Glass



**B** | 43674 NI, OZ

Satin Etched Cased Opal Glass



**C** | 43394 AP, OZ

Satin Etched Glass



**D** | 42880 NI, OZ

Etched Seeded Glass



**E** | 2771 NI, TZ

Satin Etched Glass



**F** | 2693 NI, OZ

NI: Alabaster Swirl Glass  
OZ: Umber Etched Glass



**G** | 3476 NI, OZ

Satin Etched Glass



**H** | 3345 NI

NI: White Scavo Glass  
OZ: White Scavo Glass with Light Umber Tint



**I** | 43230 NI, OZ

	ITEM #	FINISH	LIGHT SOURCE	DIMENSIONS	OVRLL. H	STEM TILT	EXTRA WIRE	CHAIN/STEM	NOTES
<b>A</b>	44053	NI, OZ	(1) 75W (M)	4.75W x 7.25H	45	90°	67	36	
<b>B</b>	43674	NI, OZ	(1) 100W (M)	4.25W x 11H	49	---	68	36	Additional chain 2996 NI, OZ. Sloped ceiling kit included.
<b>C</b>	43394	AP, OZ	(1) 100W (M)	8W x 15.5H	54	90°	62	36	Additional stem 2999 AP, OZ.
<b>D</b>	42880	NI, OZ	(1) 100W (M)	6W x 8H	82	---	31	72	Additional chain 2996 NI, OZ.
<b>E</b>	2771	NI, TZ	(1) 100W (M)	6.5W x 5.5H	46	---	68	36	Additional chain 2996 NI, TZ. Sloped ceiling kit included.
<b>F</b>	2693	NI, OZ	(1) 100W (M)	6W x 6H	44	90°	58	36	
<b>G</b>	3476	NI, OZ	(1) 100W (M)	7.25W x 6.75H	45	---	67	36	Additional chain 2996 NI, OZ.
<b>H</b>	3345	NI	(1) 100W (M)	4.75W x 13.75H	88	---	31	72	Additional chain 2996 NI.
<b>I</b>	43230	NI, OZ	(1) 100W (M)	7W x 16.5H	55	90°	52	36	

Measurements shown in inches. A, B, E, F, G, I: Additional stem 2997, 2999, 3036, 3048 NI, 2999 OZ.

= ADA Compliant 
 = DAMP 
 = WET 
 = Dark Sky Compliant 
 = LED Integrated 
 = Lamp Included 
 = CFL Lamp Included 
 = LED Bulb Included





	ITEM #	FINISH	LIGHT SOURCE	DIMENSIONS	OVRL. H	STEM TILT	EXTRA WIRE	CHAIN/STEM	NOTES
<b>J</b>	42475	CHCLR, NIMER, OZMER	(1) 100W (M)	11W x 29.5H	68	90°	54	36	Add. Stem 2997,2999, 3036, 3048 NI, 2999 CH, OZ.
<b>K</b>	42456	CHCLR, OZCLR, OZCP	(1) 100W (M)	7W x 13.75H	52	90°	64	36	Add. stem 2999 CH, OZ.
<b>L</b>	43953	NI, OZ	(1) 100W (M)	9W x 16H	46	---	62	36	Add. chain 2996 NI, OZ. Add. Stem 2997,2999, 3036, 3048 NI, 2999 OZ. Sloped ceiling kit incl.
<b>M</b>	43954	NI, OZ	(1) 100W (M)	7.75W x 13.75H	52	---	66	36	Add. chain 2996 NI, OZ. Add. Stem 2997,2999, 3036, 3048 NI, 2999 OZ. Sloped ceiling kit incl.
<b>N</b>	43955	NI, OZ	(1) 100W (M)	11.5W x 13H	51	---	66	36	Add. chain 2996 NI, OZ. Add. Stem 2997,2999, 3036, 3048 NI, 2999 OZ. Sloped ceiling kit incl.

Measurements shown in inches.

Clear Glass



**A** 42141 OZCLR

Clear Seeded Glass



**A** 42141 OZCS

Clear Glass



**A** 42141 CHCLR

Clear Seeded Glass

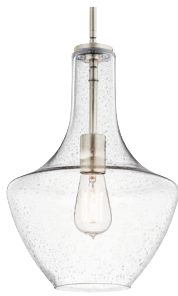

**A** 42141 NICS



**B** 43982 BK



**C** 43984 BK

Clear Glass



**D** 42890 NI, OZ

Clear Glass



**E** 42877 NI, OZ

Clear Glass



**F** 42869 NI, OZ

ITEM #	FINISH	LIGHT SOURCE	DIMENSIONS	OVRL H	STEM TILT	EXTRA WIRE	CHAIN/STEM	NOTES
<b>A</b> 42141	OZCLR, OZCS, CHCLR, NICS	(1) 100W (M)	10.5W x 15.25H	54	90°	63	36	Add. Stem 2997, 2999, 3036, 3048 NI, 2999 CH, OZ.
<b>B</b> 43982	BK	(1) 100W (M)	12W x 13H	51	---	71	36	Add. chain 4927 BK. Add. stem 2999 BK. Sloped ceiling kit incl.
<b>C</b> 43984	BK	(4) 100W (M)	18W x 16.5H	55	---	64	36	Add. chain 4927 BK. Add. stem 2999 BK. Sloped ceiling kit incl.
<b>D</b> 42890	NI, OZ	(8) 100W (M)	10.25W x 7.75H x 25.5L	124	---	---	---	
<b>E</b> 42877	NI, OZ	(6) 100W (M)	12W x 7.75H	124	---	---	---	
<b>F</b> 42869	NI, OZ	(3) 100W (M)	8.5W x 7.75H	124	---	---	---	

Measurements shown in inches.



**G** | 2713 NI, OB



**H** | 42649 OZ

Clear Fresnel Lens



**I** | 42437 AP, OZ

Fresnel Lens



**J** | 2666 OZ, PN

Fresnel Lens



**K** | 2665 OZ, PN



**L** | 43998 CH, NI, OZ

AP - White Translucent Organza Shade.  
MIZ - Light Umber Translucent Organza Shade.



**M** | 43139 AP, MIZ



**N** | 43940 NI, OZ



**O** | 43165 NI, OZ

ITEM #	FINISH	LIGHT SOURCE	DIMENSIONS	OVRL. H	EXTRA WIRE	CHAIN/STEM	NOTES
<b>G</b> 2713	NI, OB	(1) 150W (M)	16W x 13.25H	88	36	72	Add. chain 2996 NI, OB. G type lamp recommended.
<b>H</b> 42649	OZ	(3) 100W (M)	20W x 9.5H	48	62	36	Add. chain 2996 OZ. Add. stem 2999 OZ. Sloped ceiling kit incl.
<b>I</b> 42437	AP, OZ	(1) 75W (M)	12W x 9.25H	48	70	36	Add. chain 2996 AP, OZ. Add. stem 2999 AP, OZ. Sloped ceiling kit incl.
<b>J</b> 2666	OZ, PN	(1) 150W (M)	13.25W x 12H	50	71	36	Add. chain 2996 OZ, PN. Add. stem 2999 OZ, PN. Sloped ceiling kit incl.
<b>K</b> 2665	OZ, PN	(1) 100W (M)	11.75W x 11H	49	71	36	Add. chain 2996 OZ, PN. Add. stem 2999 OZ, PN. Sloped ceiling kit incl.
<b>L</b> 43998	CH, NI, OZ	(4) 60W (C)	16W x 31H	105	14	72	Add. chain 2996 CH, NI, OZ.
<b>M</b> 43139	AP, MIZ	(3) 60W (C)	20W x 31H	105	23	72	Add. chain 2996 AP, MIZ.
<b>N</b> 43940	NI, OZ	(4) 60W (C)	13.5W x 25H	99	56	72	Add. chain 2996 NI, OZ.
<b>O</b> 43165	NI, OZ	(4) 60W (C)	15W x 27H	101	34	72	Add. chain 2996 NI, OZ.

Measurements shown in inches.

# Indoor Lighting

## Pendants

Satin Etched White Glass



**A** 43153 AP, MIZ

Satin Etched White Glass with Satin Etched Diffuser



**B** 42561 BPT, OZ

NI: White Scavo Glass  
OZ: White Scavo Glass with Light Umber Tint



**C** 43227 NI, OZ

Etched Seeded Glass



**D** 3502 NI, TZ

NI: Alabaster Swirl Glass  
OZ: Umber Etched Glass



**E** 3277 NI, OZ

Satin Etched Glass



**F** 3348 NI

Satin Etched Glass



**G** 42881 NI, OZ

Etched Seeded Glass



**H** 2702 NI, TZ

Satin Etched Glass



**I** 3349 NI

Satin Etched Glass



**J** 42882 NI, OZ

ITEM #	FINISH	LIGHT SOURCE	DIMENSIONS	OVRL. H	EXTRA WIRE	CHAIN/STEM	NOTES
<b>A</b>	43153 AP, MIZ	(3) 100W (M)	18W x 21.75H	96	23	72	Add. chain 2996 AP, MIZ. Shades: AP: White Organza with gray, or MIZ: Light Umber with brown trim
<b>B</b>	42561 BPT, OZ	(3) 100W (M)	24.5W x 24.5H	63	92	36	Add. chain 2996 BPT, OZ. Add. stem 2999 BPT, OZ. Sloped ceiling kit incl.
<b>C</b>	43227 NI, OZ	(3) 100W (M)	18W x 21.5H	96	24	72	Add. chain 2996 NI, OZ.
<b>D</b>	3502 NI, TZ	(3) 100W (M)	17.75W x 19H	93	21	72	Add. chain 2996 NI, TZ.
<b>E</b>	3277 NI, OZ	(3) 100W (M)	17.5W x 21.5H	96	26	72	Add. chain 2996 NI, OZ.
<b>F</b>	3348 NI	(1) 100W (M)	12W x 15.5H	90	32	72	Add. chain 2996 NI.
<b>G</b>	42881 NI, OZ	(1) 150W (M)	16W x 9.5H	84	37	72	Add. chain 2996 NI, OZ.
<b>H</b>	2702 NI, TZ	(1) 150W (M)	17.5W x 8.5H	83	36	72	Add. chain 2996 NI, TZ.
<b>I</b>	3349 NI	(1) 150W (M)	15W x 15H	89	32	72	Add. chain 2996 NI. G Type bulb recommended.
<b>J</b>	42882 NI, OZ	(1) 150W (M)	13W x 21.25H	96	30	72	Add. chain 2996 NI, OZ.

= ADA Compliant 
 = DAMP 
 = WET 
 = Dark Sky Compliant 
 = LED Integrated 
 = Lamp Included 
 = CFL Lamp Included 
 = LED Bulb Included





LED Downlight 43846 WHLED30, Shailene™ Wall Sconce 45572 NI, Shailene™ Chandelier 43670 NI | Pages 15, 74

Crosby

 <p><b>43999 CH, NI, OZ</b> Chandelier</p>	 <p><b>43997 CH, NI, OZ</b> Chandelier</p>	 <p><b>43995 CH, NI, OZ</b> Linear Chandelier</p>	<p>Page 67</p>  <p><b>43998 CH, NI, OZ</b> Pendant</p>	<p>Page 63</p>  <p><b>43996 CH, NI, OZ</b> Mini Pendant</p>
<p>Page 38</p>  <p><b>45495 CH, NI, OZ</b> Wall Sconce</p>	<p>Page 48</p>  <p><b>45496 CH, NI, OZ</b> 2-Light Bath</p>	<p>Page 48</p>  <p><b>45497 CH, NI, OZ</b> 3-Light Bath</p>	<p>Page 48</p>  <p><b>45498 CH, NI, OZ</b> 4-Light Bath</p>	

See product detail pages for energy options.

# Eileen™

 Energy Star Options Available

 <p><b>1896 AP, NI, OZS</b> Chandelier</p>	 <p><b>1894 NI, OZS</b> Chandelier</p>	<p>Page 24</p>  <p><b>3797 CH, NI, OZS</b> Semi Flush</p>	<p>Page 25</p>  <p><b>8043 NI, OZS</b> Flush Mount</p>	<p>Page 59</p>  <p><b>3497 NI, OZS</b> Mini Pendant</p>
<p>Page 60</p>  <p><b>3299 NI, OZS</b> Inverted Pendant</p>	<p>Page 37</p>  <p><b>5096 NI, OZS</b> Wall Sconce</p>	<p>Page 44</p>  <p><b>5097 CH, NI, OZS</b> 2-Light Bath</p>	<p>Page 44</p>  <p><b>5098 CH, NI, OZS</b> 3-Light Bath</p>	<p>Page 44</p>  <p><b>5099 CH, NI, OZS</b> 4-Light Bath</p>

# Ansonia™











 <p><b>1748 NI</b> Chandelier</p>	<p>Page 26, 68</p>  <p><b>3348 NI</b> Pendant</p>	<p>Page 68</p>  <p><b>3349 NI</b> Pendant</p>	<p>Page 64</p>  <p><b>3345 NI</b> Mini Pendant</p>
<p>Page 50</p>  <p><b>5447 CH, NI, OZ</b> 2-Light Bath</p>	<p>Page 50</p>  <p><b>5448 CH, NI, OZ</b> 3-Light Bath</p>	<p>Page 50</p>  <p><b>5449 CH, NI, OZ</b> 4-Light Bath</p>	

Granby™

 <p><b>42557 BPT, OZ</b> Chandelier</p>	<p>Page 68</p>  <p><b>42561 BPT, OZ</b> Pendant</p>	<p>Page 63</p>  <p><b>42562 BPT, OZ</b> Mini Pendant</p>	<p>Page 26</p>  <p><b>42563 BPT, OZ</b> Semi Flush</p>	<p>Page 38</p>  <p><b>45358 BPT, CH, OZ</b> Wall Sconce</p>
<p>Page 49</p>  <p><b>45359 BPT, CH, OZ</b> 2-Light Bath</p>	<p>Page 49</p>  <p><b>45360 BPT, CH, OZ</b> 3-Light Bath</p>		<p>Page 49</p>  <p><b>45361 BPT, CH, OZ</b> 4-Light Bath</p>	

Langford™

 Energy Star Options Available

 <p><b>1788 NI, OZ</b> Mini Chandelier</p>	 <p><b>1783 NI, OZ</b> Chandelier</p>	 <p><b>1781 NI, OZ</b> Chandelier/Dinette</p>	<p>Page 60</p>  <p><b>3384 NI, OZ</b> Inverted Pendant</p>	<p>Page 59</p>  <p><b>3482 NI, OZ</b> Mini Pendant</p>	<p>Page 24</p>  <p><b>3681 NI, OZ</b> Inverted Pendant</p>
<p>Page 25</p>  <p><b>3694 NI, OZ</b> Semi Flush</p>	<p>Page 37</p>  <p><b>5388 NI, OZ</b> Wall Sconce</p>	<p>Page 44</p>  <p><b>5389 NI, OZ</b> 2-Light Bath</p>	<p>Page 44</p>  <p><b>5390 NI, OZ</b> 3-Light Bath</p>	<p>Page 44</p>  <p><b>5391 NI, OZ</b> 4-Light Bath</p>	

See product detail pages for energy options.



## Niles



**43994 AP, OZ**  
Chandelier

Page 50



**43993 AP, OZ**  
Chandelier

Page 50



**43992 AP, OZ**  
Chandelier

Page 50



Page 38

**45590 AP, OZ**  
Wall Sconce



**45591 AP, OZ**  
2-Light Bath



**45592 AP, OZ**  
3-Light Bath



**45593 AP, OZ**  
4-Light Bath

## Harmony



**44064 NI, OZ**  
Chandelier

Page 38



**44063 NI, OZ**  
Chandelier

Page 51



Page 28

**44066 NI, OZ**  
Semi Flush

Page 51



Page 63

**44065 NI, OZ**  
Mini Pendant

Page 51



**45892 NI, OZ**  
Wall Sconce



**45893 NI, OZ**  
2-Light Bath



**45894 NI, OZ**  
3-Light Bath



**45895 NI, OZ**  
4-Light Bath

**Keiran™**

 Energy Star Options Available

 <p><b>43504 NI, OZ</b> Chandelier</p>	 <p><b>43503 NI, OZ</b> Chandelier/Dinette</p>	<p>Page 24</p>  <p><b>43512 NI, OZ</b> Semi Flush</p>	<p>Page 59</p>  <p><b>43511 NI, OZ</b> Mini Pendant</p>
<p>Page 37</p>  <p><b>45504 NI, OZ</b> Wall Sconce</p>	<p>Page 45</p>  <p><b>45512 NI, OZ</b> 2-Light Bath</p>	<p>Page 45</p>  <p><b>45513 NI, OZ</b> 3-Light Bath</p>	<p>Page 45</p>  <p><b>45514 NI, OZ</b> 4-Light Bath</p>

**Shailene™**

 <p><b>43671 NI, OZ</b> Chandelier</p>	 <p><b>43670 NI, OZ</b> Chandelier</p>	<p>Page 64</p>  <p><b>43674 NI, OZ</b> Mini Pendant</p>	<p>Page 27</p>  <p><b>43675 NI, OZ</b> Semi Flush</p>
<p>Page 27</p>  <p><b>43691 NI, OZ</b> Semi Flush</p>	<p>Page 27</p>  <p><b>43692 NI, OZ</b> Semi Flush</p>	<p>Page 27</p>  <p><b>43693 NI, OZ</b> Semi Flush</p>	<p>Page 38</p>  <p><b>45572 CH, NI, OZ</b> Wall Sconce</p>
<p>Page 49</p>  <p><b>45573 CH, NI, OZ</b> 2-Light Bath</p>	<p>Page 49</p>  <p><b>45574 CH, NI, OZ</b> 3-Light Bath</p>	<p>Page 49</p>  <p><b>45575 CH, NI, OZ</b> 4-Light Bath</p>	

# Armida™

 Energy Star Options Available

 <p><b>43074 NI, OZ</b> Chandelier</p>	 <p><b>43073 NI, OZ</b> Mini Chandelier</p>	<p>Page 60</p>  <p><b>43076 NI, OZ</b> Foyer Pendant</p>	<p>Page 59</p>  <p><b>43077 NI, OZ</b> Mini Pendant</p>	<p>Page 25</p>  <p><b>3694 NIW, OZW</b> Semi Flush</p>
<p>Page 75</p>  <p><b>45374 CH, NI, OZ</b> Wall Sconce</p>	<p>Page 45</p>  <p><b>45375 CH, NI, OZ</b> 2-Light Bath</p>	<p>Page 45</p>  <p><b>45376 CH, NI, OZ</b> 3-Light Bath</p>	<p>Page 45</p>  <p><b>45377 CH, NI, OZ</b> 4-Light Bath</p>	

# Joelson™

 Energy Star Options Available

 <p><b>43923 NI, OZ</b> Chandelier</p>	 <p><b>43922 NI, OZ</b> Chandelier</p>	<p>Page 25</p>  <p><b>43925 NI, OZ</b> Pendant</p>	<p>Page 25</p>  <p><b>43926 NI, OZ</b> Semi Flush</p>	<p>Page 58</p>  <p><b>43927 NI, OZ</b> Mini Pendant</p>
<p>Page 37</p>  <p><b>45921 NI, OZ</b> Wall Sconce</p>	<p>Page 46</p>  <p><b>45922 NI, OZ</b> 2-Light Bath</p>	<p>Page 46</p>  <p><b>45923 NI, OZ</b> 3-Light Bath</p>	<p>Page 46</p>  <p><b>45924 NI, OZ</b> 4-Light Bath</p>	

See product detail pages for energy options.

Aubrey™

Energy Star Options Available

 <p><b>43665 NI, OZ</b> Chandelier</p>	 <p><b>43664 NI, OZ</b> Chandelier</p>	<p>Page 58</p>  <p><b>43668 NI, OZ</b> Mini Pendant</p>	<p>Page 25</p>  <p><b>43669 NI, OZ</b> Semi Flush</p>
<p>Page 37</p>  <p><b>45568 NI, OZ</b> Wall Sconce</p>	<p>Page 45</p>  <p><b>45569 NI, OZ</b> 2-Light Bath</p>	<p>Page 45</p>  <p><b>45570 NI, OZ</b> 3-Light Bath</p>	<p>Page 45</p>  <p><b>45571 NI, OZ</b> 4-Light Bath</p>

Tao

 <p><b>44051 NI, OZ</b> Chandelier</p>	 <p><b>44050 NI, OZ</b> Chandelier</p>	 <p><b>44054 NI, OZ</b> Pendant</p>	<p>Page 64</p>  <p><b>44053 NI, OZ</b> Mini Pendant</p>
<p>Page 38</p>  <p><b>45888 NI, OZ</b> Wall Sconce</p>	<p>Page 48</p>  <p><b>45889 NI, OZ</b> 2-Light Bath</p>	<p>Page 48</p>  <p><b>45890 NI, OZ</b> 3-Light Bath</p>	<p>Page 48</p>  <p><b>45891 NI, OZ</b> 4-Light Bath</p>

See product detail pages for energy options.

## Winslow

 <p><b>44030 NI, OZ</b> Chandelier</p>	 <p><b>44029 NI, OZ</b> Chandelier</p>	<p>Page 28</p>  <p><b>44033 NI, OZ</b> Semi Flush</p>	<p>Page 63</p>  <p><b>44032 NI, OZ</b> Mini Pendant</p>
<p>Page 38</p>  <p><b>45910 NI, OZ</b> Wall Sconce</p>	<p>Page 50</p>  <p><b>45885 NI, OZ</b> 2-Light Bath</p>	<p>Page 50</p>  <p><b>45886 NI, OZ</b> 3-Light Bath</p>	<p>Page 50</p>  <p><b>45887 NI, OZ</b> 4-Light Bath</p>

## Jolie

 Energy Star Options Available













 <p><b>43638 NI, OZ</b> Chandelier</p>	 <p><b>43637 NI, OZ</b> Chandelier</p>	<p>Page 25</p>  <p><b>43641 NI, OZ</b> Semi Flush</p>	<p>Page 59</p>  <p><b>43640 NI, OZ</b> Mini Pendant</p>
<p>Page 37</p>  <p><b>45637 CH, NI, OZ</b> Wall Sconce</p>	<p>Page 46</p>  <p><b>45638 CH, NI, OZ</b> 2-Light Bath</p>	<p>Page 46</p>  <p><b>45639 CH, NI, OZ</b> 3-Light Bath</p>	<p>Page 46</p>  <p><b>45640 CH, NI, OZ</b> 4-Light Bath</p>

See product detail pages for energy options.

Nicholson™

 <p><b>42884 NI, OZ</b> Chandelier</p>	 <p><b>42883 NI, OZ</b> Chandelier</p>	<p>Page 26</p>  <p><b>42879 NI, OZ</b> Semi Flush</p>	<p>Page 64</p>  <p><b>42880 NI, OZ</b> Mini Pendant</p>	<p>Page 68</p>  <p><b>42882 NI, OZ</b> Foyer Pendant</p>
<p>Page 68</p>  <p><b>42881 NI, OZ</b> Pendant</p>	<p>Page 39</p>  <p><b>45881 NI, OZ</b> Wall Sconce</p>	<p>Page 52</p>  <p><b>45882 NI, OZ</b> 2-Light Bath</p>	<p>Page 52</p>  <p><b>45883 NI, OZ</b> 3-Light Bath</p>	<p>Page 52</p>  <p><b>45884 NI, OZ</b> 4-Light Bath</p>

Dover™

 <p><b>2021 NI, TZ</b> Chandelier</p>	 <p><b>2020 AB, NI, TZ</b> Chandelier</p>	 <p><b>2019 NI, TZ</b> Chandelier</p>	<p>Page 68</p>  <p><b>3502 NI, TZ</b> Pendant</p>
<p>Page 64</p>  <p><b>2771 NI, TZ</b> Mini Pendant</p>	<p>Page 26</p>  <p><b>3623 NI, TZ</b> Semi Flush</p>	<p>Page 28</p>  <p><b>8064 NI, TZ</b> Flush Mount</p>	<p>Page 28</p>  <p><b>8065 NI, TZ</b> Flush Mount</p>
<p>Page 39</p>  <p><b>6719 NI, TZ</b> Wall Sconce</p>	<p>Page 52</p>  <p><b>6322 NI, TZ</b> 2-Light Bath</p>	<p>Page 52</p>  <p><b>6323 NI, TZ</b> 3-Light Bath</p>	<p>Page 52</p>  <p><b>6324 NI, TZ</b> 4-Light Bath</p>

# Telford™



**2076 NI, OZ**  
Chandelier

Page 52

Page 68



**3277 NI, OZ**  
Inverted Pendant

Page 52

Page 64



**3476 NI, OZ**  
Mini Pendant

Page 39



**5991 CH, NI, OZ**  
Wall Sconce



**5992 CH, NI, OZ**  
2-Light Bath



**5993 CH, NI, OZ**  
3-Light Bath



**5994 CH, NI, OZ**  
4-Light Bath

Page 52

# Wynberg™



**2093 NI, OZ**  
Chandelier

Page 39



**3293 NI, OZ**  
Chandelier/Dinette

Page 64



**2693 NI, OZ**  
Mini Pendant

Page 25



**3694 NI, OZ**  
Pendant



**5294 NI, OZ**  
Wall Sconce

See product detail pages for energy options.

Tallie™

Page 67



**43139 AP, MIZ**  
Pendant

Page 63



**43152 AP, MIZ**  
Mini Pendant

Page 68



**43153 AP, MIZ**  
Pendant

Page 27



**43154 AP, MIZ**  
Semi Flush

Page 27



**43194 AP, MIZ**  
Semi Flush

Page 39



**45449 AP, MIZ**  
Wall Sconce

Page 51



**45450 AP, MIZ**  
2-Light Bath

Page 51



**45451 AP, MIZ**  
3-Light Bath

Page 51



**45452 AP, MIZ**  
4-Light Bath



# Monroe™

 Energy Star Options Available



**43156 NI, OZ**  
Chandelier

Page 60



**43158 NI, OZ**  
Chandelier

Page 24



**43155 NI, OZ**  
Chandelier/Dinette

Page 59



Page 60

**43164 NI, OZ**  
Inverted Pendant

Page 37



**43163 NI, OZ**  
Inverted Pendant

Page 46



**43169 NI, OZ**  
Semi Flush

Page 46



**43162 NI, OZ**  
Mini Pendant

Page 59



**43170 NI, OZ**  
Wall Sconce



**45054 NI, OZ**  
2-Light Bath

Page 46



**45055 NI, OZ**  
3-Light Bath

Page 46



**45056 NI, OZ**  
4-Light Bath

Page 46

# Versailles



**43392 AP, OZ**  
Chandelier

Page 51



**43391 AP, OZ**  
Chandelier

Page 51



Page 64

**43394 AP, OZ**  
Mini Pendant



Page 39

**45595 AP, OZ**  
Wall Sconce



**45596 AP, OZ**  
2-Light Bath

Page 51



**45597 AP, OZ**  
3-Light Bath

Page 51



**45598 AP, OZ**  
4-Light Bath

Page 51

Tanglewood™

 Energy Star Options Available

 <p><b>42906 NI, OZ</b> Chandelier</p>	 <p><b>42905 NI, OZ</b> Chandelier</p>	<p>Page 60</p>  <p><b>42902 NI, OZ</b> Pendant</p>	 <p><b>42903 NI, OZ</b> Pendant</p>	<p>Page 59</p>  <p><b>42901 NI, OZ</b> Mini Pendant</p>
<p>Page 24</p>  <p><b>42900 NI, OZ</b> Flush Mount</p>	<p>Page 37</p>  <p><b>45901 NI, OZ</b> Wall Sconce</p>	<p>Page 47</p>  <p><b>45902 NI, OZ</b> 2-Light Bath</p>	<p>Page 47</p>  <p><b>45903 NI, OZ</b> 3-Light Bath</p>	<p>Page 47</p>  <p><b>45904 NI, OZ</b> 4-Light Bath</p>

Camerena™

 <p><b>43225 NI, OZ</b> Chandelier</p>	 <p><b>43224 NI, OZ</b> Chandelier</p>	<p>Page 68</p>  <p><b>43223 NI, OZ</b> Pendant</p>	 <p><b>43227 NI, OZ</b> Pendant</p>	<p>Page 64</p>  <p><b>43230 NI, OZ</b> Mini Pendant</p>
<p>Page 26</p>  <p><b>43232 NI, OZ</b> Flush Mount</p>	<p>Page 39</p>  <p><b>45421 NI, OZ</b> Wall Sconce</p>	<p>Page 53</p>  <p><b>45422 NI, OZ</b> 2-Light Bath</p>	<p>Page 53</p>  <p><b>45423 NI, OZ</b> 3-Light Bath</p>	<p>Page 53</p>  <p><b>45424 NI, OZ</b> 4-Light Bath</p>

See product detail pages for energy options.

# Bixler™

 Energy Star Options Available



**43938 NI, OZ**  
Chandelier

Page 37



**43937 NI, OZ**  
Chandelier

Page 47

Page 67



**43940 NI, OZ**  
Foyer Pendant

Page 47

Page 59



**43941 NI, OZ**  
Mini Pendant

Page 47



**45938 NI, OZ**  
Wall Sconce



**45939 NI, OZ**  
2-Light Bath



**45940 NI, OZ**  
3-Light Bath



**45941 NI, OZ**  
4-Light Bath

## New in 2019

# Marimount



**44043 AUB**  
Linear Chandelier



**44044 AUB**  
Pendant



**43595 BK**  
Oval Chandelier



**43594 BK**  
Pendant



**44045 AUB**  
Mini Pendant



**43596 BK**  
Foyer Pendant



**43597 BK**  
Mini Pendant

# Piston™

## Cabinet Lighting



# Cabinet Lighting

Enhance task-driven activity in offices, break rooms, kitchens, and beyond. Kichler Lighting Under Cabinet fixtures combine the light source with the driver to allow for direct wiring into the wall. The fixtures can also link together, directly one to the next [max. 3], or interconnect cables, to create a system of lights along the length of cabinetry. Many models can install either in the front or back of the cabinet to create a desired end result.

To learn more about our FREE layout design and technical support services visit [Kichler.com/APS](http://Kichler.com/APS)

**LED** page 86

**Fluorescent** page 89



## Quality and value lighting for any application.

A low-profile design, durable finish and gently diffused light output make these LED fixtures a true value—ideal for a variety of applications, from single-family homes to multi-unit structures.



Shown: 4U27K12WHT

		Finish, Color Temperature and Size						
Available Finishes	Textured Bronze (BZT), Textured White (WHT)				Available Finishes			
Color Temperature	2700K - Warm White		3000K - Pure White					
Size	8"	12"	22"	30"	8"	12"	22"	30"
	<b>4U27K08</b> BZT, WHT 8" L x 4.5" W x 1.1" H 175 delivered lumens 4 Watts	<b>4U27K12</b> BZT, WHT 12" L x 4.5" W x 1.1" H 250 delivered lumens 6 Watts	<b>4U27K22</b> BZT, WHT 22" L x 4.5" W x 1.1" H 485 delivered lumens 10 Watts	<b>4U27K30</b> BZT, WHT 30" L x 4.5" W x 1.1" H 650 delivered lumens 14 Watts	<b>4U30K08</b> BZT, WHT 8" L x 4.5" W x 1.1" H 200 delivered lumens 4 Watts	<b>4U30K12</b> BZT, WHT 12" L x 4.5" W x 1.1" H 285 delivered lumens 6 Watts	<b>4U30K22</b> BZT, WHT 22" L x 4.5" W x 1.1" H 560 delivered lumens 10 Watts	<b>4U30K30</b> BZT, WHT 30" L x 4.5" W x 1.1" H 750 delivered lumens 14 Watts
<b>Benefits</b>	<b>Product Benefits</b> <ul style="list-style-type: none"> <li>• Quality, diffused light output</li> <li>• 90 CRI keeps furnishings true-to-color</li> <li>• Replaceable driver extends the life of the fixture</li> <li>• Energy efficient, LED light source</li> <li>• FCC compliant and can be used to comply with 2016 Title 24, Part 6 High efficacy LED light source requirements</li> <li>• Durable powder coat finish</li> <li>• Dimmable with standard wall dimmer</li> </ul>				<b>Installation Benefits</b> <ul style="list-style-type: none"> <li>• Captive screws for quick installation</li> <li>• Direct wire and linkable</li> <li>• Knockouts in sides and in back of fixture</li> <li>• 1" profile, 4.5" depth</li> <li>• BX connector 10589 included with fixture</li> </ul>			
<b>Warranty</b>	3-year residential warranty. 1-year commercial warranty. See <a href="http://Kichler.com/warranty">Kichler.com/warranty</a> for complete details.							
<b>Accessories</b>	See page 88 for available cables, connectors and cords. For recommended dimmers visit <a href="http://Kichler.com/dimming">Kichler.com/dimming</a> .							





# 6U Series – LED

## Two-in-one selectable color temperature to customize any installation.

Take the guesswork out of choosing the right lighting: the 6U Series LED from Kichler Lighting 6U fixtures allow you to choose a warm or pure white light with the flip of a switch. You get variety and customization that can change easily to enhance your decor in different ways throughout the day. It's a beautiful end effect that always works—with whatever countertop, paint or cabinet colors you have in your workspace.

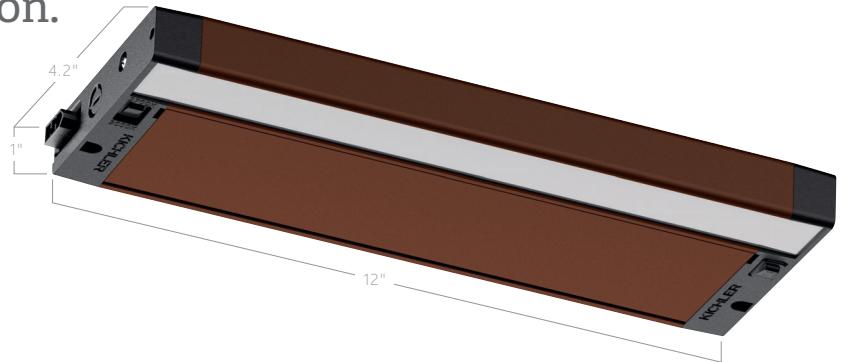







Shown: 6UCSK12BZT

Finish, Color Temperature and Size										
<b>Available Finishes</b>	<b>Textured Bronze (BZT), Textured Nickel (NIT), Textured White (WHT)</b>									
<b>Color Temperature</b>	<b>2700K - Warm White and 3000K - Pure White</b>									
<b>Size</b>	<table border="1"> <tr> <td><b>8"</b></td> <td><b>6UCSK08</b> BZT, NIT, WHT 8" L x 4.2" W x 1" H 270 delivered lumens 7 Watts</td> </tr> <tr> <td><b>12"</b></td> <td><b>6UCSK12</b> BZT, NIT, WHT 12" L x 4.2" W x 1" H 400 delivered lumens 9 Watts</td> </tr> <tr> <td><b>22"</b></td> <td><b>6UCSK22</b> BZT, NIT, WHT 22" L x 4.2" W x 1" H 735 delivered lumens 16 Watts</td> </tr> <tr> <td><b>30"</b></td> <td><b>6UCSK30</b> BZT, NIT, WHT 30" L x 4.2" W x 1" H 1000 delivered lumens 19 Watts</td> </tr> </table>	<b>8"</b>	<b>6UCSK08</b> BZT, NIT, WHT 8" L x 4.2" W x 1" H 270 delivered lumens 7 Watts	<b>12"</b>	<b>6UCSK12</b> BZT, NIT, WHT 12" L x 4.2" W x 1" H 400 delivered lumens 9 Watts	<b>22"</b>	<b>6UCSK22</b> BZT, NIT, WHT 22" L x 4.2" W x 1" H 735 delivered lumens 16 Watts	<b>30"</b>	<b>6UCSK30</b> BZT, NIT, WHT 30" L x 4.2" W x 1" H 1000 delivered lumens 19 Watts	<p><b>BZT</b> <b>NIT</b> <b>WHT</b></p>
<b>8"</b>	<b>6UCSK08</b> BZT, NIT, WHT 8" L x 4.2" W x 1" H 270 delivered lumens 7 Watts									
<b>12"</b>	<b>6UCSK12</b> BZT, NIT, WHT 12" L x 4.2" W x 1" H 400 delivered lumens 9 Watts									
<b>22"</b>	<b>6UCSK22</b> BZT, NIT, WHT 22" L x 4.2" W x 1" H 735 delivered lumens 16 Watts									
<b>30"</b>	<b>6UCSK30</b> BZT, NIT, WHT 30" L x 4.2" W x 1" H 1000 delivered lumens 19 Watts									
<b>Benefits</b>	<p><b>Product Benefits</b></p> <ul style="list-style-type: none"> <li>• Switch fixture from 2700K to 3000K for homeowner customization</li> <li>• Quality, diffused light output eliminates hot spots on countertop</li> <li>• 90 CRI keeps furnishings true-to-color</li> <li>• Replaceable driver extends the life of the fixture</li> <li>• Energy efficient, LED light source</li> <li>• FCC compliant and can be used to comply with 2016 Title 24, Part 6 High efficacy LED light source requirements</li> <li>• Dimmable with standard wall dimmer</li> </ul>	<p><b>Installation Benefits</b></p> <ul style="list-style-type: none"> <li>• Smaller profile driver creates more access to wiring, helping contractors install jobs faster</li> <li>• Cable connectors and captive screws ensure installation ease</li> <li>• Direct wire and linkable</li> <li>• Knockouts on end caps for easy connectivity</li> <li>• 1" profile, 4.2" depth</li> <li>• BX connector 10589 included with fixture</li> </ul>								
<b>Warranty</b>	5-year residential warranty. 3-year commercial warranty. See <a href="http://Kichler.com/warranty">Kichler.com/warranty</a> for complete details.									
<b>Accessories</b>	See page 88 for available cables, connectors and cords. For recommended dimmers visit <a href="http://Kichler.com/dimming">Kichler.com/dimming</a> .									

## Link with ease.

Kichler Lighting Accessories are available in an array of durable cables and connectors to create an interconnected, evenly powered under cabinet system design.

Under Cabinet Accessories (optional)			
	Accessories	Compatible Fixtures	
Cables & Connectors	<b>10571</b> BK, WH 9" interconnect cable	<b>6U &amp; 4U LED</b>	
	<b>10572</b> BK, WH 14" interconnect cable	<b>6U &amp; 4U LED</b>	
	<b>10573</b> BK, WH 21" interconnect cable	<b>6U &amp; 4U LED</b>	
	<b>10570</b> BK, WH Wire module 7.75" L x 2.625" W x 1" H	<b>6U &amp; 4U LED</b>	
	<b>10588</b> SI Duplex BX cable connector	<b>6U, 4U LED &amp; Fluorescent</b>	
	<b>10589</b> SI (included with fixture) Connector for NM & BX cable	<b>6U, 4U LED &amp; Fluorescent</b>	
	<b>6UCORD</b> BK, WH 60" under cabinet interconnect prong cord	<b>6U &amp; 4U LED</b>	

## Installation

### Options that add versatility.

Kichler 4U and 6U LED under cabinet fixtures can be installed two different ways: either direct wired for installation closer to the wall, or linked together using accessories for installation near the front face of cabinets.



**Back of Cabinet Installation – Direct wire connect.**

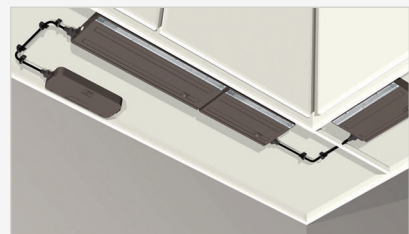

**Front Mount – Use wire module and interconnect cable.**





# Fluorescent – 120V

## Convenience and value come together.

Kichler Lighting direct wire fluorescent fixtures combine the energy efficiency of fluorescent bulbs with the convenience of traditional incandescent fixtures.



Shown: 10041WH

Finish, Color Temperature and Size			
Available Finish	White (WH)		Available Finish
Color Temperature	2700K equivalent		
Size	12.25"	<b>10041 WH</b> 12.25" L x 3.5" W x 1" H T5 Fluorescent lamp included 8 Watts maximum <b>Direct Wire Only</b>	
	21.5"	<b>10042 WH</b> 21.5" L x 3.5" W x 1" H T5 Fluorescent lamp included 13 Watts maximum <b>Direct Wire Only</b>	
	34.5"	<b>10043 WH</b> 34.5" L x 3.5" W x 1" H T5 Fluorescent lamp included 21 Watts maximum <b>Direct Wire Only</b>	
	46.5"	<b>10044 WH</b> 46.5" L x 3.5" W x 1" H T5 Fluorescent lamp included 28 Watts maximum <b>Direct Wire Only</b>	
			<b>Installation</b> <b>Back of Cabinet Installation – Direct wire connect.</b>
Benefits	<b>Product Benefits</b> <ul style="list-style-type: none"> <li>• Combines the energy efficiency of Fluorescent lighting with the convenience and popularity of incandescent fixtures</li> <li>• Fully replaceable bulbs</li> </ul>	<b>Installation Benefits</b> <ul style="list-style-type: none"> <li>• Hinged assembly</li> <li>• Multiple knockouts for installation ease</li> <li>• NM &amp; BX single cable connector included</li> <li>• 1" profile, 3.5" depth</li> </ul>	
Warranty	3-year residential warranty. 1-year commercial warranty. See <a href="http://Kichler.com/warranty">Kichler.com/warranty</a> for complete details.		
Accessories	<b>Bulbs: 10081 FST, 10082 FST, 10083 FST, 10084 FST Cable Connectors: 10588, 10589.</b>		

## LED Tape & Accent Lighting



# LED Tape & Accent

**Dry Tape - 12V, 24V** page 92

**Damp and RGB Tape - 24V** page 94

**Accent Discs - 12V, 24V** page 98

**Hard Strips - 24V** page 99

**Power Supplies** page 101

**Accessories and Wire** page 104

Versatile LED Tape and Accent lighting brings illumination to small or unique spaces throughout a project. While LED tape is ideal for lining a cove ceiling or shelving, LED Accent discs can illuminate architectural niches. Low voltage fixtures can also be combined in the same design. So when working within the same voltage (24-to-24V, 12-to-12V), you can mix and match LED Accent Discs, LED Tape and LED Hard Strips on the same power supply—saving time and materials on the job.

To learn more about our FREE layout design and technical support services visit [Kichler.com/APS](http://Kichler.com/APS)



# LED Tape & Accent Lighting

# Dry – 4T Series, 12V LED

A low voltage design and the ability to cut to 2" increments makes the 4T Series ideal for short runs and smaller spaces, like lining shelves or cabinets.



Shown: 4T1100H30WH

Finish, Color Temperature, Lumens and Size						
Location Use	Dry Locations Only					
Available Finish	White (WH)					
Color Temperature	2700K - Warm White		3000K - Pure White		5000K - Bright White	
Standard Output	16'	4T116S27 WH 24 Watts	16'	4T116S30 WH 24 Watts	16'	4T116S50 WH 24 Watts
	100'	4T1100S27 WH	100'	4T1100S30 WH	100'	4T1100S50 WH
High Output	16'	4T116H27 WH 48 Watts	16'	4T116H30 WH 48 Watts	16'	4T116H50 WH 48 Watts
	100'	4T1100H27 WH	100'	4T1100H30 WH	100'	4T1100H50 WH
Supply Wire	Tape light rolls come with a 2' supply wire soldered to the beginning and end of each roll.					
Warranty	3-year residential warranty. 1-year commercial warranty. See <a href="http://Kichler.com/warranty">Kichler.com/warranty</a> for complete details.					
Additional Info	For recommended dimmers visit <a href="http://Kichler.com/dimming">Kichler.com/dimming</a> .					

## Build your lighting system

The ability to build a lighting system is one of the many things that makes low-voltage LED tape and accent lighting so versatile. With the right components, you can install lighting just about anywhere your supply wire can take you, including coves, toe kicks, shelving or drawers. To build your system, you'll need:

**Product + Power Supply + Supply Wire, Leads and Interconnects + Accessories = Light**

**1**  
Select your Product



Page 92

+

**2**  
Select your Power Supply



Page 101

+

**3**  
Select Supply Leads and/or Interconnects



Pages 106, 107

+

**4**  
Select Wire



Page 104

+

**5**  
Utilize Accessories



Page 110



# Dry – 6T Series, 24V LED

Choose your color temperature, your ideal wattage and more. The 6T Series brings a lengthy run of illumination to a variety of dry locations and features 3M™ adhesive backing for secure placement, every time.



Shown: 6T120S30WH

		Finish, Color Temperature, Lumens and Size							
Location Use		Dry Locations Only							
Available Finishes		Black (BK), White (WH)							
Color Temperature		2400K - Amber White		2700K - Warm White		3000K - Pure White		5000K - Bright White	
<b>Standard Output</b> • 32' max. linear run length • 120–145 delivered lumens per foot • 1.5W per foot, 90 CRI • Cuttable every 4"			10'	6T110S27 BK, WH 15 Watts	10'	6T110S30 BK, WH 15 Watts			
	16'	6T116S24 BK, WH 24 Watts	16'	6T116S27 BK, WH 24 Watts	16'	6T116S30 BK, WH 24 Watts	16'	6T116S50 BK, WH 24 Watts	
			100'	6T1100S27 BK, WH	100'	6T1100S30 BK, WH	100'	6T1100S50 BK, WH	
<b>High Output</b> • 20' max. linear run length • 215–270 delivered lumens per foot • 3W per foot, 90 CRI • Cuttable every 4"			10'	6T110H27 BK, WH 30 Watts	10'	6T110H30 BK, WH 30 Watts			
	20'	6T120H24 BK, WH 60 Watts	20'	6T120H27 BK, WH 60 Watts	20'	6T120H30 BK, WH 60 Watts	20'	6T120H50 BK, WH 60 Watts	
			100'	6T1100H27 BK, WH	100'	6T1100H30 BK, WH	100'	6T1100H50 BK, WH	
<b>Ultra-High Output*</b> • 10' max. linear run length • 490–590 delivered lumens per foot • 7.2W per foot, 90 CRI • Cuttable every 2"			10'	6T110UH27 BK, WH 72 Watts	10'	6T110UH30 BK, WH 72 Watts	10'	6T110UH50 BK, WH 72 Watts	
	* Ultra-High output tape requires soldered connections; doesn't work with tape light supply leads or connectors. Cannot be used with 12330 plastic track.								
<b>Supply Wire</b>	Tape light rolls come with a 2' supply wire soldered to the beginning and end of each roll.								
<b>Warranty</b>	5-year residential warranty. 3-year commercial warranty. See Kichler.com/warranty for complete details.								
<b>Additional Info</b>	For recommended dimmers visit Kichler.com/dimming.								



Follow steps 1 to 5 on the previous page to build your lighting system.

Hint: Most of our 24V compatible power supplies start with the number 6; 12V compatible power supplies start with the number 4.

Kichler Lighting damp LED tape is engineered to perform in areas with moisture exposure. Use behind a bathroom vanity, near a kitchen sink or outdoors in covered areas — such as in a gazebo or roofed patio.



Shown: 6T210H24WH

Finish, Color Temperature, Lumens and Size	
<b>Location Use</b>	Damp Locations
<b>Available Finish</b>	White (WH)
<b>Color Temperature</b>	3000K - Pure White**
<b>Standard Output</b> • 32' max. linear run length • 100 delivered lumens per foot • 1.5W per foot, 90 CRI • Cuttable every 4"	<b>10'</b> <b>6T210S24 WH</b> 15 Watts
	<b>16'</b> <b>6T216S24 WH</b> 24 Watts
<b>High Output</b> • 20' max. linear run length • 170 delivered lumens per foot • 3W per foot, 90 CRI • Cuttable every 4"	<b>10'</b> <b>6T210H24 WH</b> 30 Watts
	<b>20'</b> <b>6T220H24 WH</b> 60 Watts
<b>Supply Wire</b>	Tape light rolls come with a 2' supply lead connected to the beginning and end of each roll.
<b>Warranty</b>	5-year residential warranty. 3-year commercial warranty. See <a href="http://Kichler.com/warranty">Kichler.com/warranty</a> for complete details.
<b>Additional Info</b>	For recommended dimmers visit <a href="http://Kichler.com/dimming">Kichler.com/dimming</a> .
<b>Accessories</b>	<b>Damp Tape End Caps</b> <b>10181</b> Caps end of cut piece of damp tape 
	<b>Silicone</b> <b>10183</b> Use with 10181 damp tape end cap 

\*\* Pure White 3100K (+/-200K)

The ability to build a lighting system is one of the many things that makes low-voltage LED tape and accent lighting so versatile. With the right components, you can install lighting just about anywhere your supply wire can take you, including coves, toe kicks, shelving or drawers. To build your system, you'll need:

**Product + Power Supply + Supply Wire, Leads and Interconnects + Accessories = Light**

<b>1</b> Select your Product  Page 94	+	<b>2</b> Select your Power Supply  Page 101	+	<b>3</b> Select Supply Leads and/or Interconnects  Pages 106, 107	+	<b>4</b> Select Wire  Page 104	+	<b>5</b> Utilize Accessories  Page 110 plus those noted above
---	---	---	---	---	---	---	---	--





# Dry – 6T Series, 24V RGB LED

We combined the versatility of our 6T Series with color customization. Choose red, green or blue light – or a combination – to add a pop of color to bar areas, retail shelving, mirrors or anywhere you want an enhanced effect.



Shown: 120RGBBK

Finish, Color Temperature, Lumens and Size	
<b>Location Use</b>	Dry Locations Only
<b>Available Finishes</b>	Black (BK), White (WH)
<b>Color-Changing RGB</b>	
<b>High Output</b> • 20' max. linear run length • 4W per foot	<b>20'</b> <b>120RGB BK, WH</b> 80 Watts Must be used with 10199 BK-RGB Controller.
<b>Controller</b>	<div style="display: flex; align-items: center;"> <div style="flex: 1;"> <p><b>10199 BK-RGB Controller</b></p> <ul style="list-style-type: none"> <li>• 9A maximum</li> <li>• Must be used with RGB tape light</li> <li>• Multiple modes for unique light settings</li> <li>• Adjusts speeds and brightness</li> <li>• Connects between power supply and tape light</li> <li>• Works with DC or direct wire inputs</li> </ul> </div> <div style="flex: 1; text-align: center;">  </div> </div>
<b>Warranty</b>	5-year residential warranty. 3-year commercial warranty. See <a href="http://Kichler.com/warranty">Kichler.com/warranty</a> for complete details.
<b>Additional Info</b>	For recommended dimmers visit <a href="http://Kichler.com/dimming">Kichler.com/dimming</a> .

To build an RGB system, follow the same steps, adding in the controller between your power supply and tape light. To build your system, you'll need:

**Product + Power Supply + Controller + Supply Wire, Leads and Interconnects + Accessories = Light**

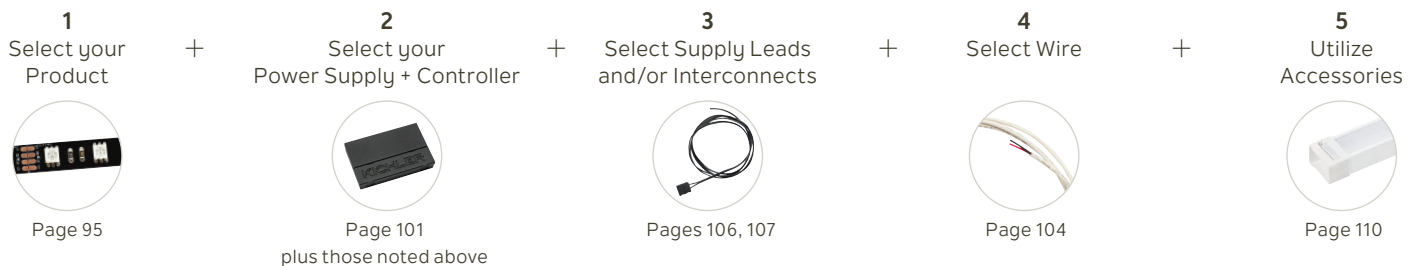

The 8T Series of Commercial Grade LED Tape Light is designed to integrate with our patent-pending connector accessory system to simplify and speed up the installation of even the most complicated tape light design configurations.



The tape features a flexible 2-layer circuit board that supports increased run lengths with less voltage drop. It then offers a push-in connector base every four inches with cut marks to either side. Eight unique connector accessories can install straight on (0-degrees) or rotated (180-degrees) – regardless of tape direction or polarity – and simply push into place.

### Commercial grade, 24/7 operation, and when paired with channels, provides countless design possibilities

- Available in Standard, High, and Ultra High output in 5 color temperatures: 2200K, 2700K, 3000K, 4000K, and 5000K
- An assortment of strips and rolls, ranging from 4" to 100'
- Compatible with 8 unique connector accessories that can decrease installation time in any design configuration
- Flexible 2-layer circuit board for extended run length: 67ft Standard, 33ft High, 10ft Ultra High
- Field-cutttable on marked cut lines on either side of the connector
- Edge-to-edge 3M™ adhesive

## 8T Series Connector Accessories (Patent Pending)

A robust pluggable tape connector accessory system

- Push in, reliable connection
- Universal polarity at the connector for ease of installation
- Provides 0-180 degree connection
- Tape-to-wire connectors allow the installer to utilize their preferred 20-22AWG wire to make custom length supply leads and jumpers
- Flexible connectors allow connections to bend around corners for new unique installation solutions
- Designed to carry the full load of Standard, High and Ultra High tape light outputs.

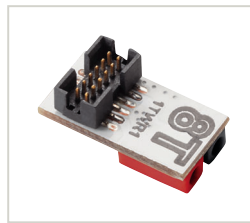

8T1TWR1WH  
Tape-to-Wire

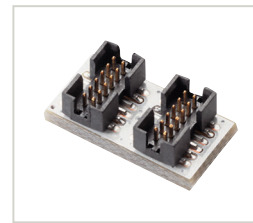

8T1TTR1WH  
Tape-to-Tape

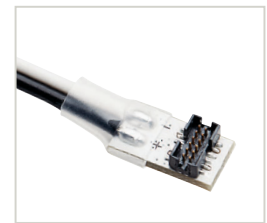

8T1TWR5WH  
Tape-to-Supply Lead  
72" - 18AWG

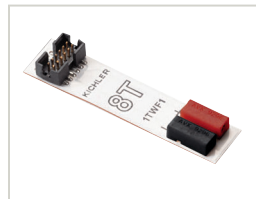

8T1TWF1WH  
Tape-to-Wire, Flex

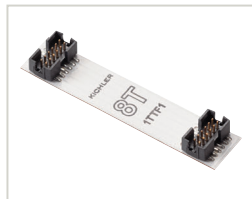

8T1TTF1WH  
Tape-to-Tape, Flex

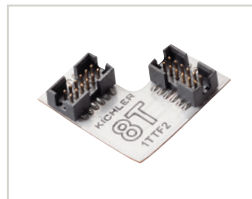

8T1TTF2WH  
90° Tape-to-Tape, Flex

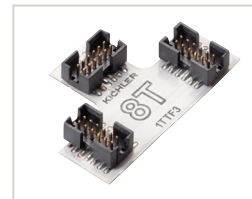

8T1TTF3WH  
3-Way Tape-to-Tape, Flex

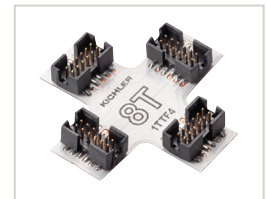

8T1TTF4WH  
4-Way Tape-to-Tape, Flex

The ability to build a lighting system is one of the many things that makes low-voltage LED tape and accent lighting so versatile. With the right components, you can install lighting just about anywhere your supply wire can take you, including TE-Series installations in commercial spaces, extensive coves in entertainment venues, and display lighting in retail locations. To build your system, you'll need:

**Product + Power Supply + Supply Wire, Leads and Interconnects + Accessories = Light**

1

Select your Product



Page 97

+

2

Select your Power Supply



Page 101

+

3

Select Supply Leads and/or Interconnects



Page 96

+

4

Select Wire



Page 104

+

5

Utilize Accessories



Pages 110  
Plus those noted above





Finish, Color Temperature, Lumens and Size										
Location Use	Dry Locations Only									
Available Finishes	White (WH)									
Color Temperature	2200K - Amber White		2700K - Warm White		3000K - Pure White		4000K - Cool White		5000K - Bright White	
<b>Standard Output</b> • 67' max. linear run length • 95-135 delivered lumens per foot • 1.5W per foot, 90 CRI • Cutable every 4" on either side of connector	4"	8T1000S22WH	4"	8T1000S27WH	4"	8T1000S30WH	4"	8T1000S40WH	4"	8T1000S50WH
	12"	8T1001S22WH	12"	8T1001S27WH	12"	8T1001S30WH	12"	8T1001S40WH	12"	8T1001S50WH
	10'	8T1010S22WH	10'	8T1010S27WH	10'	8T1010S30WH	10'	8T1010S40WH	10'	8T1010S50WH
	67'	8T1067S22WH	67'	8T1067S27WH	67'	8T1067S30WH	67'	8T1067S40WH	67'	8T1067S50WH
	100'	8T1100S22WH	100'	8T1100S27WH	100'	8T1100S30WH	100'	8T1100S40WH	100'	8T1100S50WH
<b>High Output</b> • 33' max. linear run length • 175-220 delivered lumens per foot • 3W per foot, 90 CRI • Cutable every 4" on either side of connector	4"	8T1000H22WH	4"	8T1000H27WH	4"	8T1000H30WH	4"	8T1000H40WH	4"	8T1000H50WH
	12"	8T1001H22WH	12"	8T1001H27WH	12"	8T1001H30WH	12"	8T1001H40WH	12"	8T1001H50WH
	10'	8T1010H22WH	10'	8T1010H27WH	10'	8T1010H30WH	10'	8T1010H40WH	10'	8T1010H50WH
	33'	8T1033H22WH	33'	8T1033H27WH	33'	8T1033H30WH	33'	8T1033H40WH	33'	8T1033H50WH
	100'	8T1100H22WH	100'	8T1100H27WH	100'	8T1100H30WH	100'	8T1100H40WH	100'	8T1100H50WH
<b>Ultra-High Output*</b> • 10' max. linear run length • 410-575 delivered lumens per foot • 7.2W per foot, 90 CRI • Cutable every 4" on either side of connector	10'	8T1010U22WH	10'	8T1010U27WH	10'	8T1010U30WH	10'	8T1010U40WH	10'	8T1010U50WH
	* Ultra-High cannot be used with 12330 plastic track or TE Series Extruded Channels.									
<b>Warranty</b>	5-year residential and commercial warranty. See <a href="http://Kichler.com/warranty">Kichler.com/warranty</a> for complete details.									
<b>Additional Info</b>	Compatible dimmers will vary based on selected power supply. For recommended dimmers visit <a href="http://Kichler.com/dimming">Kichler.com/dimming</a> .									

Get a stunning 190 lumens of output with just 4 Watts of power. The Kichler Lighting LED Accent Discs deliver a pure and softly diffused infusion of light inside cabinetry as a decorative accent.



Shown: 4D12V27WHT

Finish, Color Temperature, Size and Accessories					
<b>Location Use</b>	<b>Damp Locations - Enclosed Cabinets must be at least 12" D x 12" W x 12" H</b>				
<b>Available Finishes</b>	<b>Textured Black (BKT), Textured Bronze (BZT), Textured Nickel (NIT), Textured White (WHT)</b>				
<b>Color Temperature</b>	<table border="1"> <tr> <td><b>2700K - Warm White</b></td> <td><b>3000K - Pure White</b></td> </tr> </table>	<b>2700K - Warm White</b>	<b>3000K - Pure White</b>		
<b>2700K - Warm White</b>	<b>3000K - Pure White</b>				
<b>Model #</b> • 12V (4D) • 24V (6D)	<table border="1"> <tr> <td><b>2.7"</b></td> <td><b>4D12V27, 6D24V27</b> BKT, BZT, NIT, WHT 2.7" W x 0.6" H 190 lumens 4 Watt 90(+) CRI</td> <td><b>2.7"</b></td> <td><b>4D12V30, 6D24V30</b> BKT, BZT, NIT, WHT 2.7" W x 0.6" H 190 lumens 4 Watts 90(+) CRI</td> </tr> </table>	<b>2.7"</b>	<b>4D12V27, 6D24V27</b> BKT, BZT, NIT, WHT 2.7" W x 0.6" H 190 lumens 4 Watt 90(+) CRI	<b>2.7"</b>	<b>4D12V30, 6D24V30</b> BKT, BZT, NIT, WHT 2.7" W x 0.6" H 190 lumens 4 Watts 90(+) CRI
<b>2.7"</b>	<b>4D12V27, 6D24V27</b> BKT, BZT, NIT, WHT 2.7" W x 0.6" H 190 lumens 4 Watt 90(+) CRI	<b>2.7"</b>	<b>4D12V30, 6D24V30</b> BKT, BZT, NIT, WHT 2.7" W x 0.6" H 190 lumens 4 Watts 90(+) CRI		
<b>Benefits</b>	<table border="1"> <tr> <td> <p><b>Product Benefits</b></p> <ul style="list-style-type: none"> <li>• Surface mount design works well inside glass-faced kitchen cabinetry, China cabinets or curio cabinets that need light for accent or display purposes.</li> <li>• Recessed mount design is ideal for open-top shelves/cabinets.</li> <li>• Two Kelvin temperature options (2700K or 3000K) allow you to customize the light to the space.</li> <li>• Choose from four durable powder-coated finishes.</li> <li>• Premium frosted lens diffuses light cleanly and seamlessly for a "spotlight-free" effect.</li> <li>• 90(+) CRI</li> </ul> </td> <td> <p><b>Installation Benefits</b></p> <ul style="list-style-type: none"> <li>• Each puck comes with 6' of blunt-cut wire; customize your length as needed — no bunching up the wires in tight spaces.</li> <li>• Use a splice box to connect multiple pucks, or to combine with LED tape, on the same power supply (12V-to-12V, 24V-to-24V).</li> <li>• Eliminate voltage drops on long runs; use the wire that matches your needs:                             <ul style="list-style-type: none"> <li>• 24 AWG wire allows for a 40-foot run</li> <li>• 18 AWG wire allows for a 170-foot run (best used as a trunk wire to allow for longer runs)</li> </ul> </li> </ul> </td> </tr> </table>	<p><b>Product Benefits</b></p> <ul style="list-style-type: none"> <li>• Surface mount design works well inside glass-faced kitchen cabinetry, China cabinets or curio cabinets that need light for accent or display purposes.</li> <li>• Recessed mount design is ideal for open-top shelves/cabinets.</li> <li>• Two Kelvin temperature options (2700K or 3000K) allow you to customize the light to the space.</li> <li>• Choose from four durable powder-coated finishes.</li> <li>• Premium frosted lens diffuses light cleanly and seamlessly for a "spotlight-free" effect.</li> <li>• 90(+) CRI</li> </ul>	<p><b>Installation Benefits</b></p> <ul style="list-style-type: none"> <li>• Each puck comes with 6' of blunt-cut wire; customize your length as needed — no bunching up the wires in tight spaces.</li> <li>• Use a splice box to connect multiple pucks, or to combine with LED tape, on the same power supply (12V-to-12V, 24V-to-24V).</li> <li>• Eliminate voltage drops on long runs; use the wire that matches your needs:                             <ul style="list-style-type: none"> <li>• 24 AWG wire allows for a 40-foot run</li> <li>• 18 AWG wire allows for a 170-foot run (best used as a trunk wire to allow for longer runs)</li> </ul> </li> </ul>		
<p><b>Product Benefits</b></p> <ul style="list-style-type: none"> <li>• Surface mount design works well inside glass-faced kitchen cabinetry, China cabinets or curio cabinets that need light for accent or display purposes.</li> <li>• Recessed mount design is ideal for open-top shelves/cabinets.</li> <li>• Two Kelvin temperature options (2700K or 3000K) allow you to customize the light to the space.</li> <li>• Choose from four durable powder-coated finishes.</li> <li>• Premium frosted lens diffuses light cleanly and seamlessly for a "spotlight-free" effect.</li> <li>• 90(+) CRI</li> </ul>	<p><b>Installation Benefits</b></p> <ul style="list-style-type: none"> <li>• Each puck comes with 6' of blunt-cut wire; customize your length as needed — no bunching up the wires in tight spaces.</li> <li>• Use a splice box to connect multiple pucks, or to combine with LED tape, on the same power supply (12V-to-12V, 24V-to-24V).</li> <li>• Eliminate voltage drops on long runs; use the wire that matches your needs:                             <ul style="list-style-type: none"> <li>• 24 AWG wire allows for a 40-foot run</li> <li>• 18 AWG wire allows for a 170-foot run (best used as a trunk wire to allow for longer runs)</li> </ul> </li> </ul>				
<b>Warranty</b>	3-year residential warranty. 1-year commercial warranty. See <a href="http://Kichler.com/warranty">Kichler.com/warranty</a> for complete details.				



The ability to build a lighting system is one of the many things that makes low-voltage LED tape and accent lighting so versatile. With the right components, you can install lighting just about anywhere your supply wire can take you, including coves, toe kicks, shelving or drawers. To build your system, you'll need:

**Product + Power Supply + Supply Wire + Accessories = Light**





# Hard Strips, 24V LED

A rigid exterior and quick connect end-caps make Hard Strips easy to install in linear applications, such as behind a work of art. Plus, their low profile and light diffusing shell offer a versatile option for under cabinet and display lighting applications.



Finish, Color Temperature, Lumens and Size						
<b>Location Use</b>	Dry Locations Only					
<b>Available Finish</b>	Aluminum (AL) with white ends					
<b>Color Temperature</b>	2700K - Warm White		3000K - Pure White		5000K - Bright White	
<b>Standard Output</b> • 10' max. linear run length • 200–240 delivered lumens per foot • 6" unit = 2.7W • 12" unit = 4W • 90 CRI	6"	<b>6HS27K06AL</b> 24V standard dry	6"	<b>6HS30K06AL</b> 24V standard dry	6"	<b>6HS50K06AL</b> 24V standard dry
	12"	<b>6HS27K12AL</b> 24V standard dry	12"	<b>6HS30K12AL</b> 24V standard dry	12"	<b>6HS50K12AL</b> 24V standard dry
<b>Warranty</b>	5-year residential warranty. 3-year commercial warranty. See <a href="http://Kichler.com/warranty">Kichler.com/warranty</a> for complete details.					
Power Supply Leads and Interconnect Cables						
<b>Power Supply Leads</b> Connects Hard Strip to power supply. Cannot be used as an interconnect cable.	8' Hard Strip supply lead		<b>6HS1SL8 WH</b>			
	8' Hard Strip DC jack supply lead		<b>6HS1SL8DC WH</b>			
<b>Interconnect Cables</b> Used to connect two Hard Strips together.	2" Hard Strip interconnect cable		<b>6HS1IC02 WH</b>			
	6" Hard Strip interconnect cable		<b>6HS1IC06 WH</b>			
	12" Hard Strip interconnect cable		<b>6HS1IC12 WH</b>			
	36" Hard Strip interconnect cable		<b>6HS1IC36 WH</b>			
	96" Hard Strip interconnect cable		<b>6HS1IC96 WH</b>			
<b>Accessories</b> One set of each mounting clip comes included with the fixture.	<b>Hard Strip 0° Clips</b> <b>6HS0CLIPS</b> 0 degree clips		<b>Hard Strip 30° Clips</b> <b>6HS30CLIPS</b> 30 degree clips		<b>Hard Strip 45° Clips</b> <b>6HS45CLIPS</b> 45 degree clips	

To Build a Hard Strips System, you'll need:

**Product** (above) + **Power Supply** (page 101) + **Supply Leads & Interconnects** (above) + **Wire** (page 104) = **Light**

# LED Tape & Accent Lighting

# LED Driver + Dimmer

The Kichler Lighting all-in-one LED Driver + Dimmer simplifies your lighting systems installation. By integrating the driver with the dimmer switch, this one product can convert 120V AC to either 12V or 24V DC, as well as dim from 100% to 1%. Simply connect this one device to both your high voltage input and low voltage output, and install with a standard single gang box to the wall – saving time on installation.

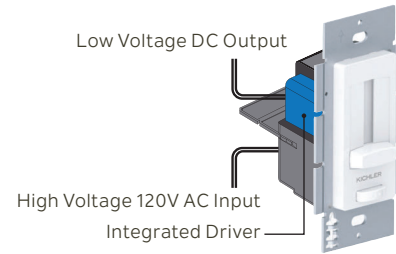



Models and Accessories									
<b>Location Use</b>	<b>Dry Locations Only*</b>								
<b>Available Finish</b>	<b>White (WH)</b>								
<b>Benefits</b>	<table border="1"> <tr> <td> <b>Product Benefits</b> <ul style="list-style-type: none"> <li>• All-in-one integrated LED Driver + Dimmer switch eliminates switch/driver compatibility issues.</li> <li>• Pre-set dimmer with on/off switch offers excellent dimming performance: 100%-1%.</li> <li>• Manages 120V AC input to control 12V or 24V constant voltage lighting systems.</li> </ul> </td> <td> <b>Installation Benefits</b> <ul style="list-style-type: none"> <li>• Eliminates the time and guesswork of finding compatible options.</li> <li>• All-in-one product saves time in ordering, tracking, and installing over multiple components.</li> <li>• Installs in a standard single-gang wall box.</li> </ul> </td> </tr> </table>	<b>Product Benefits</b> <ul style="list-style-type: none"> <li>• All-in-one integrated LED Driver + Dimmer switch eliminates switch/driver compatibility issues.</li> <li>• Pre-set dimmer with on/off switch offers excellent dimming performance: 100%-1%.</li> <li>• Manages 120V AC input to control 12V or 24V constant voltage lighting systems.</li> </ul>	<b>Installation Benefits</b> <ul style="list-style-type: none"> <li>• Eliminates the time and guesswork of finding compatible options.</li> <li>• All-in-one product saves time in ordering, tracking, and installing over multiple components.</li> <li>• Installs in a standard single-gang wall box.</li> </ul>						
<b>Product Benefits</b> <ul style="list-style-type: none"> <li>• All-in-one integrated LED Driver + Dimmer switch eliminates switch/driver compatibility issues.</li> <li>• Pre-set dimmer with on/off switch offers excellent dimming performance: 100%-1%.</li> <li>• Manages 120V AC input to control 12V or 24V constant voltage lighting systems.</li> </ul>	<b>Installation Benefits</b> <ul style="list-style-type: none"> <li>• Eliminates the time and guesswork of finding compatible options.</li> <li>• All-in-one product saves time in ordering, tracking, and installing over multiple components.</li> <li>• Installs in a standard single-gang wall box.</li> </ul>								
<b>Compatible Fixtures</b>	4T Series 12V, 4D Series 12V, 6T Series 24V Dry, 6T Series 24V Damp*, 6D Series 24V, Hard Strips 24V								
<b>Warranty</b>	5-year limited warranty. See <a href="http://Kichler.com/warranty">Kichler.com/warranty</a> for complete details.								
<b>Build a System</b>	To build a complete lighting system select from the following: Product (pages 92-99) + Power Supply (below) + Leads & Interconnects (pages 106-107) + Accessories (below)								
<b>Power Supply Models</b> SELV	<table border="1"> <tr> <td rowspan="2"><b>12V</b></td> <td><b>4DD12V040WH</b> 12V 40W with white face plate</td> <td rowspan="4"> </td> </tr> <tr> <td><b>4DD12V060WH</b> 12V 60W with white face plate</td> </tr> <tr> <td rowspan="2"><b>24V</b></td> <td><b>6DD24V060WH</b> 24V 60W with white face plate</td> </tr> <tr> <td><b>6DD24V100WH</b> 24V 100W with white face plate</td> </tr> </table>	<b>12V</b>	<b>4DD12V040WH</b> 12V 40W with white face plate		<b>4DD12V060WH</b> 12V 60W with white face plate	<b>24V</b>	<b>6DD24V060WH</b> 24V 60W with white face plate	<b>6DD24V100WH</b> 24V 100W with white face plate	
<b>12V</b>	<b>4DD12V040WH</b> 12V 40W with white face plate								
	<b>4DD12V060WH</b> 12V 60W with white face plate								
<b>24V</b>	<b>6DD24V060WH</b> 24V 60W with white face plate								
	<b>6DD24V100WH</b> 24V 100W with white face plate								
<b>Accessories</b> Trim and face plate together.	<table border="1"> <tr> <td><b>Light Almond (ALM)</b> <b>1DDTRIMALM</b></td> <td><b>Black (BK)</b> <b>1DDTRIMBK</b></td> <td><b>Brown (BW)</b> <b>1DDTRIMBW</b></td> <td><b>White (WH)</b> <b>1DDTRIMWH</b></td> </tr> <tr> <td></td> <td></td> <td></td> <td></td> </tr> </table>	<b>Light Almond (ALM)</b> <b>1DDTRIMALM</b>	<b>Black (BK)</b> <b>1DDTRIMBK</b>	<b>Brown (BW)</b> <b>1DDTRIMBW</b>	<b>White (WH)</b> <b>1DDTRIMWH</b>				
<b>Light Almond (ALM)</b> <b>1DDTRIMALM</b>	<b>Black (BK)</b> <b>1DDTRIMBK</b>	<b>Brown (BW)</b> <b>1DDTRIMBW</b>	<b>White (WH)</b> <b>1DDTRIMWH</b>						

\*Provisions can be made to connect to damp tape. Consult our APS team by visiting [Kichler.com/APS](http://Kichler.com/APS).

# Power Supplies

Whether you choose to hardwire your system or plug it in to an existing outlet, Kichler® power supplies deliver consistent, reliable energy, helping to maintain the life of the lighting fixtures.

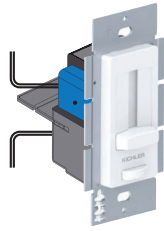
		Power Supplies		
				Compatible Fixtures
<b>Plug-In Power Supply*</b> Simple and Economical, plug-in drivers are the basic power supply.	<b>4TP12V30BK</b> 30W	8' of cord with male DC 2.1 jack on end	4T Series 12V	
	<b>4TP12V60BK</b> 60W		4T Series 12V	
	<b>10190BK30</b> 30W	2.4W minimum load requirement	8T Series 24V	
	<b>10190BK48</b> 48W	120V–240V input	6T Series 24V Dry 6T Series 24V Damp 6T Series 24V RGB	
	<b>10190BK60</b> 60W	Must be installed in dry location	Hard Strips 24V	
<b>Direct Wire Dimmable Power Supplies*</b> <b>Lower Watt:</b> Economical driver ideal for smaller, direct wire, low voltage system projects. CL and ELV dimmer compatible.** <b>Higher Watt:</b> Ideal for larger direct wire projects (i.e., combining multiple products). CL and ELV dimmer compatible.** All Kichler® Direct Wire Dimmable power supplies include wiring compartments. No additional NEMA enclosure required.	<b>4TD12V40BKT</b> 40W dimmable LED power supply		4T Series 12V 4D Series 12V	
	<b>6TD24V10BKT</b> 10W dimmable LED power supply		8T Series 24V 6T Series 24V Dry 6T Series 24V Damp 6T Series 24V RGB	
	<b>6TD24V40BKT</b> 40W dimmable LED power supply		6D Series 24V Hard Strips 24V	
	<b>4TD12V60BKT</b> 60W dimmable LED power supply		4T Series 12V 4D Series 12V	
	<b>6TD24V60BKT</b> 60W dimmable LED power supply		8T Series 24V 6T Series 24V Dry 6T Series 24V Damp 6T Series 24V RGB	
	<b>6TD24V96BKT</b> 96W dimmable LED power supply		6D Series 24V Hard Strips 24V	
	<b>10193BK</b> 8' cord and plug accessory		—	
<b>LED Driver + Dimmer*</b> See page 100 for details.	<b>4DD12V040WH</b> 12V 40W with white face plate		4T Series 12V 4D Series 12V	
	<b>4DD12V060WH</b> 12V 60W with white face plate			
	<b>6DD24V060WH</b> 24V 60W with white face plate		8T Series 24V 6T Series 24V Dry	
	<b>6DD24V100WH</b> 24V 100W with white face plate		6T Series 24V Damp 6D Series 24V Hard Strips 24V	

\*All Power Supplies are Class 2 and either 12V or 24V DC.

\*\*Compatible dimmers will vary based on selected power supply. For recommended dimmers visit [Kichler.com/dimming](http://Kichler.com/dimming).

# Comparing Power Supplies

## Find the right power supply to suit your needs.

From Plug-In to Direct Wire to LED Driver + Dimmer combinations, Kichler Lighting power supplies cover a wide range of project needs. The charts below illustrate the range of operation for each type of driver, and the descriptions below help to further clarify the differences between each offering.

### BEFORE STARTING A PROJECT OR INSTALLATION

1. Calculate the total low voltage wattage load of your project.
2. Select a power supply that places the calculated load between 35% and 90% of the rated wattage.

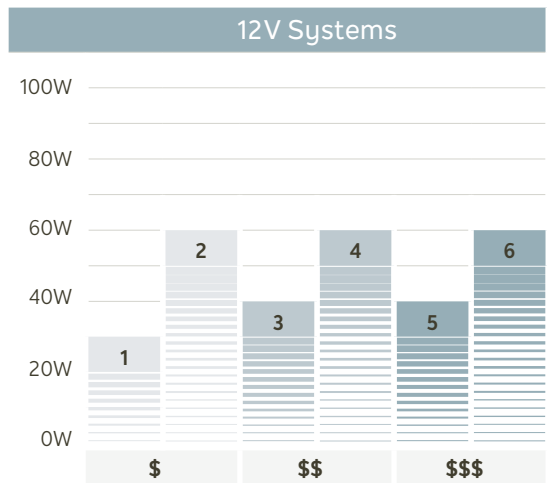

1. 4TP12V30 Plug-in 30W
2. 4TP12V60 Plug-in 60W
3. 4TD12V40 Direct Wire Dimmable Power Supply 40W
4. 4TD12V60 Direct Wire Dimmable Power Supply 60W
5. 4DD12V040WH LED Driver + Dimmer 40W
6. 4DD12V060WH LED Driver + Dimmer 60W

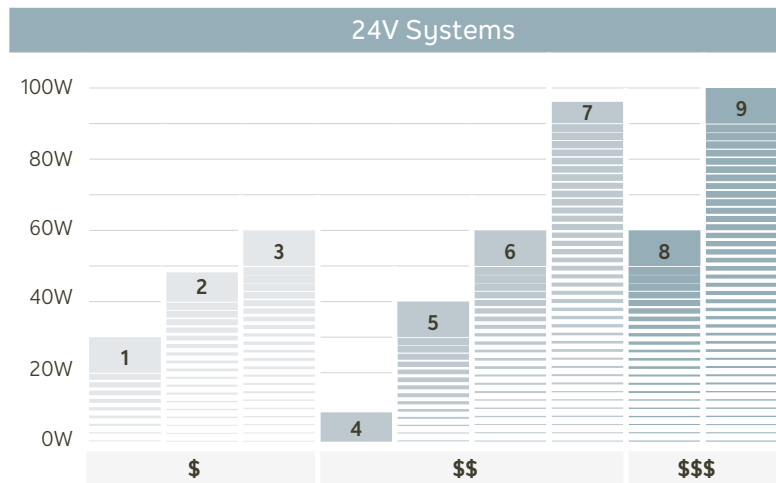

1. 10190BK30 Plug-in 30W
2. 10190BK48 Plug-in 48W
3. 10190BK60 Plug-in 60W
4. 6TD24V10 Direct Wire Dimmable Power Supply 10W
5. 6TD24V40 Direct Wire Dimmable Power Supply 40W
6. 6TD24V60 Direct Wire Dimmable Power Supply 60W
7. 6TD24V96 Direct Wire Dimmable Power Supply 96W
8. 6DD24V060WH LED Driver + Dimmer 60W
9. 6DD24V100WH LED Driver + Dimmer 100W

### PLUG-IN POWER SUPPLIES

Plug-in power supplies are your least expensive option in terms of both cost and labor. Simply connect a DC jack supply lead to your tape and connect to the DC end of the power supply and you are ready to plug in to a standard outlet. The max wattage on a plug-in power supply is typically lower than direct wire power supplies, therefore plug-ins are more ideal for smaller projects. Also, unless prior planning allows for the outlet to be hidden, the cord to the nearest outlet might be visible.

### DIRECT WIRE DIMMABLE POWER SUPPLIES

Direct wire dimmable power supplies offer voltage control to help manage the power to your LED lighting system – ultimately maintaining the life of the product. These power supplies have an integrated wiring component – so no additional NEMA accessory component is required. This type of power supply will be mid-tier in terms of expense (cost + labor) as it requires prior planning and access to wall wiring. However, a greater amount of lighting can be connected to higher wattage models - maximizing the number of power supplies needed per design. Those with lower wattage are ideal for islands or small jobs to avoid having to run additional wire to remote installations.

### LED DRIVER + DIMMER

Having a driver + dimmer in one may seemingly appear to be the most expensive option; however it is a quite cost-effective option. With the driver + dimmer in one, you are purchasing, stocking, and installing one item – eliminating the need to install a dimmer separately. The driver + dimmer in one also reduces time spent selecting a compatible dimmer as that has been done for you.

# Voltage Drop

## Voltage Drop Charts

For best performance and lumen output, ensure proper wire gauge is installed to compensate for voltage drop of low voltage circuits.

12V Voltage Drop & Wire Length Distance Chart

	5W 0.42A	10W 0.83A	20W 1.67A	30W 2.5A	40W 3.33A	50W 4.17A	60W 5A
18 AWG	65 ft.	32 ft.	16 ft.	10 ft.	8 ft.	6 ft.	5 ft.
16 AWG	100 ft.	50 ft.	25 ft.	16 ft.	12 ft.	10 ft.	8 ft.
14 AWG	160 ft.	79 ft.	39 ft.	26 ft.	20 ft.	16 ft.	13 ft.
12 AWG	240 ft.	120 ft.	59 ft.	39 ft.	30 ft.	24 ft.	20 ft.
10 AWG	392 ft.	196 ft.	98 ft.	65 ft.	49 ft.	39 ft.	32 ft.

- Determine load size.** Lets assume the load is 55W. Round up to the nearest load.
- Determine distance from power supply to load.** Let's assume the distance is 32 ft. Round up to the nearest distance.
- See the recommended wire gauge** to install to eliminate excess voltage drop. Recommended wire gauge is 10AWG.

24V Voltage Drop & Wire Length Distance Chart

	5W 0.21A	10W 0.42A	20W 0.83A	30W 1.25A	40W 1.67A	50W 2.08A	60W 2.5A	70W 2.92A	80W 3.33A	90W 3.75A	100W 4.17A
18 AWG	261 ft.	130 ft.	65 ft.	43 ft.	32 ft.	26 ft.	21 ft.	18 ft.	16 ft.	14 ft.	13 ft.
16 AWG	401 ft.	200 ft.	100 ft.	66 ft.	50 ft.	40 ft.	33 ft.	28 ft.	25 ft.	22 ft.	20 ft.
14 AWG	639 ft.	319 ft.	160 ft.	106 ft.	79 ft.	63 ft.	53 ft.	45 ft.	39 ft.	35 ft.	31 ft.
12 AWG	959 ft.	479 ft.	240 ft.	160 ft.	120 ft.	95 ft.	79 ft.	68 ft.	59 ft.	53 ft.	47 ft.
10 AWG	1570 ft.	785 ft.	392 ft.	261 ft.	196 ft.	157 ft.	130 ft.	112 ft.	98 ft.	87 ft.	78 ft.

# Low Voltage Wire

Kichler Lighting in-wall rated wire not only helps you keep unsightly wires hidden – it also does it cost effectively. Because our 14 AWG, 16 AWG, and 18 AWG wires are braided, they're slimmer and more flexible than comparable gauge wires – meaning less hassle during installation. Kichler® wire is also compliant with the National Electrical Safety Standards for in-wall lighting and can reduce bill of material costs over that of Romex.™ These wires are ideal for use with 12V tape, 24V tape, hard strips or accent discs.

## In-Wall Rated Wire



**5W14G250 WH**  
14 AWG low voltage wire  
250'  
CL3P rated



**5W16G250 WH**  
16 AWG low voltage wire  
250'  
CMP rated

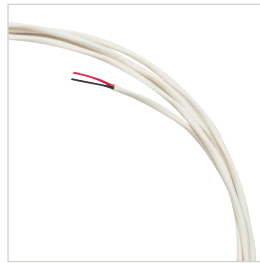

**5W18G250 WH**  
18 AWG low voltage wire  
250'  
CM rated



**5W14G500 WH**  
14 AWG low voltage wire  
500'  
CL3P rated



**5W16G500 WH**  
16 AWG low voltage wire  
500'  
CMP rated



**5W18G500 WH**  
18 AWG low voltage wire  
500'  
CM rated

## Low Voltage Wire – Class 2 Rated

**The best choice outside of the wall: 24 AWG.**

This low voltage wire works perfectly for any Class 2 wiring project, since the 24 AWG wire is durable enough to be soldered when you choose not to use connectors. It's also the best option for Kichler ultra-high output tape.

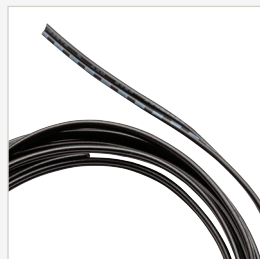

**5W24G250 BK, WH**  
24 AWG low voltage wire  
250'  
CL2 rated  
**Not for in-wall use**



# Low Voltage Wire







## In-wall NEC rated wire types and applications

Low voltage, in-wall rated wire comes in many forms that work together to create a versatile lighting system. Here we depict wiring in general purpose areas to illuminate recommended tape light installations. The main floor is connected to the second level with vertical floor to floor wire commonly known as riser (can be substituted with plenum wire). Plenum-rated wire can then be used throughout drop ceilings where ventilation requires higher standards.

<b>CM</b>	Communications general purpose cable is best suited for common areas – the open areas in which we live and work. So, when looking for in-wall wire for cabinet-to-cabinet, hanging shelf or other non-plenum or non-riser (vertical between floors) installations, this option works well.
<b>CMP</b>	Communications plenum cable offers a flame retardant coating that makes the product suitable for spaces above dropped ceilings or below raised floors that are used for heating ventilation or air conditioning.
<b>CL3P</b>	Class 3 plenum cable allows the wire to take on higher levels of voltage (300V) than Class 2 (150V). This plenum-rated product is suitable for spaces above dropped ceilings or below raised floors that are used for heating ventilation or air conditioning.







Connecting your low voltage system together requires the right supply leads and interconnect accessories. These allow you to link your tape to another run, to low voltage wire or to the power supply.

Power Supply Leads and Inline Accessories					
Available Finishes	Black (BK), White (WH)				
				Compatible Fixtures	
<b>Power Supply Leads</b> Connects tape light to power supplies or controls. Cannot be used as an interconnect cable.	2' DC jack supply lead	Dry	<b>1SL2</b> BK, WH	4T Series 12V* 6T Series 24V	
			<b>1SL2RGB</b> BK, WH	6T Series 24V RGB	
		Damp	<b>2SL2</b> WH	6T Series 24V Damp	
	8' DC jack supply lead	Dry	<b>1SL8</b> BK, WH	4T Series 12V* 6T Series 24V	
			<b>1SL8RGB</b> BK, WH	6T Series 24V RGB	
		Damp	<b>2SL8</b> WH	6T Series 24V Damp	
	2' supply lead No DC connector	Dry	<b>1SLW2</b> BK, WH	4T Series 12V* 6T Series 24V	
			<b>2SLW2</b> WH	6T Series 24V Damp	
	8' supply lead No DC connector	Dry	<b>1SLW8</b> BK, WH	4T Series 12V* 6T Series 24V	
			<b>2SLW8</b> WH	6T Series 24V Damp	
<b>Splice Box</b> Intended for low voltage connections only.	<b>10189</b> BK, WH Accepts max. 14 AWG wire (4) 3/8" size K.O. 2.375" L x 2.375" W x 1" H Must be installed in dry location		4T Series 12V 4D Series 12V 6T Series 24V Dry, 6T Series 24V Damp 6T Series 24V RGB 6D Series 24V Hard Strips 24V		
<b>Inline Dimmer</b> For 12V or 24V output side of power supply.	<b>10198</b> BK, WH 0-100% dimming 48W max. For indoor use only		4T Series 12V 6T Series 24V Dry Hard Strips 24V		
<b>Inline DC Splitter</b>	<b>1DC2</b> BK, WH 2-way DC splitter		4T Series 12V, 6T Series 24V Dry, Hard Strips 24V		
	<b>1DC3</b> BK, WH 3-way DC splitter		4T Series 12V, 6T Series 24V Dry, Hard Strips 24V		
<b>Switches</b>	<b>1DCSWITCH</b> BK, WH In-line DC low voltage switch		4T Series 12V, 6T Series 24V Dry, Hard Strips 24V		

\*4T Series only available in White (WH)

# Interconnect Cables

Available Finishes		Connectors and Interconnect Cables			
		Black (BK), White (WH)			
Interconnects				Compatible Fixtures	
<p><b>Interconnects</b> Used to connect two sections of tape light together or for making tight turns.</p>	Inline splice	Dry	<b>1C1</b> BK, WH	4T Series 12V*, 6T Series 24V	
			<b>1C1RGB</b> BK, WH	6T Series 24V RGB	
	Damp	<b>2C1</b> WH	6T Series 24V Damp		
2" interconnect cable	Dry		<b>1IC02</b> BK, WH	4T Series 12V*, 6T Series 24V	
			<b>1IC02RGB</b> BK, WH	6T Series 24V RGB	
	Damp	<b>2IC02</b> WH	6T Series 24V Damp		
6" interconnect cable	Dry		<b>1IC06</b> BK, WH	4T Series 12V*, 6T Series 24V	
			<b>2IC06</b> WH	6T Series 24V Damp	
12" interconnect cable	Dry		<b>1IC12</b> BK, WH	4T Series 12V*, 6T Series 24V	
			<b>1IC12RGB</b> BK, WH	6T Series 24V RGB	
	Damp	<b>2IC12</b> WH	6T Series 24V Damp		
36" interconnect cable	Dry		<b>1IC36</b> BK, WH	4T Series 12V*, 6T Series 24V	
			<b>1IC36RGB</b> BK, WH	6T Series 24V RGB	
	Damp	<b>2IC36</b> WH	6T Series 24V Damp		
96" interconnect cable	Dry		<b>1IC96</b> BK, WH	4T Series 12V*, 6T Series 24V	
			<b>1IC96RGB</b> BK, WH	6T Series 24V RGB	
	Damp	<b>2IC96</b> WH	6T Series 24V Damp		

\*4T Series only available in White (WH)

## Pro Series – 8FT Length; Components À La Carte

### Sleek



1TEC1SKSF8SIL

### Rod



1TEC1RDSF8SIL

### Sconce

#### Sconce – Single Sided



1TEC2S1SF8SIL

#### Sconce – Double Sided



1TEC4S2SF8SIL

### In-Wall Mud-In

#### Standard



1TEC2SMRC8SIL

#### Deep



1TEC2DMRC8SIL

#### Extra Wide / Deep



1TEC6EMRC8SIL

### Corridor

#### Corridor – Broad/Transitional



1TEC1C1RC8SIL

#### Corridor – Thin/Contemporary



1TEC1C2RC8SIL

### Cove Ceiling

#### Direct 1 (1/2" drywall)



1TEC1DC1DW8SIL

#### Direct 2 (5/8" drywall)

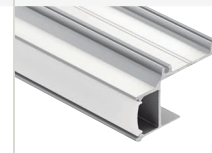

1TEC1DC2DW8SIL

#### Indirect 1 (1/2" drywall)

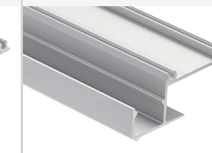

1TEC1IC1DW8SIL

#### Indirect 2 (5/8" drywall)

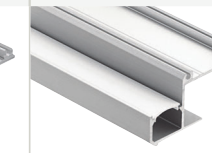

1TEC1IC2DW8SIL

### Crown

#### Molding – Contemporary



1TEC2M1SF8SIL

#### Molding – Transitional



1TEC2M2SF8SIL

### Tread



1TEC4TRSF8SIL

### Arches

#### Ceiling-to-Wall



1TEC2W1RC8SIL

#### Ceiling-Edge



1TEC2W2RC8SIL

#### Center-in-Ceiling



1TEC4W3RC8SIL

### Floor



1TEC1FLRC8SIL

## Enhanced Series – 8ft Length; Components À La Carte

### Surface Mount

These channels install onto a surface to create sturdy under-cabinet, shelving or even step lighting. Miter cut and connect for custom shapes.

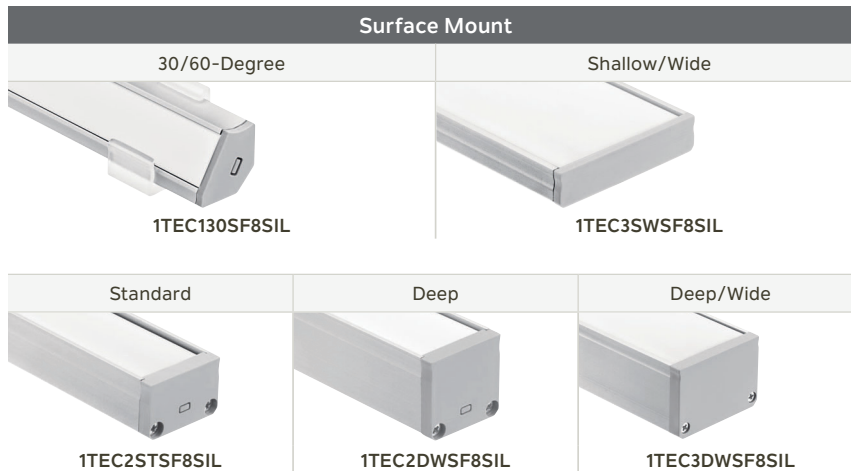

### Recessed Mount

By creating space within drywall, shelving or other surfaces, recessed channels can then be inset for a seamless, built-in lighting effect. Miter cut and connect for custom shapes.



## Standard Series – 8ft Length À La Carte; 2, 4, & 8ft Kits

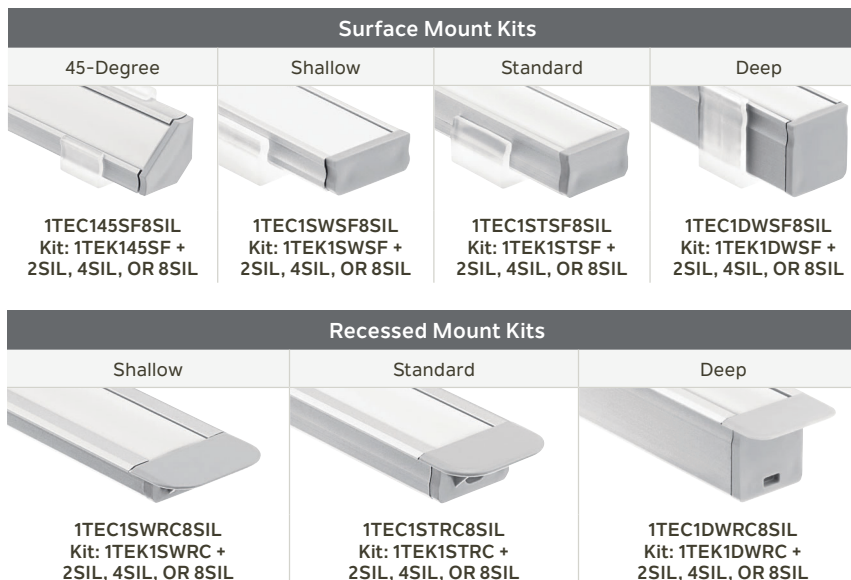

Kichler Lighting now offers aluminum extruded channels to make it easier to design with light.

The Pro Series (page 108) allows you to integrate light into ceilings, walls and floors and create unique, and often unexpected, lighting effects.

The Enhanced Series (page 109, top) may seem like a straightforward collection of channels, however wider widths and varying depths take your lighting from accent to ambient.

The Standard Series (page 109, bottom) lives up to its name for standard accent lighting installations. The series offers an array of ordering options, including kits that come with the lens, mounting clips and end caps.

Although the Standard Series is the only group offered in kits, all three series can be ordered a-la-carte to create your ideal channel assembly.

### Kichler® TE Series Channels:

- Are designed to hold LED tape light – Standard and High output 8T, 6T and 4T models (Tape sold separately).
- Come in varying widths and depths to create a desired end effect.
- Have both Surface and Recessed mount options – look for SF or RC in model number.
- Pair with lenses, end caps, mounting clips, and accessories for a polished look.
- Can be trimmed to unique lengths and shapes.
- Can be paired with the suspension cable (most models) to create a unique pendant.

For inspiration plus coordinating lenses, end caps, mounting clips and accessories, visit the Kichler.com Tape and Channels section.

Broaden your installation options with track and diffusers that allow you to customize the direction and appearance of your tape light.

Tracks and End Caps				
			Compatible Fixtures	
90° Aluminum Track*	10171 BK, WH – 12" 10-pack	0.5" W x 0.5625" H  Includes 11 end caps  Pre-installed screws every 6"	4T Series 12V 6T Series 24V Dry 6T Series 24V Damp 6T Series 24V RGB	
	10170 BK, WH – 36" 10-pack			
90° End Caps	10177 BK, WH 5-pack		10171 BK, WH 10170 BK, WH	
45° Aluminum Track*	10173 BK, WH – 12" 10-pack	0.5" W x 0.5" H  Includes 11 end caps  Pre-installed screws every 6"	4T Series 12V 6T Series 24V Dry 6T Series 24V Damp 6T Series 24V RGB	
	10172 BK, WH – 36" 10-pack			
45° End Caps	10178 BK, WH 5-pack		10173 BK, WH 10172 BK, WH	
U-Channel Aluminum Track*	10175 BK, WH – 12" 10-pack	0.5" W x 0.75" H  Includes 11 end caps  Pre-installed screws every 6"	4T Series 12V 6T Series 24V Dry 6T Series 24V Damp 6T Series 24V RGB	
	10174 BK, WH – 36" 10-pack			
U-Channel End Caps	10176 BK, WH 5-pack		10175 BK, WH 10174 BK, WH	
Diffuser	10179 – 36" Cut to size		10175 BK, WH 10174 BK, WH	
Plastic Track	12330 BK, WH – 36" 10-pack Pre-installed screws every 6" Snaps on the score every 6"		4T Series 12V 6T Series 24V Dry (except ultra-high) 6T Series 24V Damp 6T Series 24V RGB	

\*Recommended for ultra-high output tape installations



## LED Step & Hall Lighting



# LED Step & Hall Lighting

LED Step and Hall fixtures are the prime example of lighting with purpose. Whether illuminating a corridor, or providing visibility to a stairwell, these small LED items help guide the way. The fixtures are 120V, allowing for direct wire into a standard single gang junction box, and offer ease of install with captive screws and push-in wire connectors. The broad array of faceplates and finishes bring a touch of sophistication to the design.

To learn more about our FREE layout design and technical support services visit [Kichler.com/APS](http://Kichler.com/APS)





Every light engine is engineered specifically for its matching faceplate to achieve optimal light quality and greater efficiency. The product is easy to install, thanks to captive mounting screws and push-in wire connectors that can accommodate daisy chain wiring for added simplicity.

## Available Faceplate Designs



- 12672** ALM, AZ, NI, WH  
 • Shown in Almond (ALM)  
 • 4.875" W x 3.125" H  
 • Dimmable  
 • Screwless faceplate  
 • 1 Watt



- 12662** ALM, AZ, NI, WH  
 • Shown in Almond (ALM)  
 • 4.875" W x 3.125" H  
 • 1 Watt



- 12673** ALM, AZ, NI, WH  
 • Shown in Architectural Bronze (AZ)  
 • 4.875" W x 3.125" H  
 • Dimmable  
 • Screwless faceplate  
 • 1 Watt



- 12663** ALM, AZ, NI, WH  
 • Shown in Architectural Bronze (AZ)  
 • 4.875" W x 3.125" H  
 • 1 Watt



- 12674** ALM, AZ, NI, WH  
 • Shown in Brushed Nickel (NI)  
 • 4.875" W x 3.125" H  
 • Dimmable  
 • Screwless faceplate  
 • 1 Watt



- 12664** ALM, AZ, NI, WH  
 • Shown in Brushed Nickel (NI)  
 • 4.875" W x 3.125" H  
 • 1 Watt



- 12675** ALM, AZ, NI, WH  
 • Shown in White (WH)  
 • 4.875" W x 3.125" H  
 • Dimmable  
 • Screwless faceplate  
 • 1 Watt



- 12665** ALM, AZ, NI, WH  
 • Shown in White (WH)  
 • 4.875" W x 3.125" H  
 • 1 Watt



- 12600** AZ, WH  
 • Shown in Architectural Bronze (AZ)  
 • 4.5" W x 2.75" H  
 • 1.5 Watt



- 12602** AZ, WH  
 • Shown in White (WH)  
 • 4.5" W x 2.75" H  
 • 1 Watt

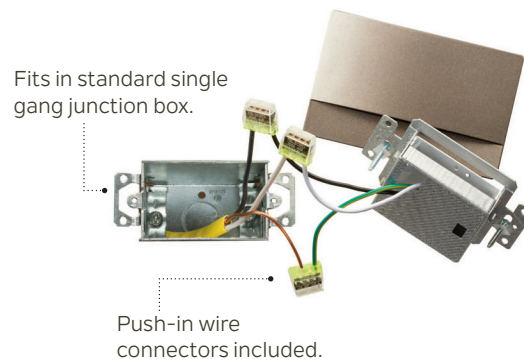



- 12676** ALM, AZ, NI, WH  
 • Shown in Almond (ALM)  
 • 3.125" W x 4.875" H  
 • Dimmable  
 • Screwless faceplate  
 • 1 Watt



- 12666** ALM, AZ, NI, WH  
 • Shown in Almond (ALM)  
 • 3.125" W x 4.875" H  
 • 1 Watt



- 12677** ALM, AZ, NI, WH  
 • Shown in Architectural Bronze (AZ)  
 • 3.125" W x 4.875" H  
 • Dimmable  
 • Screwless faceplate  
 • 1 Watt



- 12667** ALM, AZ, NI, WH  
 • Shown in Architectural Bronze (AZ)  
 • 3.125" W x 4.875" H  
 • 1 Watt



- 12678** ALM, AZ, NI, WH  
 • Shown in Brushed Nickel (NI)  
 • 3.125" W x 4.875" H  
 • Dimmable  
 • Screwless faceplate  
 • 1 Watt



- 12668** ALM, AZ, NI, WH  
 • Shown in Brushed Nickel (NI)  
 • 3.125" W x 4.875" H  
 • 1 Watt



- 12604** AZ, WH  
 • Shown in Architectural Bronze (AZ)  
 • 2.75" W x 4.5" H  
 • 1 Watt



- 12606** AZ, WH  
 • Shown in White (WH)  
 • 2.75" W x 4.5" H  
 • 1.5 Watt

## Features

### Installation Features

- Fast installation with push-in wire connectors and captive mounting screws
- Snap-off tabs to retrofit into any standard junction box/receptacle
- Integral 120V input driver
- Aluminum housing with die-cast aluminum faceplates
- IC rated
- ETL rated for damp locations
- ADA compliant

### Light Features

- Light output: 8-30 lumens, visit [Kichler.com](http://Kichler.com) for details
- Power consumption: 1 Watt
- Color Rendering Index (CRI): >80
- Correlated Color Temperature (CCT): 3500K +/- 150K
- Balanced lighting – free of shadows, cutoffs and striping



Hall or Wall Installation



Step Installation

## Ceiling Fans



# Ceiling Fans

Kichler Lighting ceiling fans are well designed, with built-in functionality for optimal performance: premium motors, superior controls, and energy-saving features. When installing fans in multi-unit structures like apartments or hotels, AC motor fans are recommended. AC motor controls have options to be able to control many fans without interference. In addition, multiple AC fans can be installed on the same circuit—which saves on time and materials.

For an expanded selection of Indoor and Outdoor fans, visit [Kichler.com](http://Kichler.com)

**Indoor** page 118

**Outdoor** page 126

**Accessories** page 129



# Ceiling Fans

## Indoor

15"



LED  
LIGHT KIT

Terna™ LED 300230 NI, OBB, WH

### SPECIFICATIONS

- **Finishes** – Brushed Nickel Finish, Champagne Blades, Etched Cased Opal Glass
- Oil Brushed Bronze® Finish, Oil Brushed Bronze® Blades, Etched Cased Opal Glass (shown)
- White Finish, White Blades, Etched Cased Opal Glass
- **Blades** (5) Included • Variable Pitch • 15" Sweep
- Non-Reversible • Polycarbonate
- **Downlight** Integrated. 17-W Dimmable LED Platform, 1,600 Lumens, 80 CRI, 3,000 CCT
- **Included Control** 3-Speed CoolTouch™ Full Function
- **Optional Controls** 370038MULTR, 371045MUL
- **Mounting Slope** – Pitch 22° or 4/12 • **Lead Wire** 78"
- **ELT Listed** Indoor • **Hanging Weight** 15.87 lbs.
- **Warranty** Limited Lifetime • **Not Low Ceiling Adaptable**
- **Motor Size/Type** 153mm x 15mm, AC • **AMPS** 0.25 on High
- **RPM** 318 on High

AIRFLOW	POWER USAGE	AIRFLOW EFFICIENCY
359 Cubic Ft. Per Minute on High	32 Watts on High (Excludes Lights)	11 Cubic Ft. Per Minute Per Watt

52"



LED  
LIGHT KIT

Lucian™ LED 330000 NI, OZ, PN

### SPECIFICATIONS

- **Finishes** – Brushed Nickel Finish, Silver/Walnut Blades, Etched Cased Opal Glass
- Olde Bronze® Finish, Cherry/Walnut Blades, Etched Cased Opal Glass (shown)
- Polished Nickel Finish, Silver/Distressed Black Blades, Etched Cased Opal Glass
- **Blades** (5) Included • 14° Pitch • 52" Sweep • Reversible • Wood
- **Downlight** Integrated. 17-W LED Platform, 1,600 Lumens, 80 CRI, 3,000 CCT
- **Included Control** Wall Control System – Basic
- **Optional Controls** 337214TR
- **Mounting Slope** – Pitch 30° or 7/12 • **Lead Wire** 78"
- **cUL Listed** Indoor • **Hanging Weight** 21.8 lbs.
- **Warranty** Limited Lifetime • **Not Low Ceiling Adaptable**
- **Motor Size/Type** 172mm x 20mm, AC • **AMPS** 0.60 on High
- **RPM** 155 on High

AIRFLOW	POWER USAGE	AIRFLOW EFFICIENCY
5356 Cubic Ft. Per Minute on High	72 Watts on High (Excludes Lights)	75 Cubic Ft. Per Minute Per Watt

54"



LED  
LIGHT KIT

Geno™ LED 330001 BSS, MWH, OZ

### SPECIFICATIONS

- **Finishes** – Brushed Stainless Steel Finish, Walnut/Silver Blades, Etched Cased Opal Glass (shown)
- Matte White Finish, Matte White Blades
- Olde Bronze® Finish, Cherry/Walnut Blades
- **Blades** (5) Included • 14° Pitch • 54" Sweep • Reversible • Wood
- **Downlight** Integrated. 17-W LED Platform, 1,600 Lumens, 80 CRI, 3,000 CCT
- **Included Control** Remote Control System – Basic
- **Optional Controls** 370039MULTR
- **Mounting Slope** – Pitch 30° or 7/12 • **Lead Wire** 78"
- **cUL Listed** Indoor • **Hanging Weight** 24.5 lbs.
- **Warranty** Limited Lifetime • **Not Low Ceiling Adaptable**
- **Motor Size/Type** 188mm x 25mm, AC • **AMPS** 0.67 on High
- **RPM** 157 on High

AIRFLOW	POWER USAGE	AIRFLOW EFFICIENCY
5147 Cubic Ft. Per Minute on High	80 Watts on High (Excludes Lights)	65 Cubic Ft. Per Minute Per Watt

52"



LED  
LIGHT KIT

Vassar™ LED 330002 NI, OZ, WH

### SPECIFICATIONS

- **Finishes** – Brushed Nickel Finish, Silver/Walnut Blades, Etched Cased Opal Glass
- Olde Bronze® Finish, Cherry/Walnut Blades, Etched Cased Opal Glass (shown)
- White Finish, White/Silver Blades, Etched Cased Opal Glass
- **Blades** (3) Included • 14° Pitch • 52" Sweep • Reversible • Wood
- **Downlight** Integrated. 17-W LED Platform, 1,600 Lumens, 80 CRI, 3,000 CCT
- **Included Control** Wall Control System – Basic
- **Optional Controls** 337214TR
- **Mounting Slope** – Pitch 30° or 7/12 • **Lead Wire** 78"
- **cUL Listed** Indoor • **Hanging Weight** 17.2 lbs.
- **Warranty** Limited Lifetime • **Not Low Ceiling Adaptable**
- **Motor Size/Type** 153mm x 17mm, AC • **AMPS** 0.52 on High
- **RPM** 182 on High

AIRFLOW	POWER USAGE	AIRFLOW EFFICIENCY
4811 Cubic Ft. Per Minute on High	59 Watts on High (Excludes Lights)	81 Cubic Ft. Per Minute Per Watt



Starkk™ LED 330180 MWH, NBR, NI, OZ, PN

SPECIFICATIONS

- **Finishes** – Matte White Finish, Matte White Blades, Etched Cased Opal Glass
- Natural Brass Finish, Medium Cherry/Dark Cherry Blades, Etched Cased Opal Glass (shown)
- Brushed Nickel Finish, Silver/Walnut Blades, Etched Cased Opal Glass
- Olde Bronze® Finish, Cherry/Walnut Blades, Etched Cased Opal Glass
- Polished Nickel Finish, Silver/Walnut Blades, Etched Cased Opal Glass
- **Blades** (5) Included • 14" Pitch • 60" Sweep • Reversible • Wood
- **Downlight** Integrated. 17-W LED Platform, 1,600 Lumens, 80 CRI, 3,000 CCT
- **Included Control** Pull Chain • **Optional Controls** 371042MUL
- **Mounting Slope** – Pitch 30° or 7/12 • **Lead Wire** 78"
- **cUL Listed** Indoor • **Hanging Weight** 26.3 lbs.
- **Warranty** Limited Lifetime • **Not Low Ceiling Adaptable**
- **Motor Size/Type** 188mm x 25mm, AC • **AMPS** 0.60 on High
- **RPM** 113 on High

AIRFLOW	POWER USAGE	AIRFLOW EFFICIENCY
5476	72	76
Cubic Ft. Per Minute on High	Watts on High (Excludes Lights)	Cubic Ft. Per Minute Per Watt



Starkk™ LED 330174 MWH, NBR, NI, OZ, PN

SPECIFICATIONS

- **Finishes** – Matte White Finish, Matte White Blades, Etched Cased Opal Glass (shown)
- Natural Brass Finish, Medium Cherry/Dark Cherry Blades, Etched Cased Opal Glass (shown)
- Brushed Nickel Finish, Silver/Walnut Blades, Etched Cased Opal Glass
- Olde Bronze® Finish, Cherry/Walnut Blades, Etched Cased Opal Glass
- Polished Nickel Finish, Silver/Walnut Blades, Etched Cased Opal Glass
- **Blades** (5) Included • 12" Pitch • 52" Sweep • Reversible • Wood
- **Downlight** Integrated. 17-W Dimmable LED Platform, 1,600 Lumens, 80 CRI, 3,000 CCT
- **Included Control** Pull Chain • **Optional Controls** 371042MUL
- **Mounting Slope** – Pitch 30° or 7/12 • **Lead Wire** 78"
- **cUL Listed** Indoor • **Hanging Weight** 20.75 lbs.
- **Warranty** Limited Lifetime • **Not Low Ceiling Adaptable**
- **Motor Size/Type** 153mm x 17mm, AC • **AMPS** 0.46 on High
- **RPM** 135 on High

AIRFLOW	POWER USAGE	AIRFLOW EFFICIENCY
4051	54	75
Cubic Ft. Per Minute on High	Watts on High (Excludes Lights)	Cubic Ft. Per Minute Per Watt



Starkk™ LED 330171 MWH, NBR, NI, OZ, PN

SPECIFICATIONS

- **Finishes** – Matte White Finish, Matte White Blades, Etched Cased Opal Glass
- Natural Brass Finish, Medium Cherry/Dark Cherry Blades, Etched Cased Opal Glass
- **Brushed Nickel Finish, Silver/Walnut Blades, Etched Cased Opal Glass (shown)**
- Olde Bronze® Finish, Cherry/Walnut Blades, Etched Cased Opal Glass
- Polished Nickel Finish, Silver/Walnut Blades, Etched Cased Opal Glass
- **Blades** (5) Included • 12" Pitch • 42" Sweep • Reversible • Wood
- **Downlight** Integrated. 17-W Dimmable LED Platform, 1,600 Lumens, 80 CRI, 3,000 CCT
- **Included Control** Pull Chain • **Optional Controls** 371042MUL
- **Mounting Slope** – Pitch 30° or 7/12 • **Lead Wire** 78"
- **cUL Listed** Indoor • **Hanging Weight** N/A • **Warranty** Limited Lifetime
- **Not Low Ceiling Adaptable** • **Motor Size/Type** 153mm x 12mm, AC
- **AMPS** 0.39 on High • **RPM** 215 on High

AIRFLOW	POWER USAGE	AIRFLOW EFFICIENCY
3482	47	74
Cubic Ft. Per Minute on High	Watts on High (Excludes Lights)	Cubic Ft. Per Minute Per Watt



Starkk™ 300173 MWH, NBR, NI, OZ, PN, SBK, WH

SPECIFICATIONS

- **Finishes** – Matte White Finish, Matte White Blades, Satin Etched Glass
- Natural Brass Finish, Medium Cherry/Dark Cherry Blades, Satin Etched Glass
- **Brushed Nickel Finish, Silver/Walnut Blades, Satin Etched Glass (shown)**
- Olde Bronze® Finish, Cherry/Walnut Blades, Satin Etched Glass
- Polished Nickel Finish, Silver/Walnut Blades, Satin Etched Glass
- Satin Black Finish, Satin Black Blades, Satin Etched Glass
- White Finish, White Blades, Satin Etched Glass
- **Blades** (5) Included • 12" Pitch • 52" Sweep • Reversible • Wood
- **Downlight** Integrated. Uses (1) E-11 75-W JD Lamp
- **Included Control** Pull Chain • **Optional Controls** 337001WH, 371042MUL, 371082 • **Mounting Slope** – Pitch 30° or 7/12
- **Lead Wire** 78" • **cUL Listed** Indoor • **Hanging Weight** 17.9 lbs.
- **Warranty** Limited Lifetime • **Motor Size/Type** 153mm x 17mm, AC
- **AMPS** 0.46 on High • **RPM** 136 on High

AIRFLOW	POWER USAGE	AIRFLOW EFFICIENCY
3982	54	74
Cubic Ft. Per Minute on High	Watts on High (Excludes Lights)	Cubic Ft. Per Minute Per Watt

# Ceiling Fans

## Indoor



**Skye™ LED 300251 NI, OLZ, WH**

### SPECIFICATIONS

- **Finishes** – Brushed Nickel Finish, Silver/Walnut Blades, Satin Etched Glass (shown)
- Oiled Bronze® Finish, Medium Cherry/Dark Cherry Blades, Satin Etched Glass
- White Finish, White Blades, Satin Etched Glass
- **Blades** (5) Included • 14° Pitch • 54" Sweep • Reversible • Wood
- **Downlight** Integrated. Uses (2) B10 5-W LED Bulbs
- **Included Control** Wall Control System – Full Function
- **Optional Controls** 337009WHTR
- **Mounting Slope** – Pitch 30° or 7/12 • **Lead Wire** 78"
- **cETL Listed** Indoor • **Hanging Weight** 30.0 lbs.
- **Warranty** Limited Lifetime • **Not Low Ceiling Adaptable**
- **Motor Size/Type** 188mm x 20mm, AC • **AMPS** 0.82 on High
- **RPM** 194 on High

AIRFLOW	POWER USAGE	AIRFLOW EFFICIENCY
6637	97	68
Cubic Ft. Per Minute on High	Watts on High (Excludes Lights)	Cubic Ft. Per Minute Per Watt



**Motu™ 330010 NI, SBK**

### SPECIFICATIONS

- **Finishes** – Brushed Nickel Finish, Nickel Blades, (shown)
- Satin Black Finish, Satin Black Blades
- **Blades** (3) Included • 35° Pitch • 60" Sweep • Non-Reversible • ABS
- **Downlight** N/A
- **Included Control** 4-Speed Slide Control
- **Optional Controls** 370040, 370032MUL
- **Mounting Slope** – Pitch 30° or 7/12 • **Lead Wire** 78"
- **cUL Listed** Indoor • **Hanging Weight** 24.0 lbs.
- **Warranty** Limited Lifetime
- **Not Low Ceiling Adaptable**
- **Motor Size/Type** 188mm x 25mm, AC
- **AMPS** 0.86 on High
- **RPM** 261 on High

AIRFLOW	POWER USAGE	AIRFLOW EFFICIENCY
10,253	100	103
Cubic Ft. Per Minute on High	Watts on High (Excludes Lights)	Cubic Ft. Per Minute Per Watt



**Todo™ 330025 BSS, SBK, WH**

### SPECIFICATIONS

- **Finishes** – Brushed Stainless Steel Finish, Brushed Stainless Steel Blades (shown)
- Satin Black Finish, Satin Black Blades
- White Finish, White Blades
- **Blades** (3) Included • 6.5° Pitch • 56" Sweep • Non-Reversible • Steel
- **Downlight** N/A
- **Included Control** 4-Speed Fan Slide Control
- **Optional Controls** 370040, 370032MUL
- **Mounting Slope** – Pitch 30° or 7/12
- **Lead Wire** 78"
- **cUL Listed** Indoor • **Hanging Weight** 18.3 lbs.
- **Warranty** Limited Lifetime • **Not Low Ceiling Adaptable**
- **Motor Size/Type** 188mm x 20mm, AC • **AMPS** 0.79 on High
- **RPM** 267 on High

AIRFLOW	POWER USAGE	AIRFLOW EFFICIENCY
8666	91	95
Cubic Ft. Per Minute on High	Watts on High (Excludes Lights)	Cubic Ft. Per Minute Per Watt



**Monarch™ 300206 BAP, OBB, TZ, WH**

### SPECIFICATIONS

- **Finishes** – Burnished Antique Pewter Finish, Cherry/Weathered White Walnut Blades (shown)
- Oil Brushed Bronze® Finish, Cherry/Walnut Blades
- Tannery Bronze™ Finish, Cherry/Teak Blades
- White Finish, White/Weathered White Walnut Blades
- **Blades** (5) Included • 16° Pitch • 70" Sweep • Reversible • Wood
- **Downlight** N/A
- **Included Control** Wall Control System – Full Function
- **Optional Controls** 337009WHTR
- **Mounting Slope** – Pitch 30° or 7/12
- **Lead Wire** 78"
- **cUL Listed** Indoor • **Hanging Weight** 28.9 lbs.
- **Warranty** Limited Lifetime • **Not Low Ceiling Adaptable**
- **Motor Size/Type** 212mm x 25mm, AC • **AMPS** 0.80 on High
- **RPM** 128 on High

AIRFLOW	POWER USAGE	AIRFLOW EFFICIENCY
9448	97	98
Cubic Ft. Per Minute on High	Watts on High (Excludes Lights)	Cubic Ft. Per Minute Per Watt





60"



**Bowen 330243 MWH, NI, OZ**

**SPECIFICATIONS**

- **Finishes** – Matte White Finish, Matte White Blades
- **Brushed Nickel Finish, Silver/Walnut Blades, (shown)**
- Olde Bronze® Finish, Cherry/Walnut Blades
- **Blades** (5) Included • 14° Pitch • 60" Sweep • Reversible • Wood
- **Downlight** N/A
- **Included Control** Pull Chain
- **Optional Controls** 371042MUL, 337001WH, 371082
- **Mounting Slope** – Pitch 30° or 7/12
- **Lead Wire** 78"
- **cUL Listed** Indoor • **Hanging Weight** 27.5 lbs.
- **Warranty** Limited Lifetime • **Not Low Ceiling Adaptable**
- **Motor Size/Type** 188mm x 25mm, AC • **AMPS** 0.57 on High
- **RPM** 111 on High

AIRFLOW	POWER USAGE	EFFICIENCY
5190 Cubic Ft. Per Minute on High	67 Watts on High (Excludes Lights)	78 Cubic Ft. Per Minute Per Watt



52"



**Bowen 330242 MWH, NI, OZ**

**SPECIFICATIONS**

- **Finishes** – Matte White Finish, Matte White Blades
- **Brushed Nickel Finish, Silver/Walnut Blades**
- **Olde Bronze® Finish, Cherry/Walnut Blades (shown)**
- **Blades** (5) Included • 14° Pitch • 52" Sweep • Reversible • Wood
- **Downlight** N/A
- **Included Control** Pull Chain
- **Optional Controls** 371042MUL, 337001WH, 371082
- **Mounting Slope** – Pitch 30° or 7/12
- **Lead Wire** 78"
- **cUL Listed** Indoor • **Hanging Weight** 25.3 lbs.
- **Warranty** Limited Lifetime • **Not Low Ceiling Adaptable**
- **Motor Size/Type** 172mm x 14mm, AC • **AMPS** 0.55 on High
- **RPM** 159 on High

AIRFLOW	POWER USAGE	AIRFLOW EFFICIENCY
4411 Cubic Ft. Per Minute on High	67 Watts on High (Excludes Lights)	66 Cubic Ft. Per Minute Per Watt



42"

**Bowen 330241 MWH, NI, OZ**

**SPECIFICATIONS**

- **Finishes** – **Matte White Finish, Matte White Blades (shown)**
- Brushed Nickel Finish, Silver/Walnut Blades
- Olde Bronze® Finish, Cherry/Walnut Blades
- **Blades** (5) Included • 14° Pitch • 42" Sweep • Reversible • Wood
- **Downlight** N/A
- **Included Control** Pull Chain
- **Optional Controls** 371042MUL, 337001WH, 371082
- **Mounting Slope** – Pitch 30° or 7/12
- **Lead Wire** 78"
- **cUL Listed** Indoor • **Hanging Weight** 22 lbs.
- **Warranty** Limited Lifetime • **Not Low Ceiling Adaptable**
- **Motor Size/Type** 153mm x 15mm, AC • **AMPS** 0.41 on High
- **RPM** 199 on High

AIRFLOW	POWER USAGE	AIRFLOW EFFICIENCY
3402 Cubic Ft. Per Minute on High	48 Watts on High (Excludes Lights)	70 Cubic Ft. Per Minute Per Watt



52"



**Leeds™ 300457 AP, NI, OBB**

**SPECIFICATIONS**

- **Finishes** – **Brushed Nickel Finish, Silver/Black Blades, Etched Cased Opal Glass (shown)**
- Oil Brushed Bronze™ Finish, Cherry/Walnut Blades, Etched Cased Opal Glass
- Antique Pewter Finish, Light Cherry/Black Cherry Blades, Etched Cased Opal Glass
- **Blades** (5) Included • 13° Pitch • 52" Sweep • Reversible • Wood
- **Downlight** Integrated. 17-W LED Platform 1,600 Lumens, 80 CRI, 3,000 CCT
- **Included Control** Wall Control System - Basic
- **Optional Controls** 337214TR
- **Mounting Slope** – Pitch 30° or 7/12
- **Lead Wire** 78" • **cUL Listed** Indoor • **Hanging Weight** 24.10 lbs.
- **Warranty** Limited Lifetime • **Not Low Ceiling Adaptable**
- **Motor Size/Type** 172mm x 17mm, AC • **AMPS** 0.55 on High
- **RPM** 178 on High

AIRFLOW	POWER USAGE	AIRFLOW EFFICIENCY
6255 Cubic Ft. Per Minute on High	70 Watts on High (Excludes Lights)	89 Cubic Ft. Per Minute Per Watt

# Ceiling Fans Indoor



**Terra 330247 BAP, MWH, NI, OBB**

### SPECIFICATIONS

- **Finishes** – Burnished Antique Pewter Finish, **Dark Cherry/Weathered White Walnut Blades (shown)**
- Matte White Finish, Matte White/Weathered White Walnut Blades
- Brushed Nickel Finish, Silver/Walnut Blades
- Oil Brushed Bronze™ Finish, Cherry/Walnut Blades
- **Blades** (5) Included • 14° Pitch • 52" Sweep • Reversible • Wood
- **Downlight** N/A
- **Included Control** Pull Chain
- **Optional Controls** 371042MUL, 337001WH, 371082
- **Mounting Slope** – Pitch 30° or 7/12 • **Lead Wire** 78"
- **cUL Listed** Indoor • **Hanging Weight** 28.60 lbs.
- **Warranty** Limited Lifetime
- **Low Ceiling Adaptable** With Purchase of Flush Mount Accessory 337008
- **Motor Size/Type** 172mm x 14mm, AC • **AMPS** 0.60 on High
- **RPM** 161 on High

AIRFLOW	POWER USAGE	AIRFLOW EFFICIENCY
4593	71	65
Cubic Ft. Per Minute on High	Watts on High (Excludes Lights)	Cubic Ft. Per Minute Per Watt



**Terra Select 330248 BAP, MWH, NI, OBB**

### SPECIFICATIONS

- **Finishes** – Burnished Antique Pewter Finish, **Dark Cherry/Weathered White Walnut Blades, White Etched Glass**
- Matte White Finish, Matte White/Weathered White Walnut Blades, White Etched Glass
- Brushed Nickel Finish, Silver/Walnut Blades, White Etched Glass
- **Oil Brushed Bronze® Finish, Cherry/Walnut Blades, Umber Etched Glass (shown)**
- **Blades** (5) Included • 14° Pitch • 52" Sweep • Reversible • Wood
- **Downlight** Removable. Uses (3) E12 B-8 60-W Bulbs
- **Included Control** Pull Chain
- **Optional Controls** 371042MUL, 337001WH, 371082
- **Mounting Slope** – Pitch 30° or 7/12 • **Lead Wire** 78"
- **cUL Listed** Indoor • **Hanging Weight** 18.46 lbs.
- **Warranty** Limited Lifetime • **Low Ceiling Adaptable** With Purchase of Flush Mount Accessory 337008 • **Motor Size/Type** 172mm x 14mm, AC • **AMPS** 0.56 on High • **RPM** 154 on High

AIRFLOW	POWER USAGE	AIRFLOW EFFICIENCY
4972	66	75
Cubic Ft. Per Minute on High	Watts on High (Excludes Lights)	Cubic Ft. Per Minute Per Watt



**Canfield™ XL 300188 DBK, NI, OBB, WH**

### SPECIFICATIONS

- **Finishes** – Distressed Black Finish, **Cherry/Walnut Blades**
- **Brushed Nickel Finish, Cherry/Walnut Blades (shown)**
- Oil Brushed Bronze™ Finish, Cherry/Walnut Blades
- White Finish, White Blades
- **Blades** (5) Included • 14° Pitch • 60" Sweep • Reversible • Wood
- **Downlight** N/A
- **Included Control** Pull Chain
- **Optional Controls** 371042MUL, 337001WH, 371082
- **Mounting Slope** – Pitch 30° or 7/12 • **Lead Wire** 78"
- **cUL Listed** Indoor • **Hanging Weight** 27.83 lbs.
- **Warranty** Limited Lifetime
- **Low Ceiling Adaptable** With Purchase of Flush Mount Accessory 337008
- **Motor Size/Type** 212mm x 25mm, AC • **AMPS** 0.70 on High
- **RPM** 148 on High

AIRFLOW	POWER USAGE	AIRFLOW EFFICIENCY
6785	83	82
Cubic Ft. Per Minute on High	Watts on High (Excludes Lights)	Cubic Ft. Per Minute Per Watt



**Canfield™ Select LED 300026 BSS, OBB**

### SPECIFICATIONS

- **Finishes** – Brushed Stainless Steel Finish, **Medium Oak/Dark Oak Blades, White Cased Opal with Clear Glass**
- **Oil Brushed Bronze™ Finish, Cherry/Walnut Blades, White Cased Opal with Clear Glass (shown)**
- **Blades** (5) Included • 14° Pitch • 52" Sweep • Reversible • Wood
- **Downlight** Removable. 17-W Dimmable LED Platform. 1,600 Lumens, 80 CRI, 3,000K CCT
- **Included Control** Pull Chain
- **Optional Controls** 371042MUL, 337001WH, 371082
- **Mounting Slope** – Pitch 30° or 7/12 • **Lead Wire** 78"
- **cUL Listed** Indoor • **Hanging Weight** 28.60 lbs.
- **Warranty** Limited Lifetime
- **Low Ceiling Adaptable** With Purchase of Flush Mount Accessory 337008
- **Motor Size/Type** 172mm x 20mm, AC • **AMPS** 0.49 on High
- **RPM** 159 on High

AIRFLOW	POWER USAGE	AIRFLOW EFFICIENCY
5063	58	87
Cubic Ft. Per Minute on High	Watts on High (Excludes Lights)	Cubic Ft. Per Minute Per Watt

52"



Canfield™ 300117 BSS, DBK, MWH, NI, OBB, WH

SPECIFICATIONS

- **Finishes** – Brushed Stainless Steel Finish, Medium Oak/Dark Oak Blades – Distressed Black Finish, American Walnut/Dark Walnut Blades – Matte White Finish, Matte White/Weathered White Walnut Blades – Brushed Nickel Finish, Cherry/Walnut Blades
- **Oil Brushed Bronze™, Shadowed Walnut Blades (shown)** – White Finish, White Blades
- **Blades (5) Included** • 14° Pitch • 52" Sweep • Reversible • Wood
- **Downlight** N/A
- **Included Control** Pull Chain
- **Optional Controls** 371042MUL, 337001WH, 371082
- **Mounting Slope – Pitch** 30° or 7/12 • **Lead Wire** 78"
- **cUL Listed** Indoor • **Hanging Weight** 19.7 lbs.
- **Warranty** Limited Lifetime
- **Low Ceiling Adaptable** With Purchase of Flush Mount Accessory 337008
- **Motor Size/Type** 172mm x 20mm, AC • **AMPS** 0.54 on High • **RPM** 155 on High

AIRFLOW	POWER USAGE	AIRFLOW EFFICIENCY
4868 Cubic Ft. Per Minute on High	66 Watts on High (Excludes Lights)	74 Cubic Ft. Per Minute Per Watt

52"



Sutter Place Select 339211 AP, MWH, OBB, OZ, SNW

SPECIFICATIONS

- **Finishes** – Antique Pewter Finish, Light Cherry/Black Cherry Blades, Satin Etched Glass
- Matte White Finish, Matte White Blades, White Alabaster Glass
- Oil Brushed Bronze™ Finish, Walnut/Cherry Blades, Umber Alabaster Glass
- **Olde Bronze® Finish, Cherry/Walnut Blades, Umber Etched Glass (shown)**
- Satin Natural White Finish, Satin Natural White Blades, White Alabaster Glass
- **Blades (5) Included** • 12° Pitch • 52" Sweep • Reversible • Wood
- **Downlight** Removable. Uses (3) E-12 60-W B10 Lamps 4064CLR
- **Included Control** Pull Chain • **Optional Controls** 371042MUL, 337001WH, 371082 • **Mounting Slope – Pitch** 22° or 4/12
- **Lead Wire** 78" • **cUL Listed** Indoor • **Hanging Weight** 18.61 lbs.
- **Warranty** Limited Lifetime • **Low Ceiling Adaptable** Flush Mount Canopy Included • **Motor Size/Type** 153mm x 15mm, AC
- **AMPS** 0.42 on High • **RPM** 152 on High

AIR PERFORMANCE			AIR PERFORMANCE (FLUSH)		
AIRFLOW	POWER USAGE	AIRFLOW EFFICIENCY	AIRFLOW	POWER USAGE	AIRFLOW EFFICIENCY
3832 Cubic Ft. Per Minute on High	49 Watts on High (Excludes Lights)	79 Cubic Ft. Per Minute Per Watt	3469 Cubic Ft. Per Minute on High	49 Watts on High (Excludes Lights)	71 Cubic Ft. Per Minute Per Watt

52"



Sutter Place Premier 339400 AP, MWH, OBB, OZ

SPECIFICATIONS

- **Finishes** – Antique Pewter Finish, Light Cherry/Black Cherry Blades, Satin Etched Glass
- Matte White Finish, Matte White Blades, White Alabaster Glass
- Oil Brushed Bronze™ Finish, Walnut/Cherry Blades, Umber Alabaster Glass
- **Olde Bronze® Finish, Cherry/Walnut Blades, Umber Alabaster Glass (shown)**
- **Blades (5) Included** • 12° Pitch • 52" Sweep • Reversible • Wood
- **Downlight** Integrated. Uses (3) E-12 60-W B10 Lamps 4064CLR
- **Included Control** Pull Chain
- **Optional Controls** 371042MUL, 337001WH, 371082
- **Mounting Slope – Pitch** 22° or 4/12 • **Lead Wire** 78"
- **cUL Listed** Indoor • **Hanging Weight** 20 lbs. • **Warranty** Limited Lifetime • **Low Ceiling Adaptable** Flush Mount Canopy Included
- **Motor Size/Type** 153mm x 15mm, AC • **AMPS** 0.40 on High • **RPM** 154 on High

AIR PERFORMANCE			AIR PERFORMANCE (FLUSH)		
AIRFLOW	POWER USAGE	AIRFLOW EFFICIENCY	AIRFLOW	POWER USAGE	AIRFLOW EFFICIENCY
3915 Cubic Ft. Per Minute on High	48 Watts on High (Excludes Lights)	82 Cubic Ft. Per Minute Per Watt	3615 Cubic Ft. Per Minute on High	48 Watts on High (Excludes Lights)	75 Cubic Ft. Per Minute Per Watt

52"



Stratmoor 339022 OBB, WH

SPECIFICATIONS

- **Finishes** – Oil Brushed Bronze™ Finish, Walnut/Cherry Blades – **White Finish, White Blades (shown)**
- **Blades (5) Included** • 14° Pitch • 52" Sweep • Reversible • Wood
- **Downlight** N/A
- **Included Control** Pull Chain
- **Optional Controls** 371042MUL, 337001WH, 371082
- **Mounting Slope – Pitch** Flush Mount Only • **Lead Wire** 12"
- **cUL Listed** Indoor • **Hanging Weight** 14.4 lbs.
- **Warranty** Limited Lifetime
- **Low Ceiling Adaptable** Flush Mount
- **Motor Size/Type** 153mm x 15mm, AC • **AMPS** 0.48 on High • **RPM** 153 on High

AIRFLOW	POWER USAGE	AIRFLOW EFFICIENCY
2511 Cubic Ft. Per Minute on High	54 Watts on High (Excludes Lights)	46 Cubic Ft. Per Minute Per Watt

# Ceiling Fans

# Indoor

50"



Renew™ Select 330110 MWH, NI, OBB, TZ, WH

### SPECIFICATIONS

- **Finishes** – Matte White Finish, Matte White Blades, White Etched Glass  
– Brushed Nickel Finish, Cherry/Walnut Blades, White Etched Glass  
– **Oil Brushed Bronze® Finish, Cherry/Walnut Blades, White Etched Glass**  
– Tannery Bronze™ Finish, Dark Cherry/Teak Blades, Umber Etched Glass  
– White Finish, White Blades, White Etched Glass
- **Blades** (5) Included • 12° Pitch • 50" Sweep • Reversible • Wood
- **Downlight** Removable. Uses (3) E12 60-W B8 Lamps
- **Included Control** Pull Chain
- **Optional Controls** 371042MUL, 337001WH, 371082
- **Mounting Slope** – Pitch 22° or 7/12 • **Lead Wire** 78"
- **cUL Listed** Indoor • **Hanging Weight** 27.50 lbs.
- **Warranty** Limited Lifetime • **Low Ceiling Adaptable** Flush Mount Canopy Included • **Motor Size/Type** 153mm x 15mm, AC
- **AMPS** 0.60 on High • **RPM** 181 on High

#### AIR PERFORMANCE

AIRFLOW	POWER USAGE	AIRFLOW EFFICIENCY
4443	69	64
<small>Cubic Ft. Per Minute on High</small>	<small>Watts on High (Excludes Lights)</small>	<small>Cubic Ft. Per Minute Per Watt</small>

#### AIR PERFORMANCE (FLUSH)

AIRFLOW	POWER USAGE	AIRFLOW EFFICIENCY
4153	70	60
<small>Cubic Ft. Per Minute on High</small>	<small>Watts on High (Excludes Lights)</small>	<small>Cubic Ft. Per Minute Per Watt</small>

50"



Renew™ Premier CFL 339240 MWH, NI, OBB, TZ, WH

### SPECIFICATIONS

- **Finishes** – **Matte White Finish, Matte White Blades, White Etched Glass (shown)**  
– Brushed Nickel Finish, Cherry/Walnut Blades, White Etched Glass  
– Oil Brushed Bronze® Finish, Cherry/Walnut Blades, White Etched Glass  
– Oil Brushed Bronze® Finish, Cherry/Walnut Blades, Umber Etched Glass  
– Tannery Bronze™ Finish, Dark Cherry/Teak Blades, Umber Etched Glass  
– White Finish, White Blades, White Etched Glass
- **Blades** (5) Included • 12° Pitch • 50" Sweep • Reversible • Wood
- **Downlight** Integrated. Uses (4) E-26 13-W Non-Dimmable CFL Lamps 4052 • **Included Control** Pull Chain
- **Optional Controls** 371042MUL, 337001WH, 371082
- **Mounting Slope** – Pitch 22° or 4/12 • **Lead Wire** 78"
- **cUL Listed** Indoor • **Hanging Weight** 20.8 lbs.
- **Warranty** Limited Lifetime
- **Low Ceiling Adaptable** Flush Mount Canopy Included
- **Motor Size/Type** 153mm x 15mm, AC • **AMPS** 0.60 on High
- **RPM** 184 on High

#### AIR PERFORMANCE

AIRFLOW	POWER USAGE	AIRFLOW EFFICIENCY
4438	69	64
<small>Cubic Ft. Per Minute on High</small>	<small>Watts on High (Excludes Lights)</small>	<small>Cubic Ft. Per Minute Per Watt</small>

#### AIR PERFORMANCE (FLUSH)

AIRFLOW	POWER USAGE	AIRFLOW EFFICIENCY
4061	70	58
<small>Cubic Ft. Per Minute on High</small>	<small>Watts on High (Excludes Lights)</small>	<small>Cubic Ft. Per Minute Per Watt</small>

50"



Renew™ Select CFL 330103 NI, OBB, OBBU, WH

### SPECIFICATIONS

- **Finishes** – **Brushed Nickel Finish, Cherry/Walnut Blades, White Etched Glass (shown)**  
– Oil Brushed Bronze™ Finish, Walnut/Cherry Blades, White Etched Glass  
– Oil Brushed Bronze™ Finish, Walnut/Cherry Blades, Umber Etched Glass  
– White Finish, White Blades, White Etched Glass
- **Blades** (5) Included • 12° Pitch • 50" Sweep • Reversible • Wood
- **Downlight** Removable. Uses (2) E26 Medium Base 13-W Non-Dimmable CFL Lamps 4052 • **Included Control** Pull Chain
- **Optional Controls** 371042MUL, 337001WH, 371082
- **Mounting Slope** – Pitch 22° Pitch or 4/12 • **Lead Wire** 78"
- **cUL Listed** Indoor • **Hanging Weight** 27.5 lbs.
- **Warranty** Limited Lifetime
- **Low Ceiling Adaptable** Flush Mount Canopy Included
- **Motor Size/Type** 153mm x 15mm, AC • **AMPS** 0.58 on High
- **RPM** 210 on High

#### AIR PERFORMANCE

AIRFLOW	POWER USAGE	AIRFLOW EFFICIENCY
4657	67	69
<small>Cubic Ft. Per Minute on High</small>	<small>Watts on High (Excludes Lights)</small>	<small>Cubic Ft. Per Minute Per Watt</small>

#### AIR PERFORMANCE (FLUSH)

AIRFLOW	POWER USAGE	AIRFLOW EFFICIENCY
4421	68	65
<small>Cubic Ft. Per Minute on High</small>	<small>Watts on High (Excludes Lights)</small>	<small>Cubic Ft. Per Minute Per Watt</small>

50"



Renew™ 330100 NI, OBB, TZ, WH

### SPECIFICATIONS

- **Finishes** – **Brushed Nickel Finish, Walnut/Cherry Blades**  
– **Oil Brushed Bronze™ Finish, Walnut/Cherry Blades (shown)**  
– Tannery Bronze™ Finish, Dark Cherry/Teak Blades  
– White Finish, White Blades
- **Blades** (5) Included • 12° Pitch • 50" Sweep • Reversible • Wood
- **Downlight** N/A
- **Included Control** Pull Chain
- **Optional Controls** 371042MUL, 337001WH, 371082
- **Mounting Slope** – Pitch 22° or 4/12
- **Lead Wire** 78"
- **cUL Listed** Indoor
- **Hanging Weight** 25.3 lbs.
- **Warranty** Limited Lifetime
- **Low Ceiling Adaptable** Flush Mount Canopy Included
- **Motor Size/Type** 153mm x 15mm, AC
- **AMPS** 0.58 on High • **RPM** 210 on High

#### AIR PERFORMANCE

AIRFLOW	POWER USAGE	AIRFLOW EFFICIENCY
4596	66	69
<small>Cubic Ft. Per Minute on High</small>	<small>Watts on High (Excludes Lights)</small>	<small>Cubic Ft. Per Minute Per Watt</small>

#### AIR PERFORMANCE (FLUSH)

AIRFLOW	POWER USAGE	AIRFLOW EFFICIENCY
4417	67	66
<small>Cubic Ft. Per Minute on High</small>	<small>Watts on High (Excludes Lights)</small>	<small>Cubic Ft. Per Minute Per Watt</small>



52"



Basics Select 403 NI7, SNB, WH

SPECIFICATIONS

- **Finishes** – Brushed Nickel Finish, Cherry/Walnut Blades, White Etched Glass
- Satin Natural Bronze Finish, Dark Cherry/Teak Blades, White Etched Glass
- **White Finish, White Blades, White Etched Glass**
- **Blades** (5) Included • 12° Pitch • 52" Sweep • Reversible • Wood
- **Downlight** Removable. Uses (3) E-12 60-W B10 Lamps 4064CLR
- **Included Control** Pull Chain
- **Optional Controls** 371042MUL, 337001WH, 371082
- **Mounting Slope** – Pitch 30° or 7/12
- **Lead Wire** 78" • **cUL Listed** Indoor
- **Hanging Weight** 16.4 lbs.
- **Warranty** Limited Lifetime
- **Low Ceiling Adaptable** Flush Mount Canopy Included
- **Motor Size/Type** 153mm x 13mm, AC
- **AMPS** 0.51 on High • **RPM** 167 on High

AIR PERFORMANCE

AIRFLOW	POWER USAGE	AIRFLOW EFFICIENCY
3893	62	63
<small>Cubic Ft. Per Minute on High</small>	<small>Watts on High (Excludes Lights)</small>	<small>Cubic Ft. Per Minute Per Watt</small>

AIR PERFORMANCE (FLUSH)

AIRFLOW	POWER USAGE	AIRFLOW EFFICIENCY
3169	62	51
<small>Cubic Ft. Per Minute on High</small>	<small>Watts on High (Excludes Lights)</small>	<small>Cubic Ft. Per Minute Per Watt</small>

52"



Basics Premier 402 NI7, SNB, WH1

SPECIFICATIONS

- **Finishes** – Brushed Nickel Finish, Cherry/Walnut Blades, White Etched Glass
- **Satin Natural Bronze Finish, Dark Cherry/Teak Blades, White Etched Glass**
- White Finish, White Blades, White Etched Glass
- **Blades** (5) Included • 12° Pitch • 52" Sweep • Reversible • Wood
- **Downlight** Integrated. Uses (4) E-12 40-W B10 Lamps 4063CLR
- **Included Control** Pull Chain
- **Optional Controls** 371042MUL, 337001WH, 371082
- **Mounting Slope** – Pitch 30° or 7/12
- **Lead Wire** 78" • **cUL Listed** Indoor
- **Hanging Weight** 17.6 lbs.
- **Warranty** Limited Lifetime
- **Low Ceiling Adaptable** Flush Mount Canopy Included
- **Motor Size/Type** 153mm x 13mm, AC
- **AMPS** 0.50 on High
- **RPM** 160 on High

AIR PERFORMANCE

AIRFLOW	POWER USAGE	AIRFLOW EFFICIENCY
3863	57	66
<small>Cubic Ft. Per Minute on High</small>	<small>Watts on High (Excludes Lights)</small>	<small>Cubic Ft. Per Minute Per Watt</small>

AIR PERFORMANCE (FLUSH)

AIRFLOW	POWER USAGE	AIRFLOW EFFICIENCY
2954	57	52
<small>Cubic Ft. Per Minute on High</small>	<small>Watts on High (Excludes Lights)</small>	<small>Cubic Ft. Per Minute Per Watt</small>

52"



Basics 404 NI7, SNB, WH

SPECIFICATIONS

- **Finishes** – Brushed Nickel Finish, Cherry/Walnut Blades (shown)
- Satin Natural Bronze Finish, Dark Cherry/Teak Blades
- White Finish, White Blades
- **Blades** (5) Included • 12° Pitch • 52" Sweep • Reversible • Wood
- **Downlight** N/A
- **Included Control** Pull Chain
- **Optional Controls** 371042MUL, 337001WH, 371082
- **Mounting Slope** – Pitch 30° or 7/12
- **Lead Wire** 78"
- **cUL Listed** Indoor
- **Hanging Weight** 14 lbs.
- **Warranty** Limited Lifetime
- **Low Ceiling Adaptable** Flush Mount Canopy Included
- **Motor Size/Type** 153mm x 13mm, AC
- **AMPS** 0.49 on High
- **RPM** 186 on High

AIR PERFORMANCE

AIRFLOW	POWER USAGE	AIRFLOW EFFICIENCY
3778	57	66
<small>Cubic Ft. Per Minute on High</small>	<small>Watts on High (Excludes Lights)</small>	<small>Cubic Ft. Per Minute Per Watt</small>

AIR PERFORMANCE (FLUSH)

AIRFLOW	POWER USAGE	AIRFLOW EFFICIENCY
3065	60	51
<small>Cubic Ft. Per Minute on High</small>	<small>Watts on High (Excludes Lights)</small>	<small>Cubic Ft. Per Minute Per Watt</small>

# Ceiling Fans

# Indoor/Outdoor



**Tess 310220 OZ, WSP, WZC**

### SPECIFICATIONS

- **Finishes** – Olde Bronze® Finish, Cherry/Walnut Blades
- **Weathered Steel Finish, Teak/Walnut Blades (shown)**
- Weathered Zinc Finish, Dark Walnut/Weathered Walnut Blades
- **Blades (5)** Included • 13° Pitch • 52" Sweep • Reversible • ABS
- **Downlight** N/A
- **Included Control** Pull Chain
- **Optional Controls** 371042MUL, 337001WH, 371082
- **Mounting Slope – Pitch** 30° or 7/12 • **Lead Wire** 78"
- **cUL Listed** Wet • **Hanging Weight** 26.4 lbs.
- **Warranty** Limited Lifetime
- **Low Ceiling Adaptable** With Purchase of Flush Mount Accessory 337008
- **Motor Size/Type** 153mm x 18mm, AC
- **AMPS** 0.51 on High
- **RPM** 183 on High

AIRFLOW	POWER USAGE	AIRFLOW EFFICIENCY
5263	61	87
Cubic Ft. Per Minute on High	Watts on High (Excludes Lights)	Cubic Ft. Per Minute Per Watt



**Terna™ Patio LED 310215 TZP, WSP**

### SPECIFICATIONS

- **Finishes** – Tannery Bronze™ Finish, Oil Brushed Bronze™ Blades, Etched Cased Opal Glass
- **Weathered Steel Finish, Champagne Blades, Etched Cased Opal Glass (shown)**
- **Blades (5)** Included • Variable Pitch • 15" Sweep • Non-Reversible • Polycarbonate
- **Downlight** Integrated. 17-W Dimmable LED Platform 1,600 Lumens, 80 CRI, 3,000 CCT
- **Included Control** 3-Speed CoolTouch™ Full Function
- **Optional Controls** 370038MULTR
- **Mounting Slope – Pitch** 22° or 4/12
- **Lead Wire** 78"
- **cUL Listed** Damp • **Hanging Weight** 15.87 lbs.
- **Warranty** Limited Lifetime • **Low Ceiling Adaptable** N/A
- **Motor Size/Type** 153mm x 15mm, AC
- **AMPS** 0.28 on High • **RPM** 322 on High

AIRFLOW	POWER USAGE	AIRFLOW EFFICIENCY
351	33	11
Cubic Ft. Per Minute on High	Watts on High (Excludes Lights)	Cubic Ft. Per Minute Per Watt



**Monarch™ Patio 310206 MWH, WCP, WSP**

### SPECIFICATIONS

- **Finishes** – Matte White Finish, Weathered White Blades (shown)
- Weathered Copper Finish, Brown Blades
- Weathered Steel Finish, Weathered Walnut Blades
- **Blades (5)** Included • 16° Pitch • 70" Sweep • Non-Reversible • ABS
- **Downlight** N/A
- **Included Control** Wall Control System – Full Function
- **Optional Controls** 337009WHTR
- **Mounting Slope – Pitch** 30° or 7/12
- **Lead Wire** 78"
- **cUL Listed** Wet • **Hanging Weight** 30.80 lbs.
- **Warranty** Limited Lifetime
- **Low Ceiling Adaptable** N/A
- **Motor Size/Type** 212mm x 25mm, AC • **AMPS** 0.78 on High
- **RPM** 122 on High

AIRFLOW	POWER USAGE	AIRFLOW EFFICIENCY
8339	94	89
Cubic Ft. Per Minute on High	Watts on High (Excludes Lights)	Cubic Ft. Per Minute Per Watt



60"



**Canfield™ XL Patio 310193 TZP, WSP**

**SPECIFICATIONS**

- **Finishes** – Tannery Bronze™ Finish, Cherry/Walnut Blades (shown) – Weathered Steel Finish, Walnut/Teak Blades
- **Blades** (5) Included • 14" Pitch • 60" Sweep • Reversible • ABS
- **Downlight** N/A
- **Included Control** Pull Chain
- **Optional Controls** 371042MUL, 371082
- **Mounting Slope** – Pitch 30° or 7/12
- **Lead Wire** 78"
- **cUL Listed** Wet • **Hanging Weight** 29.81 lbs.
- **Warranty** Limited Lifetime
- **Low Ceiling Adaptable** With Purchase of Flush Mount Accessory 337008
- **Motor Size/Type** 212mm x 25mm, AC
- **AMPS** 0.68 on High
- **RPM** 167 on High

AIRFLOW	POWER USAGE	AIRFLOW EFFICIENCY
6678 Cubic Ft. Per Minute on High	81 Watts on High (Excludes Lights)	82 Cubic Ft. Per Minute Per Watt

52"



**Canfield™ Patio 310192 SBK, TZP, WCP, WH, WSP**

**SPECIFICATIONS**

- **Finishes** – Satin Black Finish, Satin Black Blades – Tannery Bronze™ Finish, Cherry/Walnut Blades – Weathered Copper Finish, Cherry/Walnut Blades – White Finish, White/Weathered White Walnut Blades – **Weathered Steel Finish, Walnut/Teak Blades (shown)**
- **Blades** (5) Included • 14" Pitch • 52" Sweep • Reversible • ABS
- **Downlight** N/A
- **Included Control** Pull Chain
- **Optional Controls** 371042MUL, 371082, 3W500
- **Mounting Slope** – Pitch 30° or 7/12 • **Lead Wire** 78"
- **cUL Listed** Wet • **Hanging Weight** 24.20 lbs.
- **Warranty** Limited Lifetime
- **Low Ceiling Adaptable** With Purchase of Flush Mount Accessory 337008
- **Motor Size/Type** 172mm x 20mm, AC • **AMPS** 0.59 on High
- **RPM** 185 on High

AIRFLOW	POWER USAGE	AIRFLOW EFFICIENCY
5481 Cubic Ft. Per Minute on High	71 Watts on High (Excludes Lights)	78 Cubic Ft. Per Minute Per Watt

52"



**Renew™ Patio 339515 SBK, TZP, WH**

**SPECIFICATIONS**

- **Finishes** – Satin Black Finish, Satin Natural Black Blades – **Tannery Bronze™ Finish, Brown Blades (shown)** – White Finish, White Blades
- **Blades** (5) Included • 12" Pitch • 52" Sweep • Non-Reversible • ABS
- **Downlight** N/A
- **Included Control** Pull Chain
- **Optional Controls** 371042MUL, 371082
- **Mounting Slope** – Pitch 22° or 4/12
- **Lead Wire** 78"
- **cUL Listed** Wet • **Hanging Weight** 23.10 lbs.
- **Warranty** Limited Lifetime
- **Low Ceiling Adaptable** Flush Mount Accessory Included
- **Motor Size/Type** 153mm x 15mm, AC
- **AMPS** 0.57 on High
- **RPM** 202 on High

AIRFLOW	POWER USAGE	AIRFLOW EFFICIENCY
4870 Cubic Ft. Per Minute on High	67 Watts on High (Excludes Lights)	73 Cubic Ft. Per Minute Per Watt

52"



**Basics™ Patio 401 NI, SBK, SNB, WH**

**SPECIFICATIONS**

- **Finishes** – **Brushed Nickel Finish, Brown Blades (shown)** – Satin Natural Black Finish, Satin Natural Black Blades – Satin Natural Bronze Finish, Brown Blades – White Finish, White Blades
- **Blades** (5) Included • 12" Pitch • 52" Sweep • Non-Reversible • ABS
- **Downlight** N/A
- **Included Control** Pull Chain
- **Optional Controls** 371042MUL, 371082
- **Mounting Slope** – Pitch 30° or 7/12
- **Lead Wire** 78"
- **cUL Listed** Damp • **Hanging Weight** 15.63 lbs.
- **Warranty** Limited Lifetime
- **Low Ceiling Adaptable** Flush Mount Canopy Included
- **Motor Size/Type** 153mm x 13mm, AC • **AMPS** 0.48 on High
- **RPM** 178 on High

AIRFLOW	POWER USAGE	AIRFLOW EFFICIENCY
4286 Cubic Ft. Per Minute on High	56 Watts on High (Excludes Lights)	75 Cubic Ft. Per Minute Per Watt



## Accessories



### 371085 CoolTouch™ Control System – Full Function

- Designed for AC motor fans
- Includes transmitter and canopy-mounted receiver
- Learn mode canopy receiver with **65,000 code settings** included
- 3 forward speeds, reverse and motor off
- Lights on/off with full range dimming or on/off only for fluorescent
- Dims LED light sources
- Down light control: on/off plus full range dimming or on/off only for fluorescent
- Wireless radio frequency operation, radius of 30 feet or less
- Retrofits most pull chain fans
- Replaces any single wall switch or mounts on any flat surface
- Receiver designed for wet locations
- Includes wall bracket and all mounting hardware
- Includes replaceable, long-life lithium batteries
- Includes white, ivory & almond switch and cover plates
- U.S. and Canadian patent pending



### 371082 CoolTouch™ Control System – Basic

- Designed for AC motor fans
- Includes transmitter and canopy-mounted receiver
- Learn mode canopy receiver with **65,000 code settings** included
- 3 forward speeds and motor off
- Dims LED light sources
- Manual reverse
- Down light control: on/off plus full range dimming or on/off only for fluorescent
- Wireless radio frequency operation, radius of 30 feet or less
- Retrofits most pull chain fans
- Replaces any single wall switch or mounts on any flat surface
- Receiver designed for wet locations
- Includes wall bracket and all mounting hardware
- Includes replaceable, long-life lithium batteries
- Includes white, ivory & almond switch and cover plates
- U.S. and Canadian patent pending



### 371045 MUL Wall Control System – Full Function

- Designed for AC Fans
- Includes Transmitter and Canopy mounted receiver
- Learn mode canopy receiver with 65,000 code settings included
- 3 Forward speeds, reverse and motor off
- Lights On/Off with full range dimming; Dims LED
- Includes white, ivory & almond switch and cover plates
- Transmitter to be placed indoors
- Hard wired wall control



### 371042 MUL Wall Control System – Basic

- Designed for AC Fans
- Includes Transmitter and Canopy mounted receiver
- Learn mode canopy receiver with 65,000 code settings included
- 3 Forward speeds and motor off
- Manual Reverse
- Lights On/Off with full range dimming; Dims LED
- Includes white, ivory & almond switch and cover plates
- Transmitter to be placed indoors
- Hard wired wall control



## Outdoor Lighting

**LED** page 132

**LED Options** page 137

**Fluorescent/Incandescent** page 139

**Commercial Outdoor** page 162

Incorporating the right outdoor lighting can make a property approachable and inviting while also adding efficiencies to both utility costs and maintenance. Kichler Lighting Outdoor Fixtures are built to perform with sturdy construction and time-tested finishes that stand up to the elements. We offer an array of styles, many with an integrated LED or LED bulb solution for years of quality light output.

For an expanded selection of Outdoor fixtures, visit [Kichler.com](http://Kichler.com)



## Kichler Lighting Outdoor fixtures are a reliable source of light, style and durability

Integrated LEDs deliver excellent light distribution and energy savings for 40,000 hours (to L70, or 70% initial lumens)

Durable materials and finishes, including our Climates™ collections, are quality tested to withstand the elements

Dark Sky certified options work to accommodate projects in which light pollution is a concern

Polycarbonate



**A** 49802 BKTLED, PLLED

Polycarbonate



**B** 49803 BKTLED, PLLED

White Glass



**C** 49557 AZLED

White Glass



**D** 49558 AZLED

Etched Glass



**E** 49278 AZTLED, PLLED

Etched Glass



**F** 49279 AZTLED, PLLED

	LED ITEM #	FINISH	LIGHT SOURCE	LED FIXTURE OUTPUT	DIMENSIONS	EXT.	HCWO	NOTES
A	49802	BKTLED, PLLED	(1) 25W	3000K, 90 CRI, 375 Lumens, 15 LPW	8.25W x 19H	4	9.5	Dimmable.
B	49803	BKTLED, PLLED	(1) 25W	3000K, 90 CRI, 475 Lumens, 19 LPW	9.5W x 24H	4	12	Dimmable.
C	49557	AZLED	(2) 40W	3000K, 90 CRI, 650 Lumens, 16 LPW	8W x 18.75H	4	10	Dimmable.
D	49558	AZLED	(2) 60W	3000K, 90 CRI, 875 Lumens, 15 LPW	8W x 25.25H	4	13.25	Dimmable.
E	49278	AZTLED, PLLED	(1) 8W	3000K, 90 CRI, 790 Lumens, 99 LPW	7W x 7.5H	4	3.75	Dimmable.
F	49279	AZTLED, PLLED	(2) 16W	3000K, 90 CRI, 1580 Lumens, 99 LPW	7W x 14H	4	7	Dimmable.

Measurements shown in inches. U.S. Patent Pending.



	LED ITEM #	FINISH	LIGHT SOURCE	LED FIXTURE OUTPUT	DIMENSIONS	EXT.	HCWO	NOTES
G	49607	AZTLED	(1) 8W	3000K, 90 CRI, 790 Lumens, 99 LPW	6W x 12H	4.25	6	Dimmable.
H	49608	AZTLED	(2) 8W	3000K, 90 CRI, 1580 Lumens, 99 LPW	6W x 16.5H	4.25	8.25	Dimmable.
I	11309	BKTLED	(1) 10W	3000K, 90 CRI, 500 Lumens, 50 LPW	5W x 7H	6.5	3.50	Dimmable.
J	11310	BKTLED	(2) 10W	3000K, 90 CRI, 950 Lumens, 48 LPW	5W x 12.25H	6.5	6.25	Dimmable.
K	11251	AZT30, BKT30	(1) 15W	3000K, 90 CRI, 550 Lumens, 33 LPW	5W x 12H	6.5	6.25	
L	11250	AZT30, BKT30	(1) 11W	3000K, 90 CRI, 350 Lumens, 33 LPW	5W x 7H	6.5	3.25	
M	11077	AZT, BKT	(1) 15W	3000K, 80 CRI, 400 Lumens, 27 LPW	5W x 5.5H	6	2.75	
N	49550	AZLED, BKTLED	(1) 8W	3000K, 90 CRI, 790 Lumens, 99 LPW	5W x 7.25H	3.75	3.75	Dimmable.
O	49551	AZLED, BKTLED	(2) 16W	3000K, 90 CRI, 1580 Lumens, 99 LPW	5W x 12H	3.75	6	Dimmable.

Measurements shown in inches. U.S. Patent Pending.

# Outdoor LED

White Glass



**A** | 49785 BKLED

White Glass



**B** | 49786 BKLED

Clear Architectural Glass



**C** | 49117 AZLED

Clear Architectural Glass



**D** | 49118 AZLED

Clear Architectural Glass



**E** | 49190 AZLED

Clear Polycarbonate



**F** | 49492 AZ, PL, SBK

Clear Polycarbonate



**G** | 49434 AZ, PL, SBK

Clear Polycarbonate



**H** | 49435 AZ, PL, SBK

LED ITEM #	FINISH	LIGHT SOURCE	LED FIXTURE OUTPUT	DIMENSIONS	EXT.	HCWO	NOTES
A	49785 BKLED	(2) 30W	3000K, 90 CRI, 450 Lumens, 15 LPW	7W x 16.25H	4.5	8	Dimmable.
B	49786 BKLED	(2) 50W	3000K, 90 CRI, 650 Lumens, 13 LPW	9W x 20.75H	4.5	10.5	Dimmable.
C	49117 AZLED	(1) 8W	3000K, 90 CRI, 750 Lumens, 99 LPW	5.25W x 10.75H	5.5	5.5	Dimmable.
D	49118 AZLED	(1) 8W	3000K, 90 CRI, 790 Lumens, 99 LPW	6.5W x 16H	5.75	8	Dimmable.
E	49190 AZLED	(2) 16W	3000K, 90 CRI, 1580 Lumens, 99 LPW	10.75W x 16H	5.75	8	Dimmable.
F	49492 AZ, PL, SBK	(1) 16W	3000K, 80 CRI, 450 Lumens, 28 LPW	6W x 12.25H	4	6.25	
G	49434 AZ, PL, SBK	(1) 30W	3000K, 80 CRI, 800 Lumens, 27 LPW	6W x 18.25H	4	9.25	
H	49435 AZ, PL, SBK	(1) 30W	3000K, 80 CRI, 825 Lumens, 28 LPW	6W x 24.25H	4	12.25	

Measurements shown in inches. U.S. Patent Pending.

= ADA Compliant = DAMP = WET = Dark Sky Compliant = LED Integrated = Lamp Included = CFL Lamp Included = LED Bulb Included



Clear Polycarbonate



I | 49436 AZ

Clear Polycarbonate



J | 49437 AZ

White Polycarbonate



K | 11320 BKTLED

White Polycarbonate



L | 11131 AZTLED

White Polycarbonate



M | 11132 AZTLED

White Polycarbonate



N | 11134 AZTLED

White Polycarbonate



O | 11135 AZTLED

LED ITEM #	FINISH	LIGHT SOURCE	LED FIXTURE OUTPUT	DIMENSIONS	EXT.	HCWO	NOTES
I	49436 AZ	(1) 25W	3000K, 80 CRI, 550 Lumens, 22 LPW	6W x 18H	4.75	9	
J	49437 AZ	(1) 30W	3000K, 80 CRI, 775 Lumens, 26 LPW	6W x 24H	4.75	12	
K	11320 BKTLED	(1) 16W	3000K, 90 CRI, 875 Lumens, 55 LPW	10W x 13H	5.25	7	Dimmable.
L	11131 AZTLED	(1) 15W	3000K, 90 CRI, 840 Lumens, 56 LPW	9W x 2.75H	2.75	4.5	Dimmable. May be installed on wall or ceiling.
M	11132 AZTLED	(1) 23W	3000K, 90 CRI, 1220 Lumens, 53 LPW	11W x 3H	3	5.5	Dimmable. May be installed on wall or ceiling.
N	11134 AZTLED	(1) 15W	3000K, 90 CRI, 740 Lumens, 49 LPW	9W x 3.25H	3.25	4.5	Dimmable. May be installed on wall or ceiling.
O	11135 AZTLED	(1) 23W	3000K, 90 CRI, 1060 Lumens, 46 LPW	11W x 3.5H	3.5	5.5	Dimmable. May be installed on wall or ceiling.

Measurements shown in inches. U.S. Patent Pending.



Etched Seeded Glass



A | 49623 BKTLED

Etched Seeded Glass



B | 49622 BKTLED

Etched Seeded Glass



C | 49624 BKTLED

Etched Seeded Glass



D | 49625 BKTLED

Clear Seeded Glass



E | 9707 OZLED

Clear Seeded Glass



F | 9708 OZLED

Clear Seeded Glass



G | 9709 OZLED

Clear Seeded Glass



H | 9909 OZLED

For fixtures with LED,  
Energy Star® rated  
light bulbs included,

Look for "L18" in the model number



LED ITEM #	FINISH	LIGHT SOURCE	LED FIXTURE OUTPUT	DIMENSIONS	EXT.	HCWO	NOTES
A	49623	BKTLED	(1) 17W  3000K, 90 CRI, 875 Lumens, 51 LPW	7.5W x 15H	8.5	3.75	Dimmable.
B	49622	BKTLED	(1) 17W  3000K, 90 CRI, 800 Lumens, 47 LPW	6.5W x 13H	7.5	3.75	Dimmable.
C	49624	BKTLED	(1) 17W  3000K, 90 CRI, 875 Lumens, 51 LPW	8.75W x 17.25H	10	3.75	Dimmable.
D	49625	BKTLED	(1) 17W  3000K, 90 CRI, 850 Lumens, 50 LPW	8.5W x 19.75H	---	---	Dimmable. Shown with post 9506 BK.
E	9707	OZLED	(1) 8W  3000K, 90 CRI, 790 Lumens, 99 LPW	5.5W x 12.5H	6.25	5.5	Dimmable.
F	9708	OZLED	(1) 8W  3000K, 90 CRI, 790 Lumens, 99 LPW	7.5W x 16.75H	8.25	6.75	Dimmable.
G	9709	OZLED	(1) 8W  3000K, 90 CRI, 790 Lumens, 99 LPW	9.5W x 19.5H	10.25	7.25	Dimmable.
H	9909	OZLED	(1) 8W  3000K, 90 CRI, 790 Lumens, 99 LPW	9.5W x 20.75H	---	---	Dimmable. Shown with post 9506 OZ.

Measurements shown in inches. U.S. Patent Pending.





# LED Options

Clear Beveled Glass



I | 49183 BK, TZ  
49183 BKL18, TZL18

Clear Beveled Glass



J | 49186 BK, TZ  
49186 BKL18, TZL18

Clear Beveled Glass



K | 9794 BK, TZ  
9794 BKL18, TZL18

Clear Beveled Glass



L | 49187 BK, TZ  
49187 BKL18, TZL18

Clear Beveled Glass



M | 9935 BK, TZ  
9935 BKL18, TZL18

Satin Etched Glass



N | 49686 OZ

Satin Etched Glass



O | 49687 OZ

Satin Etched Glass



P | 49688 OZ

Satin Etched Glass



Q | 49690 OZ

ITEM #	FINISH	LIGHT SOURCE	LED BULB OUTPUT	DIMENSIONS	EXT.	HCWO	NOTES
I	49183 BK, TZ	(1) 100W (M)	---	6.25W x 10.25H	6.5	1.75	Ⓜ
I	49183 BKL18, TZL18	(1) 10W (M)	3000K, 92 CRI, 800 Lumens, 80 LPW	6.25W x 10.25H	6.5	1.75	Ⓜ Dimmable.
J	49186 BK, TZ	(1) 100W (M)	---	9.75W x 18.75H	9.5	7.75	Ⓜ
J	49186 BKL18, TZL18	(1) 10W (M)	3000K, 92 CRI, 800 Lumens, 80 LPW	9.75W x 18.75H	9.5	7.75	Ⓜ Dimmable.
K	9794 BK, TZ	(1) 100W (M)	---	4.75W x 8.5H	5.75	2.5	Ⓜ
K	9794 BKL18, TZL18	(1) 10W (M)	3000K, 92 CRI, 800 Lumens, 80 LPW	4.75W x 8.5H	5.75	2.5	Ⓜ Dimmable.
L	49187 BK, TZ	(1) 100W (M)	---	9.75W x 18H	---	---	Ⓜ Shown with post 9510 BK.
L	49187 BKL18, TZL18	(1) 10W (M)	3000K, 92 CRI, 800 Lumens, 80 LPW	9.75W x 18H	---	---	Ⓜ Dimmable.
M	9935 BK, TZ	(1) 100W (M)	---	8W x 16H	---	---	Ⓜ Shown with post 9506 BK.
M	9935 BKL18, TZL18	(1) 10W (M)	3000K, 92 CRI, 800 Lumens, 80 LPW	8W x 16H	---	---	Ⓜ Dimmable. Shown with post 9506 BK.
N	49686 OZ	(1) 75W (M)	---	6W x 10.25H	6.5	2.75	Ⓜ
O	49687 OZ	(1) 100W (M)	---	8W x 13.5H	8.75	3.75	Ⓜ
P	49688 OZ	(1) 150W (M)	---	10W x 20H	11	4.25	Ⓜ
Q	49690 OZ	(1) 150W (M)	---	10W x 22H	---	---	Ⓜ Shown with post 9506 BK.

Measurements shown in inches. U.S. Patent Pending.



With breadth of style comes breadth of incandescent bulb choice.

Satin Etched Cased Opal Glass



A | 49475 RZ

Satin Etched Cased Opal Glass



B | 49476 RZ

Clear Hammered Glass - CLIMATES™



C | 49829 OZ

Clear Hammered Glass - CLIMATES™



D | 49830 OZ

Clear Hammered Glass - CLIMATES™



E | 49831 OZ

Clear Hammered Glass - CLIMATES™



F | 49832 OZ

Clear Hammered Glass - CLIMATES™



G | 49834 OZ

## CLIMATES™ Outdoor Lighting

Uses a composite material with UV protectant to create an anti-fading finish that's resistant to: acidic and alkali elements, corrosion and rust.

	ITEM #	FINISH	LIGHT SOURCE	DIMENSIONS	EXT.	HCWO	NOTES
A	49475	RZ	(1) 60W (M)	7W x 17.75H	7.75	9.5	Ⓜ T type bulb recommended.
B	49476	RZ	(1) 100W (M)	9W x 19.75H	9.5	---	Ⓜ Variable hgt. mounting hardware inc. Height from center junction box 10"-13.25".
C	49829	OZ	(1) 75W (M)	6.5W x 12H	7.5	2.5	Ⓜ Ⓞ
D	49830	OZ	(1) 100W (M)	8W x 14.25H	9	2.5	Ⓜ Ⓞ
E	49831	OZ	(1) 150W (M)	9.5W x 17.5H	10.5	2.5	Ⓜ Ⓞ
F	49832	OZ	(1) 150W (M)	9.5W x 20.5H	---	---	Ⓜ Ⓞ Shown with post 9506 BK.
G	49834	OZ	(2) 75W (M) ❖	12W x 5.25H	---	---	Ⓜ Ⓞ

Measurements shown in inches. U.S. Patent Pending.

Ⓞ - CLIMATES™ - Resistant against rust, corrosion and fading

Ⓜ = WET

# Outdoor | Wall, Post & Ceiling

Clear Water Glass



A | 49924 BKT

Clear Water Glass



B | 49925 BKT

Clear Water Glass



C | 49926 BKT

Clear Water Glass



D | 49927 BKT

Clear Seeded Glass - CLIMATES™



E | 49857 BKT

Clear Seeded Glass - CLIMATES™



F | 49858 BKT

Clear Seeded Glass - CLIMATES™



G | 49859 BKT

Clear Seeded Glass - CLIMATES™



H | 49860 BKT

Clear Seeded Glass - CLIMATES™



I | 49861 BKT

	ITEM #	FINISH	LIGHT SOURCE	DIMENSIONS	EXT.	HCWO	NOTES
A	49924	BKT	(1) 60W (M)	6.5W x 10.25H	7.75	2	W
B	49925	BKT	(1) 75W (M)	8.5W x 13.25H	10	2.25	W
C	49926	BKT	(1) 100W (M)	10.5W x 16H	12	2.25	W
D	49927	BKT	(1) 100W (M)	10.5W x 18.25H	---	---	W Shown with post 9506 BK.
E	49857	BKT	(1) 75W (M)	5.5W x 11.25H	6.75	2.5	W C
F	49858	BKT	(1) 100W (M)	7.75W x 15.5H	9	3	W C
G	49859	BKT	(1) 150W (M)	9W x 17.5H	10.25	3.5	W C
H	49860	BKT	(1) 150W (M)	9W x 20H	---	---	W C Shown with post 9506 BK.
I	49861	BKT	(1) 75W (M) ❖	5.5W x 11H	---	---	D C

**C** - CLIMATES™ - Resistant against rust, corrosion and fading

**♿** = ADA Compliant **D** = DAMP **W** = WET **☾** = Dark Sky Compliant **⚙️** = LED Integrated **💡** = Lamp Included **🔌** = CFL Lamp Included **🔦** = LED Bulb Included

Clear Seeded Glass



J | 49960 AVI

Clear Seeded Glass



K | 49961 AVI

Clear Seeded Glass



L | 49962 AVI

Clear Seeded Glass



M | 49963 AVI

Clear Seeded Glass



N | 49965 AVI

Clear Seeded Glass



O | 49820 BKT

Clear Seeded Glass



P | 49821 BKT

Clear Seeded Glass



Q | 49822 BKT

Clear Seeded Glass



R | 49823 BKT

	ITEM #	FINISH	LIGHT SOURCE	DIMENSIONS	EXT.	HCWO	NOTES
J	49960	AVI	(1) 75W (M)	5.5W x 10.25H	7	3	W
K	49961	AVI	(1) 100W (M)	7W x 16H	9	6.5	W
L	49962	AVI	(1) 150W (M)	9W x 21H	12	8.5	W
M	49963	AVI	(1) 150W (M)	9W x 22.5H	---	---	W Shown with post 9506 BK.
N	49965	AVI	(2) 60W (M) ❖	12.25W x 6H	---	---	D
O	49820	BKT	(1) 75W (M)	6W x 10.5H	7.25	2.75	W
P	49821	BKT	(1) 100W (M)	8W x 14.5H	9.25	3.25	W
Q	49822	BKT	(1) 150W (M)	10W x 18.25H	11.25	3.25	W
R	49823	BKT	(3) 60W (C)	10W x 23.5H	---	---	W Shown with post 9506 BK.

Measurements shown in inches. U.S. Patent Pending.

- CLIMATES™ - Resistant against rust, corrosion and fading

# Outdoor | Wall, Post & Ceiling

Clear Seeded Glass



**A** 49497 AZ, BA

Clear Seeded Glass



**B** 49444 AZ, BA

Clear Seeded Glass



**C** 49445 AZ, BA

Clear Seeded Glass



**D** 49496 AZ, BA

Clear Seeded Glass



**E** 49882 DBK

Clear Seeded Glass



**F** 49883 DBK

Clear Seeded Glass



**G** 49884 DBK

Clear Seeded Glass



**H** 49885 DBK



**I** 49837 BK

ITEM #	FINISH	LIGHT SOURCE	DIMENSIONS	EXT.	HCWO	NOTES
A	AZ, BA	(1) 100W (M)	10W x 20H	---	---	Ⓜ Shown with post 9506 BK.
B	AZ, BA	(1) 75W (M)	5W x 11.25H	7.5	3.75	Ⓜ
C	AZ, BA	(1) 100W (M)	6W x 15H	8	5	Ⓜ
D	AZ, BA	(2) 60W (C)	8W x 18.25H	9.5	5	Ⓜ
E	DBK	(1) 60W (M)	5.25W x 11H	8	4.25	Ⓜ
F	DBK	(1) 75W (M)	7W x 14.75H	10.75	5.75	Ⓜ
G	DBK	(1) 100W (M)	9W x 19H	13.75	7.25	Ⓜ
H	DBK	(3) 60W (C)	9W x 20.25H	---	---	Ⓜ Shown with post 9506 BK.
I	BK	(1) 150W (M)	10.25W x 19H	16	13	Ⓜ For this style in a smaller size, see item 49836 BK.

Measurements shown in inches.

= ADA Compliant 
 = DAMP 
 = WET 
 = Dark Sky Compliant 
 = LED Integrated 
 = Lamp Included 
 = CFL Lamp Included 
 = LED Bulb Included

Satin Etched Glass



J | 49824 BK

Satin Etched Glass



K | 49825 BK

Satin Etched Glass



L | 49826 BK

Satin Etched Glass



M | 49827 BK



N | 49991 GG, WH



O | 49993 WH, GG

CLIMATES™



P | 49980 BKT

CLIMATES™



Q | 49981 BKT

CLIMATES™



R | 49982 BKT

	ITEM #	FINISH	LIGHT SOURCE	DIMENSIONS	OVERALL H	EXTRA WIRE	CHAIN/STEM	EXT.	HCWO	NOTES
J	49824	BK	(1) 75W (M)	7W x 9.5H	---	---	---	8.25	2.25	W
K	49825	BK	(1) 100W (M)	9W x 13.25H	---	---	---	10.25	2.5	W
L	49826	BK	(1) 150W (M)	11W x 16.25H	---	---	---	12.25	2.5	W
M	49827	BK	(1) 150W (M)	9W x 23.25H	---	---	---	---	---	W Shown with post 9506 BK.
N	49991	GG, WH	(1) 150W (M)	16.5W x 16.25H	---	---	---	23.25	7.25	W For this style in a smaller size, see item 49990 GG, WH.
O	49993	GG, WH	(1) 150W (M)	16.5W x 11H	49	73	36	---	---	D For this style in a smaller size, see item 49992 GG, WH. Sloped ceiling kit included.
P	49980	BKT	(1) 100W (M)	12W x 9H	---	---	---	17.25	4.25	W G
Q	49981	BKT	(1) 150W (M)	14W x 9H	---	---	---	20	4.25	W G
R	49982	BKT	(1) 100W (M)	12W x 7H	45	72	36	---	---	D G Additional stem 4935 BKT.

# Outdoor | Wall, Post & Ceiling



A | 49775 BA, BK



B | 49776 BA, BK



C | 2621 NI



D | 9021 BK, NI, OZ



E | 9142 BK, NI, OZ



F | 9022 BK, NI, OB, OZ, WH



G | 9023 BK, NI, OB, OZ



H | 2713 NI, OB



I | 9044 NI

ITEM #	FINISH	LIGHT SOURCE	DIMENSIONS	OVERALL H	STEM TILT	EXTRA WIRE	CHAIN/STEM	EXT.	HCWO	NOTES
A	49775 BA, BK	(1) 100W (M)	10W x 12H	---	---	---	---	17.25	3	W
B	49776 BA, BK	(1) 150W (M)	14W x 16.75H	---	---	---	---	24	4	W
C	2621 NI	(1) 100W (M)	8W x 9.75H	48	45	68	36	---	---	D Additional Stem 2997,2999, 3036, 3048NI
D	9021 BK, NI, OZ	(1) 60W (M)	6W x 7.5H	---	---	---	---	6.5	2.25	W
E	9142 BK, NI, OZ	(1) 150W (M)	12W x 16.5H	---	---	---	---	13.5	10.25	W
F	9022 BK, NI, OB, OZ, WH	(1) 100W (M)	8W x 12H	---	---	---	---	9	6	W
G	9023 BK, NI, OB, OZ	(1) 150W (M)	10.25W x 14.25H	---	---	---	---	11.75	9	W May be ☾ if A-19 or R-30 bulbs are used.
H	2713 NI, OB	(1) 150W (M)	16W x 13.25H	88	---	36	72	---	---	D Additional chain 2996 NI, 4927 OB.
I	9044 NI	(1) 150W (M)	11W x 8H	---	---	---	---	11.5	5.5	W

= ADA Compliant 
 = DAMP 
 = WET 
 = Dark Sky Compliant 
 = LED Integrated 
 = Lamp Included 
 = CFL Lamp Included 
 = LED Bulb Included



Etched Seeded Glass



J | 49917 BK

Etched Seeded Glass



K | 49918 BK

Etched Seeded Glass



L | 49919 BK

Etched Seeded Glass



M | 49920 BK

Clear Seeded Glass



N | 49892 OZ

Clear Seeded Glass



O | 49893 OZ

Clear Seeded Glass



P | 49894 OZ

Clear Seeded Glass



Q | 49895 OZ

ITEM #	FINISH	LIGHT SOURCE	DIMENSIONS	EXT.	HCWO	NOTES
J	49917 BK	(1) 60W (M)	6W x 12.25H	7.75	3.75	Ⓢ
K	49918 BK	(1) 75W (M)	8W x 15.75H	10.25	3.75	Ⓢ
L	49919 BK	(1) 100W (M)	9.5W x 18.5H	12	3.75	Ⓢ
M	49920 BK	(1) 100W (M)	9.5W x 20.5H	---	---	Ⓢ Shown with post 9506 BK.
N	49892 OZ	(1) 60W (M)	6W x 11H	7	3.5	Ⓢ
O	49893 OZ	(1) 75W (M)	7.5W x 14.5H	8.75	4.5	Ⓢ
P	49894 OZ	(1) 100W (M)	9W x 17.25H	10.25	4.5	Ⓢ
Q	49895 OZ	(1) 100W (M)	9W x 19.25H	---	---	Ⓢ Shown with post 9506 BK.

Measurements shown in inches.

Clear Seeded Glass



A | 9032 BKT, RZ

Clear Seeded Glass



B | 9033 BKT, RZ

Clear Seeded Glass



C | 9034 BKT, RZ

Clear Seeded Glass



D | 9035 BKT, RZ

Clear Seeded Glass



E | 9532 BKT, RZ

Clear Seeded Glass



F | 9533 BKT, RZ

Clear Seeded Glass



G | 9538 BKT, RZ

ITEM #	FINISH	LIGHT SOURCE	DIMENSIONS	EXT.	HCWO	NOTES
A	9032 BKT, RZ	(1) 100W (M)	6.25W x 11H	7	3.5	W
B	9033 BKT, RZ	(1) 150W (M)	8.25W x 17.75H	11	7.75	W
C	9034 BKT, RZ	(3) 60W (C)	10.25W x 22.25H	13.5	9	W
D	9035 BKT, RZ	(3) 60W (C)	12.25W x 26.5H	16.5	12.5	W
E	9532 BKT, RZ	(1) 200W (M)	10.25W x 23.75H	---	---	W Shown with post 9506 BK.
F	9533 BKT, RZ	(3) 60W (C)	12.25W x 27H	---	---	W Shown with post 9506 BK.
G	9538 BKT, RZ	(3) 40W (C) ✓	12.25W x 6.25H	---	---	D

Measurements shown in inches.

Clear Seeded Glass



H | 49840 OZ

Clear Seeded Glass



I | 49841 OZ

Clear Seeded Glass



J | 49842 OZ

Clear Seeded Glass



K | 49843 OZ

Clear Seeded Glass



L | 49844 OZ

Satin Etched Glass



M | 49654 BK

Satin Etched Glass



N | 49655 BK

Satin Etched Glass



O | 49656 BK

Satin Etched Glass



P | 49657 BK

	ITEM #	FINISH	LIGHT SOURCE	DIMENSIONS	OVERALL H	EXTRA WIRE	CHAIN/STEM	EXT.	HCWO	NOTES
H	49840	OZ	(1) 75W (M)	5.75W x 10.25H	---	---	---	6.75	3.5	W
I	49841	OZ	(1) 100W (M)	7.5W x 13.5H	---	---	---	8.5	4.5	W
J	49842	OZ	(1) 150W (M)	9.5W x 17H	---	---	---	10.5	4.5	W
K	49843	OZ	(1) 150W (M)	9.5W x 19.75H	---	---	---	---	---	W Shown with post 9506 BK.
L	49844	OZ	(1) 150W (M)	9.5W x 18.75H	93	29	72	---	---	D Additional chain 4927 OZ.
M	49654	BK	(1) 100W (M)	6W x 11H	---	---	---	7.25	3.5	W
N	49655	BK	(1) 100W (M)	8W x 14.25H	---	---	---	9.25	3.5	W
O	49656	BK	(1) 100W (M)	9.5W x 17.25H	---	---	---	10.75	4.5	W
P	49657	BK	(1) 100W (M)	9.5W x 20.5H	---	---	---	---	---	W Shown with post 9506 BK.

Measurements shown in inches.

# Outdoor | Wall, Post & Ceiling

White Linen Glass



A | 9039 BK, RZ

White Linen Glass



B | 9040 BK, RZ

White Linen Glass



C | 9041 BK, RZ

White Linen Glass



D | 9042 BK, RZ

White Linen Glass



E | 9043 BK, RZ

White Linen Glass



F | 9848 BK, RZ

White Linen Glass



G | 9938 BK, RZ

White Linen Glass



H | 9940 BK, RZ

ITEM #	FINISH	LIGHT SOURCE	DIMENSIONS	EXT.	HCWO	NOTES
A	9039 BK, RZ	(1) 60W (M)	6W x 10.25H	7.25	4.5	W
B	9040 BK, RZ	(1) 100W (M)	8W x 19.5H	10.75	6.75	W
C	9041 BK, RZ	(1) 100W (M)	8W x 19.25H	10.75	9.75	W
D	9042 BK, RZ	(1) 150W (M)	10W x 24.25H	13.25	12.5	W
E	9043 BK, RZ	(1) 200W (M)	12W x 29H	16.25	14.25	W
F	9848 BK, RZ	(2) 60W (M)	13.5W x 7.5H	---	---	D
G	9938 BK, RZ	(1) 150W (M)	10W x 21.75H	---	---	W Shown with post 9506 BK.
H	9940 BK, RZ	(1) 200W (M)	12W x 25.5H	---	---	W Shown with post 9506 BK.

Measurements shown in inches.

= ADA Compliant 
 = DAMP 
 = WET 
 = Dark Sky Compliant 
 = LED Integrated 
 = Lamp Included 
 = CFL Lamp Included 
 = LED Bulb Included

BK, TZ, WH: Clear Beveled Glass  
BKS: Satin Etched Glass



I | 49255 BK, BKS, TZ, WH

BK, WH: Clear Beveled Glass  
BKS: Satin Etched Glass



J | 49256 BK, BKS, WH

BK, WH: Clear Beveled Glass  
BKS: Satin Etched Glass



K | 9774 BK, BKS, WH

BK, WH: Clear Beveled Glass  
BKS: Satin Etched Glass



L | 9776 BK, BKS, WH

Clear Beveled Glass



M | 9777 BK, WH

Clear Beveled Glass



N | 9735 BK, TZ

Clear Beveled Glass



O | 9736 BK, TZ

ITEM #	FINISH	LIGHT SOURCE	DIMENSIONS	EXT.	HCWO	NOTES
I	49255 BK, BKS, TZ, WH	(1) 100W (M)	6.5W x 17H	7.75	14	Ⓜ
J	49256 BK, BKS, WH	(1) 100W (M)	6.5W x 18H	---	---	Ⓜ
K	9774 BK, BKS, WH	(1) 60W (M)	5.5W x 10.25H	6.25	2.25	Ⓜ
L	9776 BK, BKS, WH	(1) 100W (M)	6.5W x 11.75H	8	3.25	Ⓜ
M	9777 BK, WH	(3) 60W (C)	7.25W x 14.75H	8.5	3	Ⓜ
N	9735 BK, TZ	(1) 100W (M)	8W x 15.5H	8	6.25	Ⓜ
O	9736 BK, TZ	(1) 100W (M)	8W x 21.75H	8	15	Ⓜ

Measurements shown in inches.

# Outdoor | Wall, Post & Ceiling

Clear Seeded Glass



A | 9028 BK, TZ

Clear Seeded Glass



B | 9029 BK, TZ

Clear Seeded Glass



C | 9030 BK, TZ

Clear Seeded Glass



D | 9918 BK, TZ

Clear Beveled Glass



E | 9783 OZ

Clear Beveled Glass



F | 9784 OZ

Clear Beveled Glass



G | 9785 OZ

Clear Beveled Glass



H | 9985 OZ

ITEM #	FINISH	LIGHT SOURCE	DIMENSIONS	EXT.	HCWO	NOTES
A	9028 BK, TZ	(1) 100W (M)	6.5W x 13H	7.5	8	W
B	9029 BK, TZ	(1) 150W (M)	8.5W x 17H	9.5	10.25	W
C	9030 BK, TZ	(3) 60W (C)	9.75W x 21H	11.5	13	W
D	9918 BK, TZ	(3) 60W (C)	9.75W x 23.5H	---	---	W
E	9783 OZ	(1) 100W (M)	7W x 10.75H	7	4	W
F	9784 OZ	(1) 100W (M)	8.25W x 14.75H	8	5.5	W
G	9785 OZ	(3) 60W (C)	10.5W x 21H	9.75	8.25	W
H	9985 OZ	(3) 60W (C)	10.5W x 20.75H	---	---	W Shown with post 9506 BK.

Measurements shown in inches.

= ADA Compliant 
 = DAMP 
 = WET 
 = Dark Sky Compliant 
 = LED Integrated 
 = Lamp Included 
 = CFL Lamp Included 
 = LED Bulb Included

Clear Beveled Glass



I | 9788 BK, TZ

Clear Beveled Glass



J | 9789 BK, TZ

Clear Beveled Glass



K | 9790 BK, TZ

Clear Beveled Glass



L | 9791 BK, TZ

Clear Beveled Glass



M | 9992 BK, TZ

Clear Beveled Glass



N | 49185 BK, TZ

ITEM #	FINISH	LIGHT SOURCE	DIMENSIONS	EXT.	HCWO	NOTES
I	9788 BK, TZ	(1) 100W (M)	6.5W x 11.75H	6.5	2.75	Ⓜ
J	9789 BK, TZ	(1) 100W (M)	7.25W x 15.25H	9	4.5	Ⓜ
K	9790 BK, TZ	(1) 100W (M)	7.25W x 21.5H	9.75	15.75	Ⓜ
L	9791 BK, TZ	(1) 100W (M)	9.25W x 26.75H	10.25	21	Ⓜ
M	9992 BK, TZ	(1) 100W (M)	9.25W x 24H	---	---	Ⓜ Shown with post 9506 BK.
N	49185 BK, TZ	(3) 60W (C)	12.25W x 31H	12.25	23.5	Ⓜ

Measurements shown in inches.

# Outdoor | Wall, Post & Ceiling

Clear Beveled Glass



A | 9650 BK, TZ, WH

Clear Beveled Glass



B | 9653 BK, TZ, WH

Clear Beveled Glass



C | 9654 BK, TZ, WH

Clear Beveled Glass



D | 9655 BK, TZ

Clear Beveled Glass



E | 9956 BK, TZ

Umber Linen Glass



F | 10954 TZ

Clear Beveled Glass



G | 9618 OZ

Satin Etched Glass



H | 10923 BK, TZ

ITEM #	FINISH	LIGHT SOURCE	DIMENSIONS	EXT.	HCWO	NOTES
A	9650 BK, TZ, WH	(1) 100W (M)	8W x 14.75H	8.5	4.25	W
B	9653 BK, TZ, WH	(1) 100W (M)	8W x 19.75H	8.5	15.5	W
C	9654 BK, TZ, WH	(1) 150W (M)	9.5W x 22.75H	10	16.5	W
D	9655 BK, TZ	(1) 100W (M)	9.25W x 17H	10.25	6.5	W
E	9956 BK, TZ	(1) 150W (M)	9.5W x 21.5H	---	---	W Shown with post 9506 BK.
F	10954 TZ	(1) 13W (GU24) ⚡	9.25W x 17H	10.25	6.5	W
G	9618 OZ	(1) 100W (M)	5.75W x 10H	6.25	3.25	W
H	10923 BK, TZ	(1) 13W (GU24) ⚡	4.75W x 9.5H	5.75	2.5	W



Clear Beveled Glass



J | 9618 SS

Clear Glass



K | 9611 BK, OZ, SS, TZ, WH

Clear Beveled Glass



L | 9886 BK, TZ

Textured Clear Glass



M | 365 BK

Textured Clear Glass



N | 345 BK, TZ

Frosted Glass



O | 9322 BK, WH

Frosted Glass



P | 9320 BK, WH

Clear Seeded Glass



Q | 9859 BK, TZ

Clear Beveled Glass



R | 9850 BK, TZ

	ITEM #	FINISH	LIGHT SOURCE	DIMENSIONS	EXT.	HCWO	NOTES
J	9618	SS	(1) 100W (M)	5.75W x 10H	6.25	3.25	Ⓜ
K	9611	BK, OZ, SS, TZ, WH	(1) 60W (M)	5W x 8.25H	5.75	5.25	Ⓜ
L	9886	BK, TZ	(2) 40W (C) ❖	12W x 7H	---	---	Ⓜ
M	365	BK	(1) 60W (M) ❖	7.5W x 5H	---	---	Ⓜ
N	345	BK, TZ	(2) 60W (M) ❖	9.25W x 5.25H	---	---	Ⓜ
O	9322	BK, WH	(2) 60W (M) ✓	10.5W x 5.5H	---	---	Ⓜ
P	9320	BK, WH	(1) 60W (M)	8.5W x 5H	---	---	Ⓜ
Q	9859	BK, TZ	(1) 100W (M) ✓	7.25W x 7.25H	---	---	Ⓜ
R	9850	BK, TZ	(2) 60W (C) ❖	10.75W x 7.25H	---	---	Ⓜ

Measurements shown in inches.

# Outdoor Wall



**A** | 9234 AZ, BA, BK, WH



**B** | 9236 AZ



**C** | 9244 AZ, BA, BK, WH



**D** | 9246 AZ, BA, BK, WH

Smoked Umber Diffuser



**E** | 9095 AZ

White Acrylic Diffuser



**F** | 6040 AZ, NI

White Acrylic Diffuser



**G** | 6048 AZ, NI



**H** | 6052 AZ, WH

Clear Glass



**I** | 1148 BK, TZ, WH

	ITEM #	FINISH	LIGHT SOURCE	DIMENSIONS	EXT.	HCWO	NOTES
A	9234	AZ, BA, BK, WH	(1) 65W (M)	4.75W x 7H	7	3.5	W ☾
B	9236	AZ	(1) 120W (M)	6W x 7.75H	8.5	4	W ☾
C	9244	AZ, BA, BK, WH	(2) 65W (M)	4.5W x 12H	7	6	D
D	9246	AZ, BA, BK, WH	(2) 120W (M)	6W x 15H	8.5	7.5	D
E	9095	AZ	(1) 100W (M)	7W x 12H	5.5	6	W ☾
F	6040	AZ, NI	(1) 30W (M)	9.25W x 10.25H	3.75	5.5	W ☾
G	6048	AZ, NI	(2) 30W (M)	9.25W x 15.25H	3.75	7.75	W ☾
H	6052	AZ, WH	(2) 150W (M)	6W x 11.25H	---	10.5	W Wall or ceiling mountable. Single light version (6051AZ,WH) also available.
I	1148	BK, TZ, WH	(1) 75W (M)	4.5W x 7.5H	5.5	2.25	W

= ADA Compliant 
 = DAMP 
 = WET 
 = Dark Sky Compliant 
 = LED Integrated 
 = Lamp Included 
 = CFL Lamp Included 
 = LED Bulb Included



# Address Lights – LED & Xenon



A | 43800 BKT Xenon Address Light



B | 43800 BKTLED LED Address Light



C | 4301 #1 Block



D | 4302 #2 Block



E | 4303 #3 Block



F | 4304 #4 Block



G | 4305 #5 Block



H | 4306 #6 Block



I | 4307 #7 Block



J | 4308 #8 Block



K | 4309 #9 Block



L | 4300 #0 Block



M | 4310 Blank Block



N | 4311 2 Blank Half Blocks

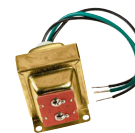

O | 4381 Transformer



P | 4355 CLR

	ITEM #	FINISH	LIGHT SOURCE	LED FIXTURE OUTPUT	W	H	L	EXT.	HCWO	NOTES
A	43800	BKT	(2) 5W (WED5)		2.5	7	12.25	2.5	3.5	Cast Aluminum Construction.
B	43800	BKTLED	(1) 4W	3000K, 80 CRI	2.5	7	12.25	2.5	3.5	Cast Aluminum Construction.
C-N	4301 – 4311	---	---		2.25	5	0.25	---	---	
O	4381	---	---		2.75	5	2	---	---	Optional: Necessary only when doorbell transformer unavailable for installation. 16V output.
P	4355	CLR	(1) 5W (WED5)		0.5	1	---	---	---	Replacement bulb for Xenon fixture

Measurements shown in inches.  
\*Initial Lumens. Visit Kichler.com for recent performance and certification data.

Integrated LED – 120V-277V



A | 16231 AZT



B | 16234 AZT



C | 16235 AZT



D | 16236 AZT



E | 16237 AZT



F | 16238 AZT

ITEM #	FINISH	CCT*	VOLTAGE RANGE	LIGHT SOURCE	LED FIXTURE OUTPUT**	DIMENSIONS	NOTES
A	16231	AZT	30 / 40 / 50	120V-277V	19W	>70 CRI, 1750-2400 Lumens 95-130 LPW	8.62W x 7.60H x 6.00D DLC, 10'-12' Mt. Ht., COB LED replaces the equivalent of a 70W HID.
B	16234	AZT	30 / 40 / 50	120V-277V	20W	>70 CRI, 1950-2225 Lumens 98-111 LPW	6.22W x 5.50H x 13.90D DLC, 8'-10' Mt. Ht., LED Array replaces the equivalent of a 70W HID.
C	16235	AZT	30 / 40 / 50	120V-277V	39W	>70 CRI, 3650-4250 Lumens 94-109 LPW	6.22W x 5.50H x 13.90D DLC, 10'-12' Mt. Ht., LED Array replaces the equivalent of a 100W HID, Does not work with photocell.
D	16236	AZT	30 / 40 / 50	120V-277V	10W	>80 CRI, 900-1150 Lumens 90-115 LPW	7.08W x 9.09H x 3.93D DLC, 8'-10' Mt. Ht., COB LED replaces the equivalent of a 50W HID, Can mount as uplight with Trunnion 16292AZT.
E	16237	AZT	30 / 40 / 50	120V-277V	18W	>70 CRI, 1775-2225 Lumens 99-124 LPW	7.08W x 9.09H x 3.93D DLC, 10'-12' Mt. Ht., COB LED replaces the equivalent of a 100W HID, Can mount as uplight with Trunnion 16292AZT.
F	16238	AZT	30 / 40 / 50	120V-277V	38W	>70 CRI, 3400-4000 Lumens 91-107 LPW	7.08W x 9.09H x 3.93D DLC, 14'-16' Mt. Ht., COB LED replaces the equivalent of a 200W HID, Can mount as uplight with Trunnion 16292AZT.

As we continue to add new models and color temperatures to this line, be sure to visit [Kichler.com/CSeries](http://Kichler.com/CSeries) for the most up to date assortment and specs.

\*Choose from 3000K (30), 4000K (40) and 5000K (50) where noted. To form a complete model ID, combine Item # + Finish + CCT, like 16231AZT30 (3000K small wall pack).

\*\*Data varies per CCT – see Kichler.com for Spec Sheets.



G | 16243 AZT



H | 16244 AZT



I | 16251 WHT



J | 16255 AZT

## Get performance you can depend on with Kichler Lighting's C-Series Ceiling and Wall fixtures.

Kichler Lighting's commercial-grade offering – the C-Series – was designed specifically for the rigorous demands of commercial outdoor lighting. Our expanded line of 120-277V LED fixtures can outfit robust outdoor installation plans – from overhead lighting for security or navigation, to enhancing the visual appeal of a property with landscape fixtures. Each fixture is designed with Kichler's attention to quality and value, delivering dependable operation, rugged die cast aluminum housings and a durable polyester powder coat finish that stands up to environmental demands.

### These additions to the C-Series line boast:

- Durable die cast aluminum housings
- Tamper resistant hardware
- Built-in surge protection up to 4kV
- Gaskets and fully potted drivers for water ingress protection

ITEM #	FINISH	CCT*	VOLTAGE RANGE	LIGHT SOURCE	LED FIXTURE OUTPUT**	DIMENSIONS	NOTES
G	16243 AZT	30 / 40 / 50	120V-277V	38W	>70 CRI, 3450-4575 Lumens 91-120 LPW	10.29W x 3.90H x 10.29D	DLC, 12'-15' Mt. Ht., COB LED replaces the equivalent of a 100W HID
H	16244 AZT	30 / 40 / 50	120V-277V	54W	>70 CRI, 5750-6525 Lumens 106-121 LPW	10.29W x 3.90H x 10.29D	DLC, 15'-18' Mt. Ht., COB LED replaces the equivalent of a 100-150W HID
I	16251 WHT	50	120V	21W	>80 CRI, 1900 Lumens 93 LPW	10.43W x 6.22H x 6.79D	DLC, 10'-13' Mt. Ht., LED Array, Built-in Photocell, Dual Sensor: Front 240°, Bottom 360°
J	16255 AZT	50	120V	21W	>80 CRI, 1900 Lumens 93 LPW	10.43W x 6.22H x 6.79D	DLC, 10'-13' Mt. Ht., LED Array, Built-in Photocell, Dual Sensor: Front 240°, Bottom 360°

### Accessories:

- 16245BK** Photocell
- 16256AZT** Junction box for 16236-38 photocell installation
- 16292AZT** Trunnion Mount for 16236-38 up-lighting installation



The C-Series Ceiling and Wall Fixtures are currently on the DLC QPL – meeting a high-performance set of standards established for output, efficacy, CCT, CRI and Warranty.

For the most current listing, visit [DesignLights.org](http://DesignLights.org)

# Line Voltage Lighting

**C-Series 120V-277V Integrated LED** page 162

**120V Integrated LED & Retrofit** page 168

**120V LED Lamps** page 173

**120V Accessories** page 174

For more than 25 years we've made it our commitment to continually offer one of the most comprehensive professional landscape lighting lines in the industry: from commercial-grade 120V-277V pieces that live up to harsh environmental wear and tear, to a full low-voltage line that's built for design flexibility, efficiency and performance. With Kichler Lighting fixtures, you can elevate the visual appeal of your property with a landscape lighting effect that's both inviting and functional for years to come.

For FREE, fast layout design and technical support, our Advanced Product Solution team can help: [Kichler.com/APS](http://Kichler.com/APS).





# C-Series: 120V-277V LED Commercial Outdoor Lighting that lives up to the Kichler Lighting name – and your reputation.

## Accent & Flood Lighting

### Center-to-edge optics

C-Series Accents and Floods offer center-to-edge optics for precise and uniform beam spread with no artifacts. In addition, each fixture is designed with 3-step binning to deliver a consistent color from fixture to fixture.

### Potted driver

is fully potted to protect against water ingress, which ensures long-lasting performance.

### Plugged knuckle cavity with strain relief

and internal cord grip system prevents movement to reinforce a secure connection at the source.

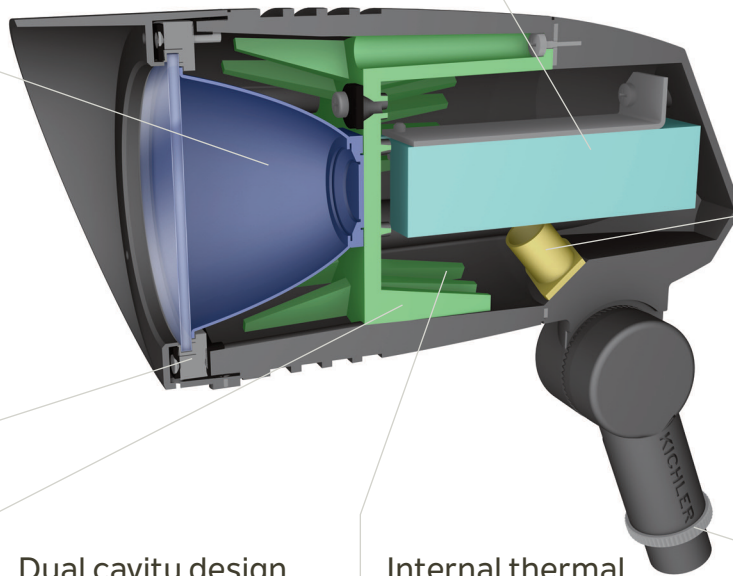

For warranty details visit [Kichler.com/Warranty](http://Kichler.com/Warranty)

**Multi-layer front lens seal** ensures a moisture-resistant seal.

**Dual cavity design** with cast aluminum housing divided into two independent compartments to protect the optical chamber and the LED from the operating heat of the driver.

**Internal thermal management** happens with internal cast heat sinking to repel heat from the driver to maximize lifetime and performance.

**Machined threads and lock nuts** for simple installations and adjustability.

**Durable knuckle** with deep grooved teeth for stronger engagement that is less likely to wear down.



**Built-in draining** designed to prevent water from pooling on the face of the fixture.

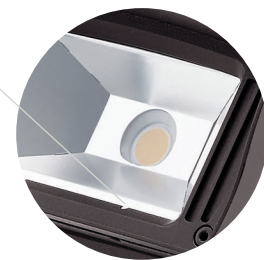





# The sturdy design of the Kichler Lighting C-Series line delivers years of quality light performance.

## Exceptionally Engineered

The C-Series line provides 120V-277V universal voltage from one fixture and contains built-in surge protection (4kV). The durable knuckle features clean-cut, deep ridges for a stronger engagement and comes equipped with vandal-resistant hardware for extended durability. And, our sleek designs feature die-cast, all-metal housings finished with a polyester powder coating that stands up to environmental demands.

## Designed for Performance

Our C-Series LED fixtures feature the latest in LED technology with center-to-edge optics for a precise beam spread that is uniform and crisp. Our 3-step binning process also assures the color you choose – 3000K or 4000K – is consistent from fixture to fixture.



Sleek and coordinating designs



Thick-gauge, cast metal housings



Textured powder coat finish



Center-to-edge optics



Many Kichler® C-Series fixtures appear on the DesignLights Consortium (DLC) qualified list of products. Visit [DesignLights.org](http://DesignLights.org) for a complete listing.

## These integrated fixtures come in a variety of beam spreads.

**Accent:** Use the 15-degree beam spread for tall, thin applications, 40-degree for medium height and width elements, and 55-degree for short, wide beams on broad structures or trees.

**Flood:** Integrated fixtures come in NEMA 6x5 beam (Small), NEMA 7x5 (Medium), and NEMA 7x6 beam (Large). See pages 164-166 for more details.



15°  
Beam Spread



33°/40°  
Beam Spread

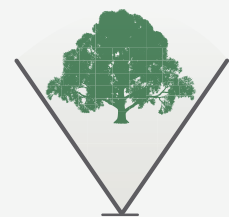

55°  
Beam Spread

Integrated LED – 120V-277V



	Small Accent – 5W		Small Accent – 10W	
Finishes	AZT (shown), BKT		BKT (shown), AZT	
Color Temperature	3000K - Pure White	4000K - Cool White	3000K - Pure White	4000K - Cool White
Item Number by Beam Spread and Finish	<b>15° Beam Spread</b> 16209 AZT30 16209 BKT30	<b>15° Beam Spread</b> 16209 AZT40 16209 BKT40	<b>15° Beam Spread</b> 16212 AZT30 16212 BKT30	<b>15° Beam Spread</b> 16212 AZT40* 16212 BKT40*
	<b>40° Beam Spread</b> 16210 AZT30 16210 BKT30	<b>40° Beam Spread</b> 16210 AZT40 16210 BKT40	<b>40° Beam Spread</b> 16213 AZT30 16213 BKT30	<b>40° Beam Spread</b> 16213 AZT40* 16213 BKT40*
	<b>55° Beam Spread</b> 16211 AZT30 16211 BKT30	<b>55° Beam Spread</b> 16211 AZT40 16211 BKT40	<b>55° Beam Spread</b> 16214 AZT30 16214 BKT30	<b>55° Beam Spread</b> 16214 AZT40* 16214 BKT40*
Housing	Cast Aluminum		Cast Aluminum	
Wattage/pf, Delivered Lumens & Efficacy	5W, .9pf 473-478 lm, 91-93 lm/W	5W, .9pf 495-514 lm, 93-100 lm/W	10W, .9pf 807-831 lm, 82-84 lm/W	10W, .9pf 914-942 lm, 91 lm/W
CRI	80+		80+	
Voltage Range	120V-277V, 50-60Hz. Surge protection up to 4kV.			
Light Source	1 integrated high-output LED with 3-step binning for color consistency. Custom reflector optics. Tested to a Lumen Maintenance L70 of 60,000 hrs.			
Notes	Replaces the equivalent of a 35W Halogen. Comes with 3 gel-filled wire nuts. IP66 rated. Vandal-proof hardware installed.		Replaces the equivalent of a 50W Halogen. Comes with 3 gel-filled wire nuts. IP66 rated. Vandal-proof hardware installed.	
Accessories	<b>15276</b> Power Post® <b>15601</b> Surface Mounting Flange <b>15609</b> Junction Box Mounting Bracket <b>15645, 15656, 15657, 15658</b> Stems		<b>16280</b> Long Visor/Cowl <b>16282</b> Hexcell Louver <b>16284</b> Frosted Lens <b>16286</b> Amber Lens <b>16288</b> Green Lens	
Dimensions				



	Large Accent – 14W		Large Accent – 21W	
Finishes	AZT (shown), BKT		BKT (shown), AZT	
Color Temperature	3000K - Pure White	4000K - Cool White	3000K - Pure White	4000K - Cool White
Item Number by Beam Spread and Finish	<b>15° Beam Spread</b> 16215 AZT30* 16215 BKT30*	<b>15° Beam Spread</b> 16215 AZT40* 16215 BKT40*	<b>15° Beam Spread</b> 16218 AZT30* 16218 BKT30*	<b>15° Beam Spread</b> 16218 AZT40* 16218 BKT40*
	<b>33° Beam Spread</b> 16216 AZT30* 16216 BKT30*	<b>33° Beam Spread</b> 16216 AZT40* 16216 BKT40*	<b>33° Beam Spread</b> 16219 AZT30* 16219 BKT30*	<b>33° Beam Spread</b> 16219 AZT40* 16219 BKT40*
	<b>55° Beam Spread</b> 16217 AZT30* 16217 BKT30*	<b>55° Beam Spread</b> 16217 AZT40* 16217 BKT40*	<b>55° Beam Spread</b> 16220 AZT30* 16220 BKT30*	<b>55° Beam Spread</b> 16220 AZT40* 16220 BKT40*
Housing	Cast Aluminum		Cast Aluminum	
Wattage/pf, Delivered Lumens & Efficacy	14W, .9pf 1263-1326 lm 90-92 lm/W	14W, .9pf 1347-1424 lm 96-102 lm/W	21W, .9pf 1889-2033 lm 89-97 lm/W	21W, .9pf 1950-2111 lm 93-99 lm/W
CRI	80+		80+	
Voltage Range	120V-277V, 50-60Hz. Surge protection up to 4kV.			
Light Source	1 integrated high-output LED with 3-step binning for color consistency. Custom reflector optics. Tested to a Lumen Maintenance L70 of 60,000 hrs.			
Notes	Replaces the equivalent of a 90W Halogen. Comes with 3 gel-filled wire nuts. IP66 rated. Vandal-proof hardware installed.		Replaces the equivalent of a 35W Metal Halide. Comes with 3 gel-filled wire nuts. IP66 rated. Vandal-proof hardware installed.	
Accessories	<b>15276</b> Power Post® <b>15601</b> Surface Mounting Flange <b>15609</b> Junction Box Mounting Bracket <b>15645, 15656, 15657, 15658</b> Stems		<b>16281</b> Long Visor/Cowl <b>16283</b> Hexcell Louver <b>16285</b> Frosted Lens <b>16287</b> Amber Lens <b>16289</b> Green Lens	
Dimensions				

Integrated LED – 120V-277V



	Small Flood – 12W		Small Flood – 23W	
Finishes	AZT (shown), BKT		BKT (shown), AZT	
Color Temperature	3000K - Pure White	4000K - Cool White	3000K - Pure White	4000K - Cool White
Item Number by Mounting Type and Finish	<b>Knuckle Mount:</b> 16221 AZT30* 16221 BKT30*	<b>Knuckle Mount:</b> 16221 AZT40* 16221 BKT40*	<b>Knuckle Mount:</b> 16222 AZT30 16222 BKT30	<b>Knuckle Mount:</b> 16222 AZT40 16222 BKT40
	<b>Trunnion Mount:</b> 16221 AZT30TR* 16221 BKT30TR*	<b>Trunnion Mount:</b> 16221 AZT40TR* 16221 BKT40TR*	<b>Trunnion Mount:</b> 16222 AZT30TR 16222 BKT30TR	<b>Trunnion Mount:</b> 16222 AZT40TR 16222 BKT40TR
	<b>Slip-Fit Mount:</b> 16221 AZT30SL* 16221 BKT30SL*	<b>Slip-Fit Mount:</b> 16221 AZT40SL* 16221 BKT40SL*	<b>Slip-Fit Mount:</b> 16222 AZT30SL 16222 BKT30SL	<b>Slip-Fit Mount:</b> 16222 AZT40SL 16222 BKT40SL
Housing	Cast Aluminum		Cast Aluminum	
Wattage/pf, Delivered Lumens & Efficacy	12W, .9pf 1119 lm, 89 lm/W	12W, .9pf 1210 lm, 100 lm/W	23W, .9pf 2049 lm, 86 lm/W	23W, .9pf 2082 lm, 89 lm/W
CRI	80+		80+	
Voltage Range	120V-277V, 50-60Hz. Surge protection up to 4kV			
Light Source	1 integrated high-output LED with 3-step binning for color consistency. Custom reflector optics. Tested to a Lumen Maintenance L70 of 60,000 hrs.			
Notes	Replaces the equivalent of a 75W Halogen. Comes with 3 gel-filled wire nuts. IP66 rated. Vandal proof hardware installed.		Replaces the equivalent of a 35W Metal Halide. Comes with 3 gel-filled wire nuts. IP66 rated. Vandal proof hardware installed.	
Accessories	<b>15276</b> Power Post® <b>15601</b> Surface Mounting Flange <b>15609</b> Junction Box Mounting Bracket <b>15645, 15656, 15657, 15658</b> Stems			
Dimensions				



	Medium Flood – 33W		Medium Flood – 50W	
Finishes	AZT (shown), BKT		BKT (shown), AZT	
Color Temperature	3000K - Pure White	4000K - Cool White	3000K - Pure White	4000K - Cool White
Item Number by Mounting Type and Finish	<b>Knuckle Mount:</b> 16223 AZT30* 16223 BKT30*	<b>Knuckle Mount:</b> 16223 AZT40* 16223 BKT40*	<b>Knuckle Mount:</b> 16224 AZT30* 16224 BKT30*	<b>Knuckle Mount:</b> 16224 AZT40* 16224 BKT40*
	<b>Trunnion Mount:</b> 16223 AZT30TR* 16223 BKT30TR*	<b>Trunnion Mount:</b> 16223 AZT40TR* 16223 BKT40TR*	<b>Trunnion Mount:</b> 16224 AZT30TR* 16224 BKT30TR*	<b>Trunnion Mount:</b> 16224 AZT40TR* 16224 BKT40TR*
	<b>Slip-Fit Mount:</b> 16223 AZT30SL* 16223 BKT30SL*	<b>Slip-Fit Mount:</b> 16223 AZT40SL* 16223 BKT40SL*	<b>Slip-Fit Mount:</b> 16224 AZT30SL* 16224 BKT30SL*	<b>Slip-Fit Mount:</b> 16224 AZT40SL* 16224 BKT40SL*
Housing	Cast Aluminum		Cast Aluminum	
Wattage/pf, Delivered Lumens & Efficacy	33W, .9pf 3287 lm, 99 lm/W	33W, .9pf 3495 lm, 104 lm/W	50W, .9pf 4496 lm, 89 lm/W	50W, .9pf 4795 lm, 94 lm/W
CRI	80+		80+	
Voltage Range	120V-277V, 50-60Hz. Surge protection up to 4kV		120V-277V, 50-60Hz. Surge protection up to 4kV	
Light Source	2 integrated high-output LEDs with 3-step binning for color consistency. Custom reflector optics. Tested to a Lumen Maintenance L70 of 60,000 hrs.			
Notes	Replaces the equivalent of a 70W Metal Halide. Comes with 3 gel-filled wire nuts. IP66 rated. Vandal proof hardware installed.		Replaces the equivalent of a 100W Metal Halide. Comes with 3 gel-filled wire nuts. IP66 rated. Vandal proof hardware installed.	
Accessories	<b>15276</b> Power Post® <b>15601</b> Surface Mounting Flange <b>15609</b> Junction Box Mounting Bracket <b>15656, 15657, 15658</b> Stems			

Dimensions

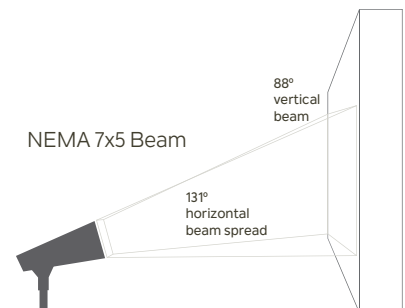
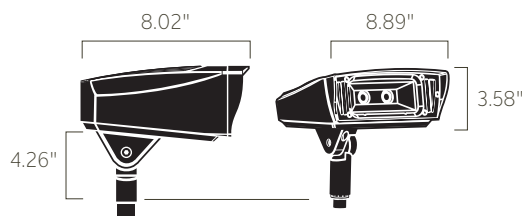

Integrated LED – 120V-277V



**Knuckle Mount**  
1/2" NPSM trade size fittings



**Trunnion Mount (TR)**  
Surface mount for variety of different mounting options.



**Slip-Fit Mount (SL)**  
2" trade size for post mount

## Large Flood – 85W

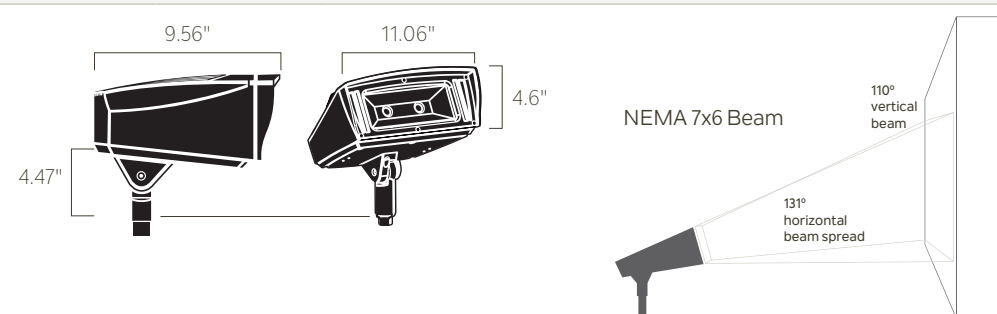
Finishes	AZT (shown), BKT		Additional Finishes
Color Temperature	3000K - Pure White	4000K - Cool White	 <b>BKT</b>
Item Number by Mounting Type and Finish	<b>Knuckle Mount:</b> 16225 AZT30 16225 BKT30	<b>Knuckle Mount:</b> 16225 AZT40* 16225 BKT40*	
	<b>Trunnion Mount:</b> 16225 AZT30TR 16225 BKT30TR	<b>Trunnion Mount:</b> 16225 AZT40TR* 16225 BKT40TR*	
	<b>Slip-Fit Mount:</b> 16225 AZT30SL 16225 BKT30SL	<b>Slip-Fit Mount:</b> 16225 AZT40SL* 16225 BKT40SL*	
Housing	Cast Aluminum		
Wattage/pf, Delivered Lumens & Efficacy	85W, .9pf 7529 lm, 89 lm/W	85W, .9pf 8613 lm, 102 lm/W	
CRI	80+		
Voltage Range	120V-277V, 50-60Hz. Surge protection up to 4kV		
Light Source	2 integrated high-output LEDs with 3-step binning for color consistency. Custom reflector optics. Tested to a Lumen Maintenance L70 of 60,000 hrs.		
Notes	Replaces the equivalent of a 200W Metal Halide. Comes with 3 gel-filled wire nuts. IP66 rated. Vandal proof hardware installed.		
Accessories	15276 Power Post® 15601 Surface Mounting Flange 15609 Junction Box Mounting Bracket 15645, 15656, 15657, 15658 Stems		
Dimensions			



# C-Series In-Ground

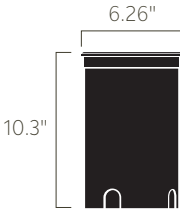

	In-Ground – 10 W			In-Ground – 20 W		
Finish	CBR			CBR		
Color Temp. (CCT)	3000K	4000K	5000K	3000K	4000K	5000K
Item Number by Beam Spread and Finish + CCT	45° Beam Spread 16227 CBR30	45° Beam Spread 16227 CBR40	45° Beam Spread 16227 CBR50	45° Beam Spread 16230 CBR30	45° Beam Spread 16230 CBR40	45° Beam Spread 16230 CBR50
For Example: 16227+CBR+30=16227CBR30	60° Beam Spread 16228 CBR30	60° Beam Spread 16228 CBR40	60° Beam Spread 16228 CBR50	60° Beam Spread 16258 CBR30	60° Beam Spread 16258 CBR40	60° Beam Spread 16258 CBR50
Housing	Cast Brass			Cast Brass		
Wattage, Delivered Lumens & Efficacy	9.7W 775 lm 80 lm/W			20.3W 1625 lm 80 lm/W		
CRI	80					
Voltage Range	120V-277V, 50-60Hz. Surge protection up to 4kV.					
Light Source	Single, high output, energy efficient COB LED					
Notes	Tested to a Lumen Maintenance L70 of ≥ 55,000 hrs.					
Accessories	 16290SS Stainless Steel Trim Ring					
Dimensions						

## Beam Tilt Adjustment

(Set from outside the fixture)

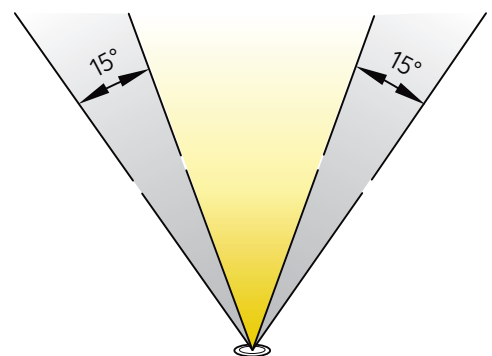

Up to 15° External Beam Tilt Adjustment in Either Direction

Integrated LED – 120V



	Small Accent – 12.5W				Large Accent – 19.5W			
Finish	BBR				BBR			
Color Temperature	3000K - Pure White		4250K - Cool White		3000K - Pure White		4250K - Cool White	
Item Number by Beam Spread and Finish	<b>10° Beam Spread</b> 16200 BBR30		<b>10° Beam Spread</b> 16200 BBR42		<b>10° Beam Spread</b> 16202 BBR30		<b>10° Beam Spread</b> 16202 BBR42	
	<b>35° Beam Spread</b> 16201 BBR30		<b>35° Beam Spread</b> 16201 BBR42		<b>35° Beam Spread</b> 16203 BBR30		<b>35° Beam Spread</b> 16203 BBR42	
	<b>60° Beam Spread</b> 16206 BBR30		<b>60° Beam Spread</b> 16206 BBR42		<b>60° Beam Spread</b> 16207 BBR30		<b>60° Beam Spread</b> 16207 BBR42	
Housing	Cast Brass				Cast Brass			
Wattage/VA, Delivered Lumens & Efficacy	12.5W .13VA, .85pf	590 lm 47 lm/W	12.5W .13VA, .85pf	646 lm 52 lm/W	19.5W .18VA, .90pf	947 lm 49 lm/W	19.5W .18VA, .90pf	993 lm 51 lm/W
CRI	80+				80+			
Voltage Range	108V-132V, 50-60Hz. Surge protection up to 4kV.							
Light Source	5 integrated high-output LEDs with 3-step binning for color consistency. Tested to a Lumen Maintenance L70 of 40,000 hrs.				8 integrated high-output LEDs with 3-step binning for color consistency. Tested to a Lumen Maintenance L70 of 40,000 hrs.			
Notes	Replaces the equivalent of a 50W Halogen. IP66 rated. Brass will naturally patina over time.				Replaces the equivalent of a 75W Halogen. IP66 rated. Brass will naturally patina over time.			
Accessories	<b>15276</b> Power Post® <b>15601</b> Surface Mounting Flange <b>15609</b> Junction Box Mounting Bracket <b>15645, 15656, 15657, 15658</b> Stems							
Dimensions								



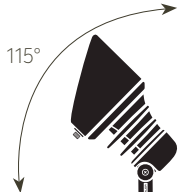

### Large Accent – 29W

Finish	<b>BBR</b>			
Color Temperature	3000K - Pure White		4250K - Cool White	
Item Number by Beam Spread and Finish	<b>10° Beam Spread</b> <b>16204 BBR30</b>  <b>35° Beam Spread</b> <b>16205 BBR30</b>  <b>60° Beam Spread</b> <b>16208 BBR30</b>		<b>10° Beam Spread</b> <b>16204 BBR42</b>  <b>35° Beam Spread</b> <b>16205 BBR42</b>  <b>60° Beam Spread</b> <b>16208 BBR42</b>	
Housing	Cast Brass			
Wattage/VA, Delivered Lumens & Efficacy	29W .27VA, .90pf	1131 lm 39 lm/W	29W .27VA, .90pf	1368 lm 47 lm/W
CRI	80+			
Voltage Range	108V-132V, 50-60Hz. Surge protection up to 4kV.			
Light Source	8 integrated high-output LEDs with 3-step binning for color consistency. Tested to a Lumen Maintenance L70 of 40,000 hrs.			
Notes	Replaces the equivalent of a 100W Halogen. IP66 rated. Brass will naturally patina over time.			
Accessories	<b>15276</b> Power Post® <b>15601</b> Surface Mounting Flange <b>15609</b> Junction Box Mounting Bracket <b>15645, 15656, 15657, 15658</b> Stems			
Dimensions	 			

# Commercial Landscape Lighting

# Retrofit Accent & In-Ground

120V – Requires lamp



Name	Small Accent	Medium Accent	Large Accent
SKU & Finish	15231 AZT 15231 BKT	15241 AZT 15241 BKT	15251 AZT 15251 BKT
LED Lamp Options	7W PAR20 Wet (18081-18086) Compares up to 35W Halogen	12W PAR30L Wet (18111-18116) Compares up to 50W Halogen	17W PAR38 Wet (18093-18098) Compares up to 75W Halogen



Name	Small Compact	Large Compact	Downlight
SKU & Finish	15230 AZT	15250 AZT	15255 AZT
LED Lamp Options	N/A (Incandescent: 35W Max. PAR20 Metal Halide or 50W Max. PAR20 Incandescent)	12W PAR30L Wet (18111-18116) Compares up to 50W Halogen	17W PAR38 Wet (18093-18098) Compares up to 75W Halogen



Name	In-Ground PAR38	Small In-Ground PAR20/PAR30	In-Ground 70W MH Quad-Tap
SKU & Finish	15295 AZ	15268 AZ	15266 AZ
LED Lamp Options	7W PAR20 Wet (18081-18086) Compares up to 35W Halogen 12W PAR30 Wet (18087-18092) Compares up to 50W Halogen 12W PAR30L Wet (18111-18116) Compares up to 50W Halogen 17W PAR38 Wet (18093-18098) Compares up to 75W Halogen	7W PAR20 Wet (18081-18086) Compares up to 35W Halogen 12W PAR30 Wet (18087-18092) Compares up to 50W Halogen 12W PAR30L Wet (18111-18116) Compares up to 50W Halogen	7W PAR20 Wet (18081-18086) Compares up to 35W Halogen 12W PAR30 Wet (18087-18092) Compares up to 50W Halogen 12W PAR30L Wet (18111-18116) Compares up to 50W Halogen

# Retrofit Path & Spread

120V – Requires lamp



**Name** Three Tier

**SKU & Finish** 15205 AZT  
15205 BKT

**LED Lamp Options/ Notes** A19 Damp Location  
Available as stem mount, deck mount or as a bollard. Mounting stems and bollard kits sold separately.



**Name** Large One Tier

**SKU & Finish** 15211 AZT  
15211 BKT

**LED Lamp Options/ Notes** A19 Damp Location  
Available as stem mount, deck mount or as a bollard. Mounting stems and bollard kits sold separately.



**Name** Eclipse™

**SKU & Finish** 15236 BKT  
15236 TZT

**LED Lamp Options/ Notes** A19 Damp Location



**Name** Cross Creek™ Lantern

**SKU & Finish** 15232 AGZ

**LED Lamp Options** A19 Damp Location



**Name** Traditional Marine Lantern

**SKU & Finish** 15239 OZ

**LED Lamp Options** A19 Damp Location

## Features:

- Potted and/or coated electronics protect against moisture
- Operating range from 120V to 277V
- Design & listed for wet location & enclosed fixtures
- Can be used in open fixtures or outdoor sockets
- Cast aluminum heat sink, anodized black, for increased thermal management
- Integrated driver and transformer with high output LEDs tightly binned for high CRI, color uniformity and color quality
- 30,000 hour life in an enclosed fixture
- FCC compliance ensures no interference with other electronic devices
- High total lumens and lumens per watt (efficacy)
- Custom optics deliver center-to-edge beam uniformity and glare reduction
- Interior use as well
- 6-year warranty



**PAR20**  
Wet Location



**PAR30**  
Wet Location



**PAR30**  
Longneck  
Wet Location



**PAR38**  
Wet Location

## Photometrics: 120V-277V LED Lamps

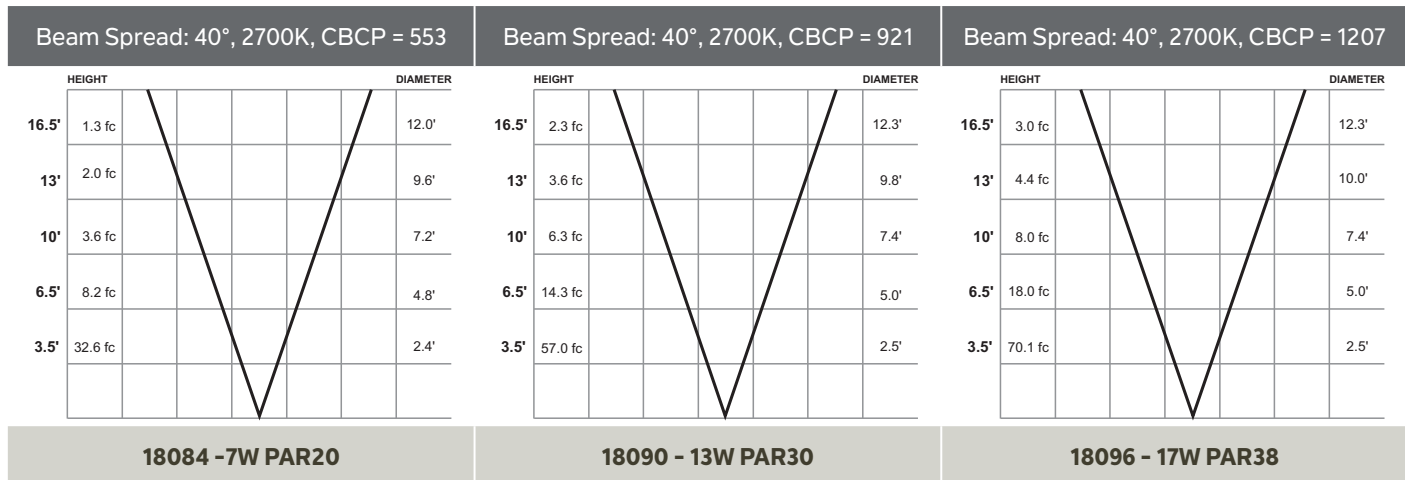

\* The curves indicate the illuminated area and the average illumination when the luminaire is at different distances. Stated foot-candles are for bare lamps only. For additional photometrics, visit [Kichler.com/Landscape](http://Kichler.com/Landscape)

## 120V-277V LED Lamps

LAMP	BASE / LAMP TYPE	WATTS	KELVIN / LUMENS	BEAM ANGLE/ITEM #	
				25° Spot	40° Flood
	<b>PAR20</b> Wet Location <b>W</b>	7W Compares up to 35W Halogen	2700K – Warm White 310 lm	<b>18081</b>	<b>18084</b>
			3000K – Pure White 330 lm	<b>18082</b>	<b>18085</b>
			4200K – Cool White 350 lm	<b>18083</b>	<b>18086</b>
				<b>25° Spot</b>	<b>40° Flood</b>
	<b>PAR30</b> Wet Location <b>W</b>	12W Compares up to 50W Halogen	2700K – Warm White 580Lm	<b>18087</b>	<b>18090</b>
			3000K – Pure White 610Lm	<b>18088</b>	<b>18091</b>
			4200K – Cool White 640Lm	<b>18089</b>	<b>18092</b>
				<b>25° Spot</b>	<b>40° Flood</b>
	<b>PAR30</b> Longneck Wet Location <b>W</b>	12W Compares up to 50W Halogen	2700K – Warm White 580Lm	<b>18111</b>	<b>18114</b>
			3000K – Pure White 610Lm	<b>18112</b>	<b>18115</b>
			4200K – Cool White 640Lm	<b>18113</b>	<b>18116</b>
				<b>25° Spot</b>	<b>40° Flood</b>
	<b>PAR38</b> Wet Location <b>W</b>	17W Compares up to 75W Halogen	2700K – Warm White 800Lm	<b>18093</b>	<b>18096</b>
			3000K – Pure White 850Lm	<b>18094</b>	<b>18097</b>
			4200K – Cool White 900Lm	<b>18095</b>	<b>18098</b>

**W** Wet location versions designed and listed for use in an enclosed or open fixture. Using lamp in enclosed fixtures can result in up to 30-40% loss in lumen output based on test data.

## C-Series Accent Accessories



Name	Long Visor/Cowl	Hexcell Louver	Frosted Lens	Amber Lens	Green Lens
SKU & Finish	16280 AZT, BKT 16281 AZT, BKT	16282 AZT, BKT 16283 AZT, BKT	16284 AZT, BKT 16285 AZT, BKT	16286 AZT, BKT 16287 AZT, BKT	16288 AZT, BKT 16289 AZT, BKT
Notes	16280 for use with: Small Accent 16209-16214 16281 for use with: Large Accent 16215-16220	16282 for use with: Small Accent 16209-16214 16283 for use with: Large Accent 16215-16220	16284 for use with: Small Accent 16209-16214 16285 for use with: Large Accent 16215-16220	16286 for use with: Small Accent 16209-16214 16287 for use with: Large Accent 16215-16220	16288 for use with: Small Accent 16209-16214 16289 for use with: Large Accent 16215-16220

## C-Series, 120V LED & Retrofit Accessories

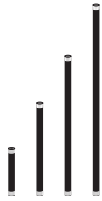

Name	Fixture Mounting Stems 1/2-14 NPSM Thd. .75" Dia. Overall	Power Post®	Surface Mounting Flange	Junction Box Mounting Bracket
SKU & Finish	15645 AZT, BKT 6" 15656 AZT, BKT 12" 15657 AZT, BKT 18" 15658 AZT, BKT 24"	15276 BK For use with: 15205 AZT, 15205 BKT, 15211 AZT, 15211 BKT, 15232 AGZ, 5236 BKT, 15236 TZ, 15239 OB, 15239 OZ and all other .5" NPSM threaded fixtures	15601 AZT 15601 BKT 15601 WHT	15609 AZT 15609 BKT 15609 WHT
Notes	1/2-14 NPSM stems will require additional Coupler (15649) or Elbow (15647) for accent light use	2.25" W x 19" H x 4.375" L	4" D 1/2-14 NPSM Thd.	2.39" W x 5.56" H

120V LED & Retrofit Accessories

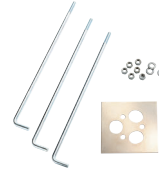

Name	Concrete Installation Kit	Bollard Mounting Stake	Bollard Template Kit	Flange Mounting Nipple
SKU & Finish	<b>15608 AZ</b> For use with: 15262, 15263, 15266, 15295, 151GT100, 151GT300, 151GT600	<b>15578 BK</b> For use with all bollard mounting kits on 12V and 120V fixtures: 15005, 15205, 15211	<b>15671 ST</b> For use with all bollard mounting kits on 12V and 120V fixtures: 15005, 15205, 15211	<b>15602 AL</b>
Notes	7" D x 5.19" H	23" H		1/2-14 NPSM Thd.

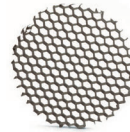

Name	Gel Encapsulant	Blue Lens	45° Hexcell Louver	Rock Guard
SKU & Finish	<b>15616 WH10</b> 10-pack	<b>15623 BL</b> For use with: 15231	<b>15638 BK</b> For use with: 15241	<b>15688 AZ</b> For use with: 15263, 15264, 15265, 15295
Notes				9.63" Dia. x 1.29" H



Name	PAR20 Medium Cowl	PAR20 Long Cowl	PAR30 Medium Cowl	PAR30 Long Cowl
SKU & Finish	<b>15620 AZT, BKT</b> For use with: 15231	<b>15628 AZT, BKT</b> For use with: 15231	<b>15640 AZT, BKT</b> For use with: 15241	<b>15648 AZT, BKT</b> For use with: 15241
Notes	3.32" L	7.45" L	3.87" L	8.99" L



Name	PAR38 Medium Cowl	PAR38 Long Cowl	PAR20 Cowl	PAR38 Cowl
SKU & Finish	<b>15660 AZT, BKT</b> For use with: 15251, 15255	<b>15668 AZT</b> For use with: 15251, 15255	<b>15630 AZT</b> For use with: 15230	<b>15650 AZT</b> For use with: 15250
Notes	4.92" L	12" L	3.58" L	3.58" L

# 12V Lighting

- 12V Integrated LED & Retrofit Accent** page 180
- 12V Integrated LED & Retrofit In-Ground** page 189
- 12V Integrated LED & Retrofit Path & Spread** page 191
- 12V Hardscape** page 194
- 12V Deck & Patio** page 196
- 12V LED Lamps** page 198
- Controllers & Transformers** page 200
- 12V Accessories** page 202

Kichler Lighting low-voltage lighting systems are designed to work together for a complete professional landscape lighting solution. Our integrated LED fixtures feature options for a variety of lighting techniques, surfaces and needs – including in-ground, accent, hardscape and more – to create a total lighting solution from path to patio.

For FREE, fast layout design and technical support, our Advanced Product Solution team can help: [Kichler.com/APS](http://Kichler.com/APS).







## Accent Lights with VLO

Variable Lumen Output (VLO) technology allows you to easily switch between three lumen outputs without mechanically adjusting the settings on the fixture. The magnet-controlled switch allows the fixture to remain closed, eliminating the increased failure risk or long-term reliability concerns associated with a mechanical adjustment.

### Our Finest Integrated LED Technology

**Custom optics**  
assures no halos or scallops,  
just superb center-to-edge  
uniformity for clean, clear light.

**The switch**  
is fully protected  
from moisture by  
being potted on  
board the driver.

**9-15 volt**  
operating range to assure  
consistent light output  
throughout a run.

**Integrated, fully sealed**  
and encapsulated fixtures keep  
all critical components protected  
against the outdoor elements.

**6,000 volt surge protection**  
guards against power irregularities that can  
be a hazard to LED landscape lighting.



Backed by the Kichler Lighting industry-leading 15-year warranty.  
For details, visit [Kichler.com/Warranty](http://Kichler.com/Warranty)

### VLO makes it easier than ever to design, install and service landscape lighting.

- Create more customized landscape designs while carrying less fixtures in your inventory.
- Quickly adjust the lighting design during the initial installation for the right amount of light output — or years down the road as the landscape application needs changed.



## Incredibly easy to adjust.

Each fixture is conveniently factory-set at the most popular lumen level for maximum efficiency. To change, simply hold the included magnet over the lumen adjustment locator to begin the programming mode. The fixture will flash continuously four times and go dark before blinking to indicate which lumen level is currently programmed. Programming begins from the factory setting and adjusts up in lumens (Level 1 for Large Accent, Level 2 for Small Accent).

VLO Adjustment Settings		Small Accent	Large Accent
Level 1	1: Flashes once <i>included switching magnet</i>	100 lm	*400 lm
Level 2	2: Flashes twice	*200 lm	600 lm
Level 3	3: Flashes three times	300 lm	835 lm

\*Factory setting

## (VLO) Variable Lumen Output



Level 1

Level 2

Level 3

12V LED Small Accent	
Level 1	<b>100 Lumens</b> (shown: 16016 Small Accent, 35° Flood, 2W, 3000K)
Level 2*	<b>200 Lumens</b> (shown: 16016 Small Accent, 35° Flood, 3.5W, 3000K) *Factory setting
Level 3	<b>300 Lumens</b> (shown: 16016 Small Accent, 35° Flood, 5.5W, 3000K)



12V LED Large Accent	
Level 1*	<b>400 Lumens</b> (shown: 16019 Large Accent, 35° Flood, 6W, 3000K) *Factory setting
Level 2	<b>600 Lumens</b> (shown: 16019 Large Accent, 35° Flood, 11W, 3000K)
Level 3	<b>835 Lumens</b> (shown: 16019 Large Accent, 35° Flood, 16W, 3000K)

Note: Beam width/cut-off is dependent on how close the fixture is to the object. Lumen levels are the same for 2700K and 3000K.

Integrated LED – 12V



## Small Accent with Variable Lumen Output

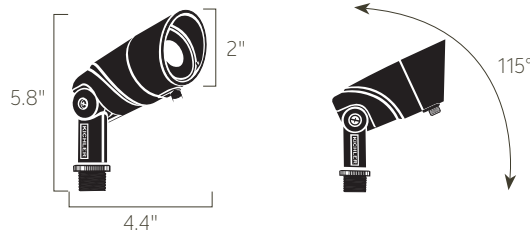

Finishes	AZT (shown), BKT, CBR, WHT (16016 only)		Additional Finishes
Color Temperature	2700K - Warm White	3000K - Pure White	<p><b>BKT</b></p> <p><b>CBR</b></p> <p><b>WHT</b> (35° only)</p>
Item Number by Beam Spread and Finish	<b>15° Spot</b> 16015 AZT27, 16015 BKT27, 16015 CBR27  <b>35° Flood</b> 16016 AZT27, 16016 BKT27, 16016 CBR27, 16016 WHT27  <b>60° Wide Flood</b> 16017 AZT27, 16017 BKT27, 16017 CBR27	<b>15° Spot</b> 16015 AZT30, 16015 BKT30, 16015 CBR30  <b>35° Flood</b> 16016 AZT30, 16016 BKT30, 16016 CBR30, 16016 WHT30  <b>60° Wide Flood</b> 16017 AZT30, 16017 BKT30, 16017 CBR30	
Housing	Cast Aluminum or Cast Brass (CBR)		
Wattage/VA, Delivered Lumens & Efficacy	<b>Level 1</b> = 2W/3.5VA, 100 lm, 50 lm/W <b>Level 2</b> = 3.5W/5.5VA, 200 lm, 57 lm/W <b>Level 3</b> = 5.5W/7.5VA, 300 lm, 55 lm/W	<b>Factory set at Level 2 (200 lm/20W Equivalent)</b> Lumen levels are the same for 2700K and 3000K	
CRI	80+	80+	
Voltage Range	9V-15V AC/DC with no loss in light output. 6kV (6000 volt surge protection) built on board of driver.		
Light Source	1 integrated high-output LED with 3-step binning for color consistency. Custom reflector optics. Tested to a Lumen Maintenance L70 of 50,000 hrs.		
Wiring	48" of usable #18-2, SPT-1W leads		
Notes	Replaces the equivalent of a 10W Halogen (Level 1), 20W Halogen (Level 2) and 30-35W Halogen (Level 3). Includes 8" slotted in-ground stake, 2 gel-filled wire nuts and lumen switching magnetic key. Brass will naturally patina over time. White is only available in 35° Flood.		
Accessories	<b>Cowls &amp; Lenses:</b> Long Cowl, 360 Degree Cowl, Hexcell Louver, Lenses: Red, Amber, Green Foliage, Holiday Green and Frosted	<b>Mounting:</b> Surface Mounting Flange, 3" Round Mounting Base (CBR), Surface Mounting Bracket, Junction Box Mounting Bracket, 90° Elbows, Stem Coupler, Stems, Two Fixture Mount (CBR)	<i>Accessories start on page 202.</i>

Dimensions





### Large Accent with Variable Lumen Output

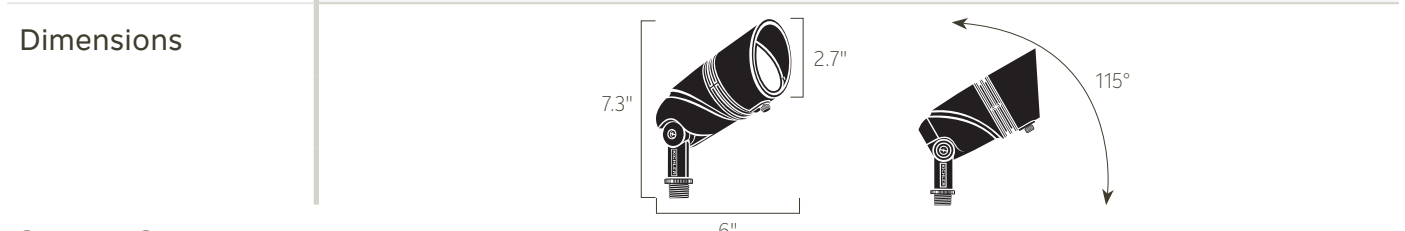

Finishes	BKT (shown), AZT, CBR, WHT (16019 only)		Additional Finishes
Color Temperature	2700K - Warm White	3000K - Pure White	 AZT  CBR  WHT (35° only)
Item Number by Beam Spread and Finish	<b>15° Spot</b> 16018 AZT27, 16018 BKT27, 16018 CBR27  <b>35° Flood</b> 16019 AZT27, 16019 BKT27, 16019 CBR27, 16019 WHT27  <b>60° Wide Flood</b> 16020 AZT27, 16020 BKT27, 16020 CBR27	<b>15° Spot</b> 16018 AZT30, 16018 BKT30, 16018 CBR30  <b>35° Flood</b> 16019 AZT30, 16019 BKT30, 16019 CBR30, 16019 WHT30  <b>60° Wide Flood</b> 16020 AZT30, 16020 BKT30, 16020 CBR30	
Housing	Cast Aluminum or Cast Brass (CBR)		
Wattage/VA, Delivered Lumens & Efficacy	<b>Level 1</b> = 5.25W/8.5VA, 400 lm, 76 lm/W <b>Level 2</b> = 8.5W/12.5VA, 600 lm, 70 lm/W <b>Level 3</b> = 12W/17VA, 835 lm, 69 lm/W	<b>Factory set at Level 1 (400 lm/35W Equivalent)</b> Lumen levels are the same for 2700K and 3000K	
CRI	80+	80+	
Voltage Range	9V-15V AC/DC with no loss in light output. 6kV (6000 volt surge protection) built on board of driver		
Light Source	1 integrated high-output chip-on-board LED with 3-step binning for color consistency. Custom T.I.R. (Total Internal Reflection) lens optics. Tested to a Lumen Maintenance L70 of 50,000 hrs.		
Wiring	48" of usable #18-2, SPT-1W leads		
Notes	Replaces the equivalent of a 35-40W Halogen (Level 1), 50W Halogen (Level 2) and 75W Halogen (Level 3). Includes 8" slotted in-ground stake, 2 gel-filled wire nuts and lumen switching magnetic key. Brass will naturally patina over time. White is only available in 35° Flood.		
Accessories	<b>Cowls &amp; Lenses:</b> Long Cowl, 360 Degree Cowl, Hexcell Louver, Lenses: Red, Amber, Green Foliage, Holiday Green and Frosted	<b>Mounting:</b> Surface Mounting Flange, 3" Round Mounting Base (CBR), Surface Mounting Bracket, Junction Box Mounting Bracket, 90° Elbows, Stem Coupler, Stems, Two Fixture Mount (CBR)	<i>Accessories start on page 202.</i>



## Integrated LED – 12V



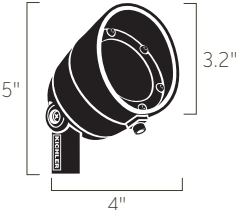
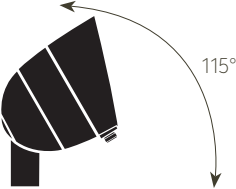

### LED Accent – 2.5W

Finishes	CBR (shown), AZT, BKT		Additional Finishes
Color Temperature	2700K - Warm White	3000K - Pure White	 AZT   BKT
Item Number by Beam Spread and Finish	<b>10° Spot</b> 16150 AZT27, 16150 BKT27, 16150 CBR27  <b>35° Flood</b> 16151 AZT27, 16151 BKT27, 16151 CBR27  <b>60° Wide Flood</b> 16152 AZT27, 16152 BKT27, 16152 CBR27	<b>10° Spot</b> 16150 AZT30, 16150 BKT30, 16150 CBR30  <b>35° Flood</b> 16151 AZT30, 16151 BKT30, 16151 CBR30  <b>60° Wide Flood</b> 16152 AZT30, 16152 BKT30, 16152 CBR30	
Housing	Cast Aluminum or Cast Brass (CBR)		
Wattage/VA, Delivered Lumens & Efficacy	2.5W, 3.5VA	200 lm, 80 lm/W	<i>Lumen levels are the same for 2700K and 3000K</i>
CRI	80+		
Voltage Range	9V-15V AC/DC with no loss in light output. 4kV (4000 volt surge protection).		
Light Source	3 integrated high-output LEDs with 3-step binning for color consistency. Custom T.I.R. (Total Internal Reflection) acrylic Lens. Tested to a Lumen Maintenance L70 of 40,000 hrs.		
Wiring	48" of usable #18-2, SPT-1W leads		
Notes	Replaces the equivalent of a 20W Halogen. Includes 8" slotted in-ground stake and 2 gel-filled wire nuts. Brass will naturally patina over time. Backed by a 10-year warranty - visit <a href="http://Kichler.com/Warranty">Kichler.com/Warranty</a> for details.		
Accessories	<b>Mounting:</b> 15601 Surface Mounting Flange 15607 Surface Mounting Bracket 15609 Junction Box Mounting Bracket 15647, 15514 90° Elbow 15649 Stem Coupler 15645, 15656, 15657, 15658, 15570 Stems 15509, 15510, 15511, 15512, 15513 Stems (CBR) 15515 Two Fixture Mount (CBR)	15493 Round Mounting Base (CBR)  <b>Cowls &amp; Lenses:</b> 16076 Long Cowl 15875 AMB Amber Lens 15875 HGRN Holiday Green Lens 15875 RD Red Lens 15885 GRN Green Foliage Lens 15895 FRO Frosted Lens	
Dimensions	 		



**LED Accent - 3.5W**

Finishes	<b>BKT (shown), AZT, CBR</b>		Additional Finishes
Color Temperature	2700K - Warm White	3000K - Pure White	 AZT   CBR
Item Number by Beam Spread and Finish	<b>10° Spot</b> 16153 AZT27, 16153 BKT27, 16153 CBR27  <b>35° Flood</b> 16154 AZT27, 16154 BKT27, 16154 CBR27  <b>60° Wide Flood</b> 16155 AZT27, 16155 BKT27, 16155 CBR27	<b>10° Spot</b> 16153 AZT30, 16153 BKT30, 16153 CBR30  <b>35° Flood</b> 16154 AZT30, 16154 BKT30, 16154 CBR30  <b>60° Wide Flood</b> 16155 AZT30, 16155 BKT30, 16155 CBR30	
Housing	Cast Aluminum or Cast Brass (CBR)		
Wattage/VA, Delivered Lumens & Efficacy	3.5W, 5.25VA	300 lm, 86 lm/W	<i>Lumen levels are the same for 2700K and 3000K</i>
CRI	80+		
Voltage Range	9V-15V AC/DC with no loss in light output. 4kV (4000 volt surge protection).		
Light Source	6 integrated high-output LEDs with 3-step binning for color consistency. Custom T.I.R. (Total Internal Reflection) acrylic lens. Tested to a Lumen Maintenance L70 of 40,000 hrs.		
Wiring	48" of usable #18-2, SPT-1W leads		
Notes	Replaces the equivalent of a 35W Halogen. Includes 8" slotted in-ground stake and 2 gel-filled wire nuts. Brass will naturally patina over time. Backed by a 10-year warranty - visit <a href="http://Kichler.com/Warranty">Kichler.com/Warranty</a> for details.		
Accessories	<b>Mounting:</b> 15601 Surface Mounting Flange 15607 Surface Mounting Bracket 15609 Junction Box Mounting Bracket 15647, 15514 90° Elbow 15649 Stem Coupler 15645, 15656, 15657, 15658, 15570 Stems 15509, 15510, 15511, 15512, 15513 Stems (CBR) 15515 Two Fixture Mount (CBR)	15493 Round Mounting Base (CBR)  <b>Cowls &amp; Lenses:</b> 16076 Long Cowl 15875 AMB Amber Lens 15875 HGRN Holiday Green Lens 15875 RD Red Lens 15885 GRN Green Foliage Lens 15895 FRO Frosted Lens	

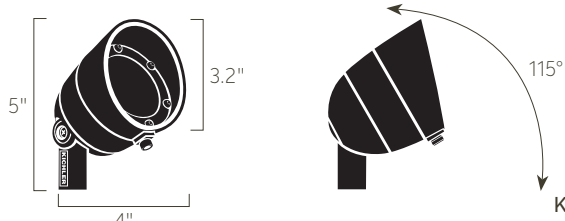
Dimensions	
------------	--

Integrated LED – 12V



## LED Accent – 7W

Finishes	AZT (shown), BKT, CBR		Additional Finishes
Color Temperature	2700K - Warm White		3000K - Pure White
Item Number by Beam Spread and Finish	<p><b>10° Spot</b> 16156 AZT27, 16156 BKT27, 16156 CBR27</p> <p><b>35° Flood</b> 16157 AZT27, 16157 BKT27, 16157 CBR27</p> <p><b>60° Wide Flood</b> 16158 AZT27, 16158 BKT27, 16158 CBR27</p>	<p><b>10° Spot</b> 16156 AZT30, 16156 BKT30, 16156 CBR30</p> <p><b>35° Flood</b> 16157 AZT30, 16157 BKT30, 16157 CBR30</p> <p><b>60° Wide Flood</b> 16158 AZT30, 16158 BKT30, 16158 CBR30</p>	 BKT   CBR
Housing	Cast Aluminum or Cast Brass (CBR)		
Wattage/VA, Delivered Lumens & Efficacy	7W, 10VA	500 lm, 71 lm/W	<i>Lumen levels are the same for 2700K and 3000K</i>
CRI	80+		
Voltage Range	9V-15V AC/DC with no loss in light output. 4kV (4000 volt surge protection).		
Light Source	6 integrated high-output LEDs with 3-step binning for color consistency. Custom T.I.R. (Total Internal Reflection) acrylic lens. Tested to a Lumen Maintenance L70 of 40,000 hrs.		
Wiring	48" of usable #18-2, SPT-1W leads		
Notes	Replaces the equivalent of a 50W Halogen. Includes 8" slotted in-ground stake and 2 gel-filled wire nuts. Brass will naturally patina over time. Backed by a 10-year warranty - visit <a href="http://Kichler.com/Warranty">Kichler.com/Warranty</a> for details.		
Accessories	<p><b>Mounting:</b>                      15601 Surface Mounting Flange                      15607 Surface Mounting Bracket                      15609 Junction Box Mounting Bracket                      15647, 15514 90° Elbow                      15649 Stem Coupler                      15645, 15656, 15657, 15658, 15570 Stems                      15509, 15510, 15511, 15512, 15513 Stems (CBR)                      15515 Two Fixture Mount (CBR)</p>	<p>15493 Round Mounting Base (CBR)</p> <p><b>Cowls &amp; Lenses:</b>                      16076 Long Cowl                      15875 AMB Amber Lens                      15875 HGRN Holiday Green Lens                      15875 RD Red Lens                      15885 GRN Green Foliage Lens                      15895 FRO Frosted Lens</p>	
Dimensions			





# Wall Wash – LED



	Wall Wash		Wall Wash Accent	
Finishes	<b>CBR (shown), AZT, BKT</b>		<b>BKT (shown), AZT</b>	
Color Temperature	2700K - Warm White	3000K - Pure White	2700K - Warm White	3000K - Pure White
Item Number and Finish	<b>16070</b> AZT27R <b>16070</b> CBR27R <b>16070</b> BKT27R	<b>16070</b> AZT30R <b>16070</b> CBR30R <b>16070</b> BKT30R	<b>15861</b> AZT27R <b>15861</b> BKT27R	<b>15861</b> AZT30R <b>15861</b> BKT30R
Housing	Cast Aluminum or Cast Brass (CBR)		Cast Aluminum	
Power Usage at 12V AC Input, VA and Watts	4.3W, 5.8VA		4.3W, 5.8VA	
Color Temp. & CRI	2700K 80+	3000K 80+	2700K 80+	3000K 80+
Voltage Range	9V-15V AC/DC with no loss in light output		9V-15V AC/DC with no loss in light output	
Light Source	8 integrated high-output LEDs with 3-step binning for color consistency. Tested to a Lumen Maintenance L70 of 40,000 hrs.		8 integrated high-output LEDs with 3-step binning for color consistency. Tested to a Lumen Maintenance L70 of 40,000 hrs.	
Delivered Lumens & Efficacy	2700K=294 lm 2700K=67 lm/W	3000K=302 lm 3000K=73 lm/W	2700K=294 lm 2700K=67 lm/W	3000K=302 lm 3000K=73 lm/W
Wiring	35" of usable #18-2, SPT-1W leads. Wire connectors supplied.		64" of usable #18-2, SPT-1W leads. Wire connectors supplied.	
Notes	Beam spread vertical of 80°, horizontal of 100°. Includes 8" slotted in-ground stake. Fully adjustable knuckle. Brass will naturally patina over time.		Beam spread vertical of 108°, horizontal of 111°. Includes 8" slotted in-ground stake. Fully adjustable knuckle. Brass will naturally patina over time.	
Accessories	<b>15601</b> Surface Mounting Flange <b>15607</b> Surface Mounting Bracket <b>15609</b> Junction Box Mounting Bracket <b>15647</b> 90° Elbow <b>15645, 15656, 15657, 15658, 15570</b> Stems		<b>15601</b> Surface Mounting Flange <b>15607</b> Surface Mounting Bracket <b>15647</b> 90° Elbow <b>15645, 15656, 15657, 15658, 15570</b> Stems	
Dimensions				

# Landscape Lighting

# Retrofit Accent

12V – Requires lamp



Name	Mini Accent		MR8 Accent	MR11 Accent
SKU & Finish	15384 AZT 15384 AZT24 15384 BKT	15384 BKT24 15384 CBR 15384 CO	15483 CBR	15484 CBR
LED Lamp Options	4W MR16 (18126-18133) Compares up to 20W Halogen 5W MR16 (18134-18141) Compares up to 35W Halogen 7W MR16 (18142-18149) Compares up to 50W Halogen		2W MR8 (18150-18157) Compares up to 15W Halogen	2.5W MR11 (18158-18165) Compares up to 20W Halogen



Name	MR16 Accent Fixed Socket Adjustable Cowl	MR16 Accent Fixed Socket	Solid Brass Accent
SKU & Finish	15485 CBR	15517 CBR	15475 CBR
LED Lamp Options	4W MR16 (18126-18133) Compares up to 20W Halogen 5W MR16 (18134-18141) Compares up to 35W Halogen 7W MR16 (18142-18149) Compares up to 50W Halogen	4W MR16 (18126-18133) Compares up to 20W Halogen 5W MR16 (18134-18141) Compares up to 35W Halogen 7W MR16 (18142-18149) Compares up to 50W Halogen	4W MR16 (18126-18133) Compares up to 20W Halogen 5W MR16 (18134-18141) Compares up to 35W Halogen 7W MR16 (18142-18149) Compares up to 50W Halogen



Name	PAR36 Uplight	MR16 Downlight	Solid Brass Mini Wall Wash
SKU & Finish	15487 CBR	15486 CBR	15476 CBR
LED Lamp Options	4W PAR36 (18166-18173) Compares up to 20W Halogen 6W PAR36 (18174-18181) Compares up to 35W Halogen 10W PAR36 (18182-18189) Compares up to 50W Halogen 11W PAR36 (18021-18028) Compares up to 50W Halogen 14W PAR36 (18190-18197) Compares up to 75W Halogen	4W MR16 (18126-18133) Compares up to 20W Halogen 5W MR16 (18134-18141) Compares up to 35W Halogen 7W MR16 (18142-18149) Compares up to 50W Halogen	2W T5 Wedge (18120, 18121) Compares up to 16W Xenon 2W T5 Wedge (18204, 18205) Compares up to 20W Halogen 1.2W T5 Wedge (18198, 18199) Compares up to 10W Halogen

# Retrofit Hanging Accent

12V – Requires lamp



	Solid Hanging Light	Twinkler Hanging Light
Finishes	<b>CBR</b>	<b>CBR</b>
Item Number and Finish	<b>15500 CBR</b>	<b>15501 CBR</b>
Housing	Cast Brass	Cast Brass
Lamp Base	12V Bi-Pin, high-temperature porcelain socket	
Lamp Options-Power Usage at 12V AC input	<b>LED only:</b> 2W MR8 (18150-18157) Compares up to 15W Halogen 2.5W MR11 (18158-18165) Compares up to 20W Halogen 4W MR16 (18126-18133) Compares up to 20W Halogen 5W MR16 (18134-18141) Compares up to 35W Halogen 7W MR16 (18142-18149) Compares up to 50W Halogen 1.2W Micro Ceramic (18200, 18201) Compares up to 10W Halogen 2W T3/G4 Bi-Pin (18206, 18207) Compares up to 20W Halogen	<b>LED only:</b> 2W MR8 (18150-18157) Compares up to 15W Halogen 2.5W MR11 (18158-18165) Compares up to 20W Halogen 4W MR16 (18126-18133) Compares up to 20W Halogen 5W MR16 (18134-18141) Compares up to 35W Halogen 7W MR16 (18142-18149) Compares up to 50W Halogen 1.2W Micro Ceramic (18200, 18201) Compares up to 10W Halogen 2W T3/G4 Bi-Pin (18206, 18207) Compares up to 20W Halogen
Wiring	36" of usable #18-2, SPT-1W leads. Cable connectors are not included.	36" of usable #18-2, SPT-1W leads. Cable connectors are not included.
Notes	Includes mounting bracket. 72" brass chain with removable links. Brass will naturally patina over time.	Includes mounting bracket. 72" brass chain with removable links. Brass will naturally patina over time.
Dimensions	<p>6' Chain and Mounting Bracket Provided</p>	<p>6' Chain and Mounting Bracket Provided</p>



Integrated LED – 12V



## 2-in-1 Water Accent

Finishes	SS		
Color Temperature	2700K - Warm White	3000K - Pure White	4200K - Cool White
Item Number and Finish	15711 SS27	15711 SS	15711 SS42
Housing	Stainless Steel housing with integrated cowl		
Power Usage at 12V AC Input VA and Watts	3.4W, 4.9VA		
Color Temp. & CRI	2700K, 80+	3000K, 80+	4200K, 80+
Voltage Range	9V-15V AC/DC with no loss in light output		
Light Source	1 integrated high-output LED with 3-step binning for color consistency. Tested to a Lumen Maintenance L70 of 40,000 hours.		
Delivered Lumens & Efficacy	2700K = 135 lm 2700K = 40 lm/W	3000K = 150 lm 3000K = 44 lm/W	4200K = 180 lm 4200K = 53 lm/W
Wiring	25' of usable #18-2, SPT-2W leads		
Notes	Custom reflector optics. Filled and sealed with two types of premium encapsulant to ensure fixture is completely watertight, 1/4-20 threaded mounting tap. Can also be used out of water as a mini accent light. Not recommended for use in salt water.		



Name	Multi Fixture Weighted Base	Out of Water Bracket	Single Fixture Weighted Base
SKU & Finish	15776 BK	15777 SS	15778 BK
Notes	3.5W x 2.75H x 3.5L Unique heavy weighted 3-pronged underwater accessory for 2 or 3 fixtures (15711 sold separately) to give maximum flexibility and directional capability.	1.5W x 1.44H x 2.5L Stainless steel, easy-mount bracket (15711 sold separately) for use above ground on any surface – ideal for wood and masonry when used on decks, patios or overhangs.	3.5W x 2.75H x 3.5L Heavy weight 1-prong underwater light (15711 sold separately) accessory for standard installations. Provides advanced directional capability.

# Retrofit In-Ground

12V – Requires lamp



Name	MR8 Recessed Basic Trim	MR8 Recessed Louvered	MR8 Recessed with Cowl
SKU & Finish	15490 CBR	15492 CBR	15491 CBR
LED Lamp Options	2W MR8 (18150-18157) Compares to 15W Halogen	2W MR8 (18150-18157) Compares to 15W Halogen	2W MR8 (18150-18157) Compares to 15W Halogen



Name	Brass Trim In-Ground	Brass Beacon In-Ground	Brass Rock Guard In-Ground
SKU & Finish	15495 CBR	15498 CBR	15497 CBR
LED Lamp Options	4W MR16 (18126-18133) Compares up to 20W Halogen 5W MR16 (18134-18141) Compares up to 35W Halogen 7W MR16 (18142-18149) Compares up to 50W Halogen	4W MR16 (18126-18133) Compares up to 20W Halogen 5W MR16 (18134-18141) Compares up to 35W Halogen 7W MR16 (18142-18149) Compares up to 50W Halogen	4W MR16 (18126-18133) Compares up to 20W Halogen 5W MR16 (18134-18141) Compares up to 35W Halogen 7W MR16 (18142-18149) Compares up to 50W Halogen



Name	Brass Cowl In-Ground	Brass Side Throw In-Ground
SKU & Finish	15496 CBR	15499 CBR
LED Lamp Options	4W MR16 (18126-18133) Compares up to 20W Halogen 5W MR16 (18134-18141) Compares up to 35W Halogen 7W MR16 (18142-18149) Compares up to 50W Halogen	4W MR16 (18126-18133) Compares up to 20W Halogen 5W MR16 (18134-18141) Compares up to 35W Halogen 7W MR16 (18142-18149) Compares up to 50W Halogen

# Landscape Lighting

# Retrofit In-Ground

12V – Requires lamp



Name	PAR36 Well Brass Trim	PAR36 Well Rock Guard	Solid Brass In-Ground
SKU & Finish	15507 CBR	15508 CBR	15481 CBR
LED Lamp Options	4W PAR36 (18166-18173) Compares up to 20W Halogen 6W PAR36 (18174-18181) Compares up to 35W Halogen 10W PAR36 (18182-18189) Compares up to 50W Halogen 11W PAR36 (18021-18028) Compares up to 50W Halogen 14W PAR36 (18190-18197) Compares up to 75W Halogen	4W PAR36 (18166-18173) Compares up to 20W Halogen 6W PAR36 (18174-18181) Compares up to 35W Halogen 10W PAR36 (18182-18189) Compares up to 50W Halogen 11W PAR36 (18021-18028) Compares up to 50W Halogen 14W PAR36 (18190-18197) Compares up to 75W Halogen	4W PAR36 (18126-18133) Compares up to 20W Halogen 5W PAR36 (18134-18141) Compares up to 35W Halogen 7W PAR36 (18142-18149) Compares up to 50W Halogen



Name	Enclosed PAR36 In-Ground
SKU & Finish	15194 AZ
LED Lamp Options	4W PAR36 (18166-18173) Compares up to 20W Halogen 6W PAR36 (18174-18181) Compares up to 35W Halogen 10W PAR36 (18182-18189) Compares up to 50W Halogen 11W PAR36 (18021-18028) Compares up to 50W Halogen 14W PAR36 (18190-18197) Compares up to 75W Halogen





# Path & Spread – LED

## Integrated LED – 12V



Name	Decorative Hammered Roof	
SKU & Finish	15843 CO27 15843 TZT27	15843 CO 15843 TZT
Watt/VA	3.8W/4.95VA	
Kelvin & Lumens	2700K - Warm White 168 lm, 48 lm/W	3000K - Pure White 182 lm, 49 lm/W



Name	Cast Hammered Roof	
SKU & Finish	15871 CBR27 15871 TZT27	15871 CBR30 15871 TZT
Watt/VA	3.8W/4.95VA	
Kelvin & Lumens	2700K - Warm White 168 lm, 48 lm/W	3000K - Pure White 182 lm, 49 lm/W



Name	Fundamentals™	
SKU & Finish	15839 CO27R 15839 TZT27R	15839 CO30R 15839 TZT30R
Watt/VA	4.3W/5.8VA	
Kelvin & Lumens	2700K - Warm White 294 lm, 67 lm/W	3000K - Pure White 302 lm, 73 lm/W

Optional **FM128296BKT** Glare Guard Reflector



Name	Fundamentals™	
SKU & Finish	16120 AZT27 16120 CBR27 16120 BKT27	16120 AZT30 16120 CBR30 16120 BKT30
Watt/VA	4.3W/5.8VA	
Kelvin & Lumens	2700K - Warm White 294 lm, 67 lm/W	3000K - Pure White 302 lm, 73 lm/W



Name	Forged	
SKU & Finish	15803 AZT27R	15803 AZT30R
Watt/VA	3.8W/4.95VA	
Kelvin & Lumens	2700K - Warm White 168 lm, 46 lm/W	3000K - Pure White 182 lm, 49 lm/W



Name	Ripley™	
SKU & Finish	15800 AZT27R 15800 CBR27	15800 AZT30R 15800 CBR30
Watt/VA	4.3W/5.8VA	
Kelvin & Lumens	2700K - Warm White 294 lm, 67 lm/W	3000K - Pure White 302 lm, 73 lm/W

Optional **FM128296BKT** Glare Guard Reflector



Name	Shallow Shade Small	
SKU & Finish	15805 BKT27R	15805 BKT30R
Watt/VA	4W/5.8VA	
Kelvin & Lumens	2700K - Warm White 126 lm, 31 lm/W	3000K - Pure White 140 lm, 35 lm/W



Name	Shallow Shade Large	
SKU & Finish	15806 BKT27R	15806 BKT30R
Watt/VA	4W/5.8VA	
Kelvin & Lumens	2700K - Warm White 126 lm, 31 lm/W	3000K - Pure White 140 lm, 35 lm/W



Name	Broad Roof	
SKU & Finish	15833 AZT27R	15833 AZT30R
Watt/VA	4W/5.8VA	
Kelvin & Lumens	2700K - Warm White 126 lm, 31 lm/W	3000K - Pure White 140 lm, 35 lm/W



Name	Side Mount	
SKU & Finish	15815 AZT27R 15815 BKT27R	15815 AZT30R 15815 BKT30R
Watt/VA	4.3W/5.8VA	
Kelvin & Lumens	2700K - Warm White 294 lm, 67 lm/W	3000K - Pure White 302 lm, 73 lm/W



Name	Side Mount Cast Brass	
SKU & Finish	15827 CBR27	15827 CBR30
Watt/VA	4.3W/5.8VA	
Kelvin & Lumens	2700K - Warm White 294 lm, 67 lm/W	3000K - Pure White 302 lm, 73 lm/W



Name	Center Mount	
SKU & Finish	15826 AZT27R 15826 BKT27R	15826 AZT30R 15826 BKT30R
Watt/VA	4.3W/5.8VA	
Kelvin & Lumens	2700K - Warm White 294 lm, 67 lm/W	3000K - Pure White 302 lm, 73 lm/W

Optional **FM128296BKT** Glare Guard Reflector



## Integrated LED – 12V



Name	6" Dome		8" Dome		8" Dome Short Stem	
SKU & Finish	15870 AZT27R 15870 CBR27 15870 BKT27R	15870 AZT30R 15870 CBR30 15870 BKT30R	15810 AZT27R 15810 CBR27 15810 BKT27R	15810 AZT30R 15810 CBR30 15810 BKT30R	15811 AZT27R	15811 AZT30R
Watt/VA	4.3W/5.8VA		4.3W/5.8VA		4.3W/5.8VA	
Kelvin & Lumens	2700K - Warm White 294 lm, 67 lm/W	3000K - Pure White 302 lm, 73 lm/W	2700K - Warm White 294 lm, 67 lm/W	3000K - Pure White 302 lm, 73 lm/W	2700K - Warm White 294 lm, 67 lm/W	3000K - Pure White 302 lm, 73 lm/W
	Optional <b>FM128296BKT</b> Glare Guard Reflector		Optional <b>FM128296BKT</b> Glare Guard Reflector		Optional <b>FM128296BKT</b> Glare Guard Reflector	



Name	Llena™		Llenita™		Round Tiered	
SKU & Finish	15820 AZT27 15820 CBR27 15820 CO27	15820 AZT 15820 CBR30 15820 CO	15821 AZT27 15821 CBR27 15821 CO27	15821 AZT 15821 CBR30 15821 CO	16124 AGZ27 16124 BKT27 16124 CW27	16124 AGZ30 16124 BKT30 16124 CW30
Watt/VA	3.8W/4.95VA		3.8W/4.95VA		3.8W/4.95VA	
Kelvin & Lumens	2700K - Warm White 168 lm, 46 lm/W	3000K - Pure White 182 lm, 49 lm/W	2700K - Warm White 168 lm, 46 lm/W	3000K - Pure White 182 lm, 49 lm/W	2700K - Warm White 168 lm, 46 lm/W	3000K - Pure White 182 lm, 46 lm/W



Name	Pierced Dome		Louvered Bollard		Tee Bollard	
SKU & Finish	15857 AZT27R	15857 AZT30R	16130 AZT28 16130 BKT28		16131 AZT28 16131 BKT28	
Watt/VA	3.8W/4.95VA		3.5W/5.67VA		3.5W/5.67VA	
Kelvin & Lumens	2700K - Warm White 168 lm, 46 lm/W	3000K - Pure White 182 lm, 49 lm/W	2800K - Warm White 224 lm, 64 lm/W		2800K - Warm White 224 lm, 64 lm/W	



Name	Side Throw Bollard		Mission Bollard	
SKU & Finish	16132 AZT28 16132 BKT28		16133 AZT28 16133 BKT28	
Watt/VA	3.5W/5.67VA		3.5W/5.67VA	
Kelvin & Lumens	2800K - Warm White 224 lm, 64 lm/W		2800K - Warm White 224 lm, 64 lm/W	



# Retrofit Path & Spread

## 12V – Requires lamp



Name	Adjustable Height Small	Adjustable Height Large	Solid Brass Missionary
SKU & Finish	15502 CBR	15503 CBR	15480 CBR
LED Lamp Options	2W G4/T3 (18042, 18043) Compares up to 20W Halogen 1.2W T3/G4 (18200, 18201) Compares up to 10W Halogen 2W T3/G4 (18206, 18207) Compares up to 20W Halogen	2W G4/T3 (18042, 18043) Compares up to 20W Halogen 1.2W T3/G4 (18200, 18201) Compares up to 10W Halogen 2W T3/G4 (18206, 18207) Compares up to 20W Halogen	2W G4/T3 (18042, 18043) Compares up to 20W Halogen 1.2W T3/G4 (18200, 18201) Compares up to 10W Halogen 2W T3/G4 (18206, 18207) Compares up to 20W Halogen



Name	6" Dome	Solid Brass Traditional	Small Hat Brass
SKU & Finish	15470 AZT 15470 BKT	15478 CBR	15506 CBR
LED Lamp Options	2W T5 Wedge (18039, 18040) Compares up to 16W Xenon 1.2W T3/G4 (18200, 18201) Compares up to 10W Halogen 2W T3/G4 (18206, 18207) Compares up to 20W Halogen	2W G4/T3 (18042, 18043) Compares up to 20W Halogen 1.2W T3/G4 (18200, 18201) Compares up to 10W Halogen 2W T3/G4 (18206, 18207) Compares up to 20W Halogen	2W G4/T3 (18042, 18043) Compares up to 20W Halogen 1.2W T3/G4 (18200, 18201) Compares up to 10W Halogen 2W T3/G4 (18206, 18207) Compares up to 20W Halogen



Name	Small Hat Copper	Medium Hat Copper
SKU & Finish	15504 CO	15505 CO
LED Lamp Options	2W G4/T3 (18042, 18043) Compares up to 20W Halogen 1.2W T3/G4 (18200, 18201) Compares up to 10W Halogen 2W T3/G4 (18206, 18207) Compares up to 20W Halogen	2W G4/T3 (18042, 18043) Compares up to 20W Halogen 1.2W T3/G4 (18200, 18201) Compares up to 10W Halogen 2W T3/G4 (18206, 18207) Compares up to 20W Halogen

## Integrated LED – 12V

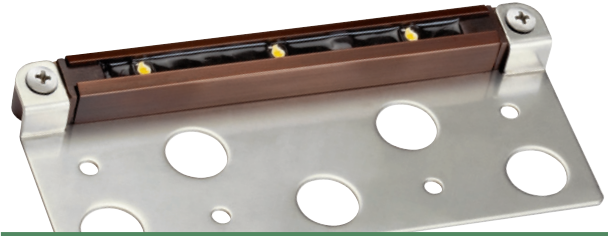

Name	1 LED Fixture (with Bracket) - 3" L			
SKU & Finish	15744 AZT27 15744 BBR27 15744 CO27	15744 GRY27 15744 SD27 15744 WHT27	15744 AZT30 15744 BBR30 15744 CO30	15744 GRY30 15744 SD30 15744 WHT30
Watt/VA	.19W/.28VA			
Kelvin & Lumens	2700K - Warm White 8.4 lm, 44 lm/W		3000K - Pure White 8.6 lm, 45 lm/W	

Name	3 LED Fixture (with Bracket) - 6.9" L			
SKU & Finish	15745 AZT27 15745 BBR27 15745 CO27	15745 GRY27 15745 SD27 15745 WHT27	15745 AZT30 15745 BBR30 15745 CO30	15745 GRY30 15745 SD30 15745 WHT30
Watt/VA	.75W/1.3VA			
Kelvin & Lumens	2700K - Warm White 34.7 lm, 46 lm/W		3000K - Pure White 44.5 lm, 59 lm/W	

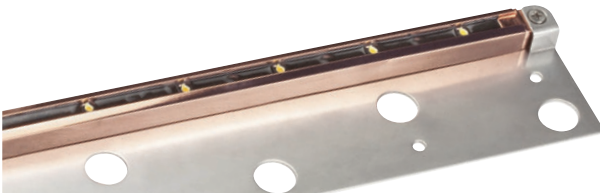

Name	6 LED Fixture (with Bracket) - 12.9" L			
SKU & Finish	15746 AZT27 15746 BBR27 15746 CO27	15746 GRY27 15746 SD27 15746 WHT27	15746 AZT30 15746 BBR30 15746 CO30	15746 GRY30 15746 SD30 15746 WHT30
Watt/VA	1.4W/2.4VA			
Kelvin & Lumens	2700K - Warm White 69.5 lm, 49 lm/W		3000K - Pure White 88 lm, 63 lm/W	

Name	9 LED Fixture (with Bracket) - 18.9" L			
SKU & Finish	15756 AZT27 15756 BBR27 15756 CO27	15756 GRY27 15756 SD27 15756 WHT27	15756 AZT30 15756 BBR30 15756 CO30	15756 GRY30 15756 SD30 15756 WHT30
Watt/VA	2.2W/3.7VA			
Kelvin & Lumens	2700K - Warm White 104.2 lm, 47 lm/W		3000K - Pure White 132 lm, 60 lm/W	

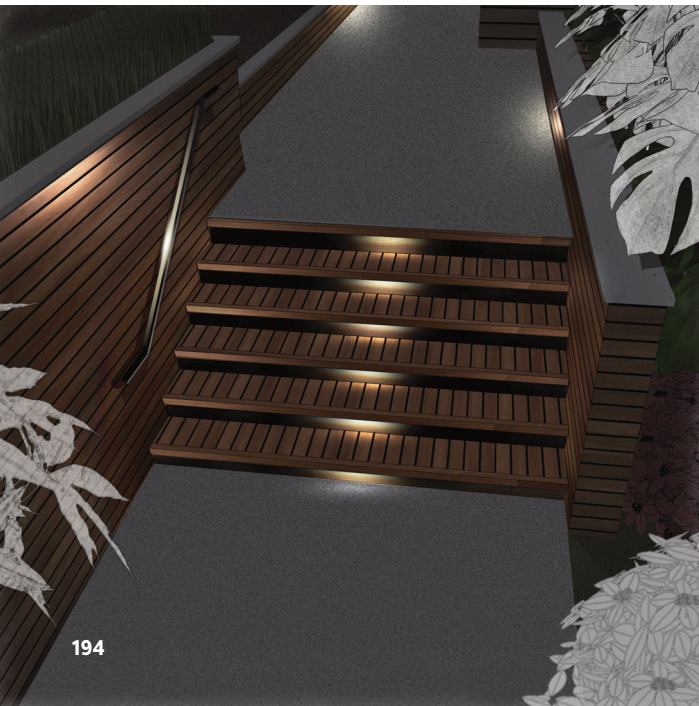

## Hardscape Lighting

Highlight stone features, retaining walls, outdoor kitchens, steps, handrails, benches and more.

*Recommended fixture: 12V 3 LED Fixture 15745 (above)*



# Hardscape – LED & Accessories



Name	<b>1 LED Fixture (without Bracket) - 3" L</b>	
SKU & Finish	15734 AZT30 15734 BBR30 15734 CO30	15734 GRY30 15734 SD30 15734 WHT30
Watt/VA	.19W/.28VA	
Kelvin & Lumens	3000K - Pure White 8.6 lm, 45 lm/W	

Name	<b>3 LED Fixture (without Bracket) - 6.9" L</b>	
SKU & Finish	15735 AZT30 15735 BBR30 15735 CO30	15735 GRY30 15735 SD30 15735 WHT30
Watt/VA	.75W/1.3VA	
Kelvin & Lumens	3000K - Pure White 44.5 lm, 59 lm/W	

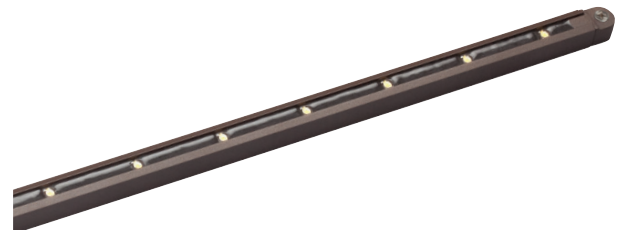

Name	<b>6 LED Fixture (without Bracket) - 12.9" L</b>	
SKU & Finish	15736 AZT30 15736 BBR30 15736 CO30	15736 GRY30 15736 SD30 15736 WHT30
Watt/VA	1.4W/2.4VA	
Kelvin & Lumens	3000K - Pure White 88 lm, 61 lm/W	

Name	<b>9 LED Fixture (without Bracket) - 18.9" L</b>	
SKU & Finish	15755 AZT30 15755 BBR30 15755 CO30	15755 GRY30 15755 SD30 15755 WHT30
Watt/VA	2.2W/3.7VA	
Kelvin & Lumens	3000K - Pure White 132 lm, 62 lm/W	



Name	<b>1 LED Flat Mount Bracket</b>	
SKU & Finish	15716 SS	
Notes	Mounting hardware included	

Name	<b>3 LED Flat Mount Bracket</b>	
SKU & Finish	15717 SS	
Notes	Mounting hardware included	



Name	<b>6 LED Flat Mount Bracket</b>	
SKU & Finish	15718 SS	
Notes	Mounting hardware included	

Name	<b>9 LED Flat Mount Bracket</b>	
SKU & Finish	15719 SS	
Notes	Mounting hardware included	



## Integrated LED – 12V



Name	Brick Light (with Louvers)		Brick Light (without Louvers)		Mini Step Light (with Louvers)	
SKU & Finish	15773 AZT27R	15773 AZT30R	15774 AZT27R	15774 AZT30R	15782 AZT27R 15782 CBR27 15782 BKT27R 15782 CO27R 15782 WHT27R	15782 AZT30R 15782 CBR30 15782 BKT30R 15782 CO30R 15782 WHT30R
Watt/VA	1.72W/3.72VA		1.72W/3.72VA		.86W/1.86VA	
Kelvin & Lumens	2700K - Warm White 82 lm, 100 lm/W	3000K - Pure White 86 lm, 102 lm/W	2700K - Warm White 82 lm, 100 lm/W	3000K - Pure White 86 lm, 102 lm/W	2700K - Warm White 41 lm, 50 lm/W	3000K - Pure White 43 lm, 51 lm/W



Name	Mini Step Light (without Louvers)		Vintage Park™		Decorative Hammered Roof	
SKU & Finish	15780 AZT27R	15780 AZT30R	15750 TZT27R	15750 TZT30R	15763 TZT27R	15763 TZT30R
Watt/VA	.86W/1.86VA		.86W/1.86VA		.86W/1.86VA	
Kelvin & Lumens	2700K - Warm White 41 lm, 50 lm/W	3000K - Pure White 43 lm, 51 lm/W	2700K - Warm White 41 lm, 50 lm/W	3000K - Pure White 43 lm, 51 lm/W	2700K - Warm White 41 lm, 50 lm/W	3000K - Pure White 43 lm, 51 lm/W



Name	Fundamentals™		Four Corners		Mini Deck Light	
SKU & Finish	16110 AZT27 16110 BKT27 16110 CO27 16110 GRY27 16110 SD27	16110 AZT30 16110 BKT30 16110 CO30 16110 GRY30 16110 SD30	16111 AZT27 16111 BKT27 16111 TZT27	16111 AZT30 16111 BKT30 16111 TZT30	15765 AZT27R 15765 CBR27 15765 BKT27R 15765 WHT27R	15765 AZT30R 15765 CBR30 15765 BKT30R 15765 WHT30R
Watt/VA	.86W/1.86VA		.86W/1.86VA		.86W/1.86VA	
Kelvin & Lumens	2700K - Warm White 41 lm, 50 lm/W	3000K - Pure White 43 lm, 51 lm/W	2700K - Warm White 41 lm, 50 lm/W	3000K - Pure White 43 lm, 51 lm/W	2700K - Warm White 41 lm, 50 lm/W	3000K - Pure White 43 lm, 51 lm/W



Also available with a Retrofit option

This compliments the full assortment of fixtures featuring our Centennial Brass finish

12V – Requires lamp



Name	Half Moon	
SKU & Finish	15764 AZT27R 15764 CBR27 15764 WHT27R	15764 AZT30R 15764 CBR30 15764 WHT30R
Watt/VA	.86W/1.86VA	
Kelvin & Lumens	2700K - Warm White 41 lm, 50 lm/W	3000K - Pure White 43 lm, 51 lm/W

Name	Brass Deck Retrofit Light	
SKU & Finish	15477 CBR	12V - Requires Lamp
LED Lamp Options	2W T5 Wedge (18120, 18121) Compares up to 16W Xenon 1.2W T5 Wedge (18198, 18199) Compares up to 10W Halogen	

# Lighting Techniques

## Deck & Patio Lighting

Accentuate all of the beauty and details of decks, patios, outdoor kitchens, steps, handrails and more.

*Recommended fixtures:*



*12V LED Half Moon 15764 (page 196)*







*12V LED Brick Light 15773 (page 196)*

## Want more Landscape Lighting Techniques?

Visit [Kichler.com/landscape](http://Kichler.com/landscape) for videos, or to view our 2018 Landscape full-line catalog.



LAMP	ITEM #	BASE/ LAMP TYPE	WATTS	KELVIN/LUMENS (lm for Bare Lamps)	BEAM ANGLE/ITEM #	
					120° Beam Angle	
	18122	<b>S8 Wedge*</b> Wet Location <b>W</b>	1.5W, 2.4VA	2700K - Warm White / 130 lm	18122	
	18123		Compares up to 18.5W Krypton	3000K - Pure White / 130 lm	18123	
	18120	<b>T5 Wedge*</b> Wet Location <b>W</b>	1.5W, 2.4VA	2700K - Warm White / 130 lm	18120	
	18121		Compares up to 16W Xenon	3000K - Pure White / 130 lm	18121	
	18124	<b>G4/T3 Bi-Pin*</b> Wet Location <b>W</b>	1.5W, 2.4VA	2700K - Warm White / 130 lm	18124	
	18125		Compares up to 20W Halogen	3000K - Pure White / 130 lm	18125	

LAMP	ITEM #	BASE/ LAMP TYPE	WATTS	KELVIN/LUMENS (lm for Bare Lamps)	BEAM ANGLE/ITEM #	
					180°	300°
	18198	<b>T5 Wedge</b> Mini Ceramic Wet Location <b>W</b>	1W, 1.2VA	2700K - Warm White / 85 lm	18198	--
	18199		Compares up to 10W Halogen	3000K - Pure White / 85 lm	18199	--
	18200	<b>T3/G4 Bi-Pin</b> Micro Ceramic Wet Location <b>W</b>	1W, 1.2VA	2700K - Warm White / 85 lm	18200	--
	18201		Compares up to 10W Halogen	3000K - Pure White / 85 lm	18201	--
	18204	<b>T5 Wedge</b> High Lumen Mini Wet Location <b>W</b>	2.3W, 3.3VA	2700K - Warm White / 215 lm	--	18204
	18205		Compares up to 20W Halogen	3000K - Pure White / 215 lm	--	18205
	18202	<b>S8 Wedge</b> High Lumen Mini Wet Location <b>W</b>	2.3W, 3.3VA	2700K - Warm White / 215 lm	--	18202
	18203		Compares up to 20W Halogen	3000K - Pure White / 215 lm	--	18203
	18206	<b>T3/G4 Bi-Pin</b> High Lumen Mini Wet Location <b>W</b>	2.3W, 3.3VA	2700K - Warm White / 215 lm	--	18206
	18207		Compares up to 20W Halogen	3000K - Pure White / 215 lm	--	18207
	18208	<b>BA15 Single Contact</b> High Lumen Mini Wet Location <b>W</b>	2.3W, 3.3VA	2700K - Warm White / 215 lm	--	18208
	18209		Compares up to 20W Halogen	3000K - Pure White / 215 lm	--	18209

LAMP	ITEM #	BASE/ LAMP TYPE	WATTS	KELVIN/LUMENS (lm for Bare Lamps)	BEAM ANGLE/ITEM #			
					15° SPOT	25° NARROW FLOOD	40° FLOOD	60° WIDE FLOOD
	18150, 18152, 18154, 18156	<b>MR8 BI-PIN</b> Damp Location <b>D</b>	2W, 3.1VA	2700K - Warm White 140 lm	18150	18152	18154	18156
	18151, 18153, 18155, 18157		Compares up to 15W Halogen	3000K - Pure White 150 lm	18151	18153	18155	18157
	18158, 18160, 18162, 18164	<b>MR11 BI-PIN</b> Damp Location <b>D</b>	2.5W, 3.8VA	2700K - Warm White 180 lm	18158	18160	18162	18164
	18159, 18161, 18163, 18165		Compares up to 20W halogen	3000K - Pure White 180 lm	18159	18161	18163	18165
	18126, 18128, 18130, 18132	<b>MR16</b> Damp Location <b>D</b>	4W, 5.4VA	2700K - Warm White 285 lm	18126	18128	18130	18132
	18127, 18129, 18131, 18133		Compares up to 20W halogen	3000 - Pure White 285 lm	18127	18129	18131	18133
	18134, 18136, 18138, 18140	<b>MR16</b> Damp Location <b>D</b>	5W, 6.6VA	2700K - Warm White 365 lm	18134	18136	18138	18140
	18135, 18137, 18139, 18141		Compares up to 35W halogen	3000K - Pure White 365 lm	18135	18137	18139	18141
	18142, 18144, 18146, 18148	<b>MR16</b> Damp Location <b>D</b>	7.2W, 9.9VA	2700K - Warm White 615 lm	18142	18144	18146	18148
	18143, 18145, 18147, 18149		Compares up to 50W Halogen	3000K - Pure White 615 lm	18143	18145	18147	18149
	18166, 18168, 18170, 18172	<b>PAR36</b> Wet Location <b>W</b>	4.2W, 6.3VA	2700K - Warm White 290 lm	18166	18168	18170	18172
	18167, 18169, 18171, 18173		Compares up to 20W Halogen	3000K - Pure White 290 lm	18167	18169	18171	18173
	18174, 18176, 18178, 18180	<b>PAR36</b> Wet Location <b>W</b>	6W, 8.5VA	2700K - Warm White 475 lm	18174	18176	18178	18180
	18175, 18177, 18179, 18181		Compares up to 35W Halogen	3000K - Pure White 475 lm	18175	18177	18179	18181
	18182, 18184, 18186, 18188	<b>PAR36</b> Wet Location <b>W</b>	10W, 13.2VA	2700K - Warm White 700 lm	18182	18184	18186	18188
	18183, 18185, 18187, 18189		Compares up to 50W Halogen	3000K - Pure White 700 lm	18183	18185	18187	18189
	18190, 18192, 18194, 18196	<b>PAR36</b> Wet Location <b>W</b>	14W, 19.2VA	2700K - Warm White 1090 lm	18190	18192	18194	18196
	18191, 18193, 18195, 18197		Compares up to 75W Halogen	3000K - Pure White 1090 lm	18191	18193	18195	18197

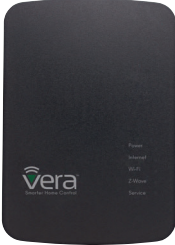

Name	Vera™ Edge	Vera™ Plus
SKU	16082 BK	16083 BK
Descr.	50-75 controllable devices; works with smartphone, tablet or computer. Wi-Fi compatible and works with Z-Wave® Plus.	75-125 controllable devices; works with smartphone, tablet or computer. Requires hardwire ethernet connection and works with Z-Wave® Plus.





# Low-Voltage Transformers



Name	Professional Series		Pro. Series	Pro. Series 2-in-1	Contractor Series	Contractor Series	
SKU & Finish	15PR100SS 15PR200SS 15PR300SS	15PR600SS 15PR900SS 15PR1200SS	15PR75SS	15PRD600SS	15CS75SS	15CS150SS 15CS300SS 15CS600SS	15CS900SS 15CS1200SS
Wattage	100W - 1200W		75W	600W	75W	150W - 1200W	
Descr.	Output voltage taps 12/13/14/15 Volts		Output voltage tap is 15 Volt only	Output voltage taps 12/13/14/15 Volts	Output voltage taps 12/15 Volts	Output voltage taps 12/13/14/15 Volts	



Name	Plus Series		Plus Series	Manual Series		Economy Series	In-Ground
SKU & Finish	15PL100AZT 15PL200AZT 15PL300AZT	15PL600AZT 15PL900AZT	15PL75AZT	15M100AZT 15M200AZT	15M300AZT 15M600AZT	15E60BK 15E120BK	15IGT100 15IGT300 15IGT600
Wattage	100W - 900W		75W	100W - 600W		60W, 120W	100W, 300W, 600W
Descr.	Output voltage taps 12/13/14/15 Volts		Output voltage tap is 15 Volt only	Output voltage taps 12 Volts only for 100W-200W. 12/13/15 Volts for 300W & 600W.		Output voltage tap is 12.5 Volts	Output voltage taps 12/13/14/15 Volts

## Transformer Accessories



Name	Mechanical Transformer Timer	Plug-in Transformer Photocell	Digital Transformer Timer	Plug-in Transformer Remote Photocell
SKU & Finish	15557 BK	15565 BK	15556 WH	15534 BK
Descr.	Plug-in timer suitable for outdoor temperatures when enclosed in an outdoor transformer enclosure.		Battery backup included. Straight-forward programming and easy daylight savings change over.	Plug-in photocell with 10' cord

Compatible with all Professional Series, Contractor Series and Plus Series transformers.

# Landscape Lighting

# Accessories – 12V

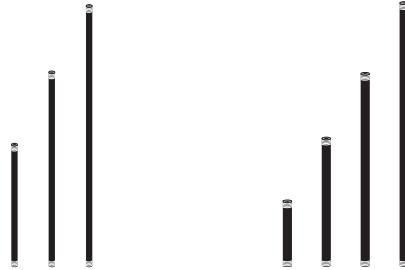
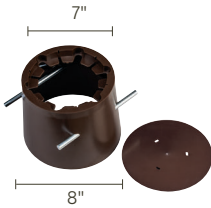

Name	Concrete Installation Kit	Fixture Mounting Stems 1/4-18 NPSM Thd. .5" Dia. Overall	Fixture Mounting Stems 1/2-14 NPSM Thd. .75" Dia. Overall	Adjustable Height Stems
SKU & Finish	16501 BBRP	15651 AZT, BKT 12" 15652 AZT, BKT 18" 15653 AZT, BKT 24"	15645 AZT, BKT 6" 15656 AZT, BKT 12" 15657 AZT, BKT 18" 15658 AZT, BKT 24"	15570 AZT, BKT
Notes	For use with fixtures 4W, 6.5W & 14W – 16030, 16031, 16032, 16033, 16034, 16035, 16036, 16037, 16038	1/2-14 NPSM stems will require additional Coupler (15649) or Elbow (15647) for accent light use	1/2-14 NPSM stems will require additional Coupler (15649) or Elbow (15647) for accent light use	1/2-14 NPSM stems will require additional Coupler (15649) or Elbow (15647) for accent light use. Extends from 18" to 33".

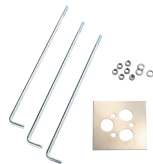

Name	Bollard Mounting Kit	Bollard Template Kit	Bollard Mounting Stake	Polymeric Support Stakes
SKU & Finish	15665 AZT, BKT 18" 15666 AZT, BKT 24" 15667 AZT, BKT 36"	15671 ST	15578 BK 23" H	15575 BK 8" H in-ground stake 15576 BK 14" H in-ground stake
Notes	For use with fixtures: 15005, 15011, 15205, 15211	For use with fixtures: 16130, 16131, 16132, 16133	For use with fixtures: 16130, 16131, 16132, 16133	



Name	Elbow	Stem Coupler	Surface Mounting Flange	Flange Mounting Nipple
SKU & Finish	15647 AZT, BKT	15649 AZT, BKT	15601 AZT, BKT, WHT	15602 AL
Notes	1.18" W x 2.09" H x 1.35" L	1.5" x 1/2-14 NPSM Thd. For use with .5" NPSM stems.	4" Dia. x 1/2-14 NPSM Thd.	1" x 1/2-14 NPSM Thd.



Name	Surface Mounting Bracket	Out of Water Bracket	Multi-Fixture Weighted Base	Single Fixture Weighted Base
SKU & Finish	15607 AZT, BKT, WHT	15777 SS	15776 BK	15778 BK
Notes	1.5" x 2.5" x 1" 1/2-14 NPSM Thd.	2.52" W For use with fixture: 15711 SS	3.375" W For use with fixture: 15711 SS	3.375" W For use with fixture: 15711 SS



Name	<b>Junction Box Mounting Bracket</b>	<b>Gutter Mount</b>	<b>3" Round Mounting Base</b>	<b>Male/Female Riser</b>
SKU & Finish	15609 AZT, BKT, WHT	15489 CBR	15493 CBR	15509 CBR 3" 15510 CBR 6" 15511 CBR 12" 15512 CBR 18" 15513 CBR 24"
Notes	2.39" W x 5.56" H	2.75" W x .75" H x 4" L		No couplers needed



Name	<b>90° Elbow</b>	<b>Two Fixture Mount</b>	<b>Surface/Tree Bracket</b>	<b>Amber Lens</b>
SKU & Finish	15514 CBR	15515 CBR	15516 CBR	16071 AMB For use with: 16015-16017 16072 AMB 16018-16020 15875 AMB 16150-16158
Notes	.5" W x .5" H x 2.75" L	2" W x 1" H x 2" L	1.5" W x 1.25" H x 6" L	For integrated LED fixtures

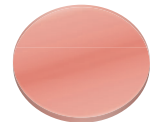

Name	<b>Green Foliage Lens</b>	<b>Frosted Lens</b>	<b>Frosted Lens</b>	<b>Red Lens</b>
SKU & Finish	16071 GRN For use with: 16015-16017 16072 GRN 16018-16020 15885 GRN 16150-16158	16071 FRO For use with: 16015-16017 16072 FRO 16018-16020 15895 FRO 16150-16158	15676 FRO For use with: 15092, 15384, 15484, 15494 15643 FRO 15374 16079 FRO 15361, 15861	16071 RD For use with: 16015-16017 16072 RD 16018-16020
Notes	For integrated LED fixtures	For integrated LED fixtures	For retrofit fixtures	For integrated LED fixtures



Name	<b>Holiday Green Lens</b>	<b>Blue Lens</b>	<b>Linear Lens</b>
SKU & Finish	16071 HGN For use with: 16015-16017 16072 HGN 16018-16020 15875 HGN 16150-16158	15631 BL For use with: 15398 15641 BL 15374 15673 BL 15382 15686 BL 15092, 15384, 15484, 15485, 15494 15693 BL 15397	15674 LIN For use with: 15382 15675 LIN 15092, 15384, 15484, 15494 15632 LIN 15398 15642 LIN 15374 15692 LIN 15381
Notes	For integrated LED fixtures	For retrofit fixtures	For retrofit fixtures

# Landscape Lighting

## Accessories – 12V



Name	Polycarbonate Lens		Heat-Resistant Lens		Small Long Cowl		Large Long Cowl	
SKU & Finish	<b>15695 CLR</b>	For use with: 15827 (Int. LED) 15315 (Retrofit)	<b>15659 AZT</b> <b>15689 BK</b>	For use with: 15079 15088, 15388	<b>16067 AZT, BKT, CBR</b>	For use with: 16015-16017	<b>16068 AZT, BKT, CBR</b>	For use with: 16018-16020
Notes					2.4" H		5.75" H	



Name	Small 360° Cowl		Large 360° Cowl		Long Cowl		Rock Guard - Polycarbonate	
SKU & Finish	<b>16069 AZT, BKT, CBR</b>	For use with: 16015-16017	<b>16074 AZT, BKT, CBR</b>	For use with: 16018-16020	<b>16076 AZT, BKT, CBR</b>	For use with: 16150-16158	<b>16051 BBRP</b>	For use with: 16030-16038
Notes	1.8" H		4.4" H		2.4" H			

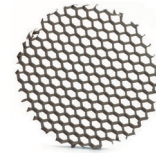

Name	Rock Guard		Rock Guard		Rock Guard - Solid Brass with Clear Lens		Hexcell Louver	
SKU & Finish	<b>15694 AZ</b>	For use with: 15194, 15268	<b>15690 BK</b>	For use with: 15088, 15388	<b>15482 CBR</b>	For use with: 15481	<b>15634 BK</b> <b>15644 BK</b> <b>15679 BK</b> <b>15680 BK</b> <b>15683 BK</b>	For use with: 15398 15374 15092, 15384, 15484, 15494 15381 15397
Notes	6.97" Dia., 1.29" H For retrofit fixtures		5.9" Dia., 1.686" H For retrofit fixtures		4.5" Dia., 1" H For retrofit fixtures		For retrofit fixtures	

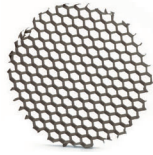

Name	Hexcell Louver	Hexcell Louver	Low-Voltage Cable	#14-2 Wire	#16-2 Wire		
SKU & Finish	16073 BK 16075 BK	For use with: 16015-16017 16018-16020	FM127265	For use with: 15810, 15811, 15826, 15839, 15850, 15870, 16120, 16121, 16125	15501 BK 100' 12-gauge 15502 BK 250' 12-gauge 15503 BK 250' 8-gauge 15504 BK 250' 10-gauge 15505 BK 500' 12-gauge 15506 BK 1000' 12-gauge	16088 BK	16089 BK
Notes	For integrated LED fixtures	For use with path lights utilizing the downward module			Now 14 and 16 gauge direct burial wire can now be used with the Kichler Lighting Design Pro LED Controller. Available in 250' EZ Pull boxes for added convenience. To be used only with the Kichler DesignPro LED Controller. See Kichler DC voltage drop calculator to calculate wire runs.		



Name	Gel-Filled Wire Connectors	QUIK DISC® Connector	Pro Series Wire Connector	Low-Voltage Power Conditioner (LVPC)	
SKU & Finish	15579 BK 15589 BK	8 & 10-gauge cable 12-gauge	15509 BK	15529 BL	16059 BK
Notes		For use with #12-2 or #10-2 low-voltage cable only	Bulk pack of 100 connectors, packed in sealed bags of 10	Master pack of 5	



Name	Landscape Flag Marker	Corrosion Preventative Compound
SKU & Finish	15507 ONG	15670 BK
Notes		

# Looking to reduce energy costs?

## Kichler Lighting offers many Energy Star® rated fixtures that can also be used to comply with 2016 Title 24, Part 6 High efficacy LED light source requirements.

As legislation changes and evolves, Kichler® makes sure our latest lineup of fixtures offer the features building owners are required to have.



### Energy Star®

Energy Star is a U.S. Environmental Protection Agency (EPA) voluntary program designed to help businesses and individuals save money and protect our climate through superior energy efficiency. Energy Star products are independently tested and certified to save energy without sacrificing features or functionality, including light quality or output. Lighting products covered include:

- Residential light fixtures and ceiling fans with light kits
- Commercial accent lights including line-voltage directional track lights
- Commercial downlights: recessed, pendant, surface mount (includes retrofits & excludes troffers or linear forms)
- Commercial under cabinet lighting

For more information, visit [www.energystar.gov](http://www.energystar.gov).



### Title 24 (T24)

Title 24 Building Energy Efficiency Standards are designed to reduce energy consumption by mandating that commercial building owners and homeowners use only high-efficacy lamps in both indoor and outdoor fixtures installed during new construction or remodels. The legislation has evolved recently to outline several new requirements for these fixtures, including:

- Light sources must offer "low flicker operation" (an LED must flicker less than 30% at frequencies below 200 Hz).
- LED lamps and luminaires must provide an R9 of at least 50.
- The Color Rendering Index must be equal to or greater than 90, assuring it produces strong, vibrant reds.

California is paving the way to reduce its greenhouse gas emissions to 1990 levels by 2020, and many additional municipalities nationwide have adopted these regulations as well. **All Kichler fixtures featuring the T24 logo meet the latest legislation requirements, including those implemented in January 2017 with JA8.**

For more information, visit [www.energy.CA.gov/title24](http://www.energy.CA.gov/title24) or [www.title24express.com](http://www.title24express.com).



## The DesignLights Consortium (DLC)

The DesignLights Consortium® is a non-profit organization that promotes quality, energy-efficient commercial-sector lighting solutions. The high-performance standards of a DLC qualified product are established in collaboration with its federal, regional, state, utility, and energy efficiency program members, manufacturers, lighting designers, and other industry stakeholders throughout the US and Canada. The goal is to identify quality products and program benefits that advance the industry-wide adoption of energy solutions throughout commercial construction. The DLC reviews:

- Non-residential fixtures not currently covered under the Energy Star program, such as: LED Luminaires like Outdoor Pole, Bollards, Landscape Accent and Flood, Wall Wash and garage canopies.
- Commercial lighting for industry applications like: Roadway, Parking garages – primarily outdoor, high-voltage applications
- 3rd party data to ensure fixtures meet stringent output, efficacy, CCT, CRI and warranty standards

For more information, visit [www.designlights.org](http://www.designlights.org).

## Lighting Facts

Although this program no longer exists [March 2018], it's important to have an understanding of its purpose. LED Lighting Facts is a program formerly sponsored by the U.S. Department of Energy that showcased the general illumination of LED products in accordance with the industry standard test method, IES LM-79-2008 (see below/next page). The label is an indication of manufacturers who have committed to testing products and reporting performance results according to these industry standards. The LED Lighting Facts label then allows Lighting Pros to review the characteristics of an LED product using accurate and verified performance data. There are still over 70,000 products in circulation which feature a Lighting Facts label.

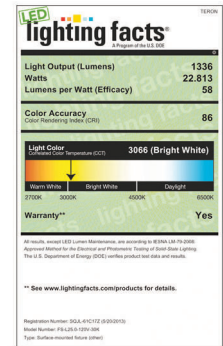

## Illuminating Engineering Society Of North America (IESNA) Lm-79-2008

IESNA developed a standardized industry test conducted on all LED light fixtures and light sources to provide universally consistent data that is translated for the benefit of end users. The test measures qualities such as lumens, energy consumed, CRI and color temperature – resulting in an IES file/report. It allows for a true comparison of energy efficiency regardless of the light source and serves as the primary source of data when creating Lighting Facts® labels. IES files are then also utilized by the design community to plot accurate light distribution throughout their plans.

For more information, visit [www.ies.org](http://www.ies.org).

# Looking to reduce energy costs?



## LEED®

The LEED® (Leadership in Energy & Environmental Design) certification program from the U.S. Green Building Council has become the benchmark for architects, real estate professionals, facility managers, engineers, interior designers, landscape architects, construction managers and government officials who want to design, construct and operate more sustainable buildings. The third-party certification process assigns LEED® points for products and processes used that promote green practices related to site development, water savings, energy efficiency, materials selection and indoor environmental quality. There are a limited number of possible points available, with a tiered system that certifies buildings with a Platinum, Gold, Silver or Certified status based on points earned. According to [leed.usgbc.org/leed](http://leed.usgbc.org/leed), from 2015-2018 LEED-certified buildings are estimated to generate as much as \$1.2 billion in energy savings and \$715.3 million in maintenance. The right lighting can contribute to earning LEED points in new construction.

For more information, visit [www.USGBC.org/leed](http://www.USGBC.org/leed).



## ICC

The International Code Council is a member-focused association. It is dedicated to developing model codes and standards used in the design, build and compliance process to construct safe, sustainable, affordable and resilient structures. Most U.S. communities and many global markets follow the International Codes, or I-Codes, published by ICC. The I-Codes are a complete set of comprehensive, coordinated building safety and fire prevention codes that provide minimum safeguards for people at home, at school and in the workplace. For instance, when a light fixture is to be placed in a ceiling filled with insulation, it requires an insulated contact (IC) rating to assure the fixture can be covered with insulation.

For more information, visit [www.iccsafe.org](http://www.iccsafe.org).





## FCC

Part 15 of the FCC regulations addresses the Radio Frequency (RF) of LED lighting products to ensure that devices do not cause harmful interference to radio-communications services. In most cases, the driver paired with LED lighting devices operates at RF frequencies similar to those used in digital electronic products. LED fixtures are then subject to the “Verification” or “Certification” equipment authorization procedures. The testing limits radiated emission from 30 MHz to 1000 MHz to ensure overall compliance with radiated emissions requirements. Manufacturers are required to design to these standards, as well as keep validated test reports on file. Wireless or “intentional” devices require reporting be submitted through the FCC.

For more information, visit [www.fcc.gov](http://www.fcc.gov).



## International Dark Sky Association (IDA)

IDA's Fixture Seal of Approval program certifies outdoor lighting fixtures as being Dark Sky Friendly, meaning that they minimize glare while reducing light trespass and sky glow. Dark Sky friendly fixtures are designed to reduce light pollution by directing the light down and out, not up. To earn the seal of approval, products are required to be fully shielded and to minimize the amount of blue light in the nighttime environment.

For more information, visit [www.darksky.org](http://www.darksky.org).



## ADA Compliant

The Americans with Disabilities Act is a federal anti-discrimination statute designed to ensure equal access to opportunities and benefits for qualified individuals with disabilities. The act seeks to remove barriers to the enjoyment of programs and employment opportunities, independent living, and economical self-sufficiency enjoyed by those without disabilities. The American with Disabilities Act (ADA) limits wall-mounted luminaires to four inches in depth when located between 27 inches and 84 inches from the finished floor level of walks, halls, corridors, passageways, or aisles. Many Kichler Lighting sconces meet this requirement at any mounting height.

For more information, visit [www.ada.gov](http://www.ada.gov).

# Navigating the Light



Color	<p><b>Color Correlated Temperature (CCT):</b> Also referred to as Color Temperature and displayed as Kelvin Temperature</p>	<p><b>Kelvin Temperature (K)</b> indicates the color of the light source or the color you are getting from an LED fixture</p> <ul style="list-style-type: none"> <li>• 2700K is a warmer light—closer to incandescent</li> <li>• 3000K trends warm, but optically closer to a pure white</li> <li>• 4000K trends cooler, but perceived as a bright white</li> <li>• 5000K is cool, perceived often as having a blue hue</li> </ul>
	<p><b>Color Rendering Index (CRI):</b> Particularly of importance indoors where there is less natural light</p>	<p><b>CRI</b> reflects the color that the light brings out of objects</p> <ul style="list-style-type: none"> <li>• 90+ CRI results in a more vibrant and “true” color</li> <li>• A lower CRI (&lt;80) would make seemingly colorful objects appear dull and unappealing.</li> </ul>
Brightness	<p><b>Lumens (lm):</b> Reflect the amount of light from a fixture</p>	<ul style="list-style-type: none"> <li>• The higher the lumens, the more light you are getting</li> <li>• Lumens in the lower 100s (&lt;550) typically work best for accent or niche lighting</li> <li>• 550 to 850 lumens give light levels equivalent to traditional 40W or 60W incandescent bulbs respectively, and are ideal for downlighting</li> <li>• 850 to 2000 lumens typically work best in spaces with average ceiling height (9' to 12')</li> <li>• 3000 to 5000 lumens are typically best for larger spaces, vaulted ceilings, and more task driven applications that require significant light</li> </ul>
Light Delivery	<p><b>Delivered Lumens</b></p>	<p>You may see <b>delivered lumens</b> throughout this catalog as we work diligently to provide that level of data</p> <ul style="list-style-type: none"> <li>• Source lumens = the brightness at the source</li> <li>• Delivered lumens = the brightness recognized closer to eye level, or the level in which the light has the most impact in a space</li> </ul>
	<p><b>Beam Spread</b></p>	<p><b>Beam spread</b> is an excellent indicator of how wide the light is being dispersed</p> <ul style="list-style-type: none"> <li>• Lower beam spread (60–80 degrees) is indicative of a thinner stream of light—similar to that of a flash light. This is often preferred for task lighting as it offers a stronger stream of light down to the task at hand.</li> <li>• Higher beam spread (100+) is wider—best suited for ambient or general purpose lighting across a room. The light is dispersed broadly, but has less strength as it goes down.</li> </ul>
Efficiency	<p><b>Lumens per watt (LPW):</b> also referred to as efficacy</p>	<p><b>LPW</b> reflects how many lumens you get per watt—which is a sign of efficiency. Energy Star® standards for indoor fixtures vary based on size and watt criteria:</p> <ul style="list-style-type: none"> <li>• &gt; 50 LPW for all lamp types below 30 total listed lamp watts</li> <li>• &gt; 60 LPW for all lamp types that are &lt; 24 inches and &gt; 30 total listed lamp watts</li> <li>• &gt; 70 LPW for all lamp types that are &gt; 24 inches and &gt; 30 total listed lamp watts</li> </ul>

Bring it all together.



Low-Profile LED Downlight  
3000K  
(43846WHLED30)



4U Series LED 12" Under  
Cabinet 3000K  
(4U30K12BZT, 6UCORDBK)



Shailene  
Wall Sconce  
(45572NI)



Shailene  
Mini Chandelier  
(43670NI)

1C1 BK, WH	107	1TEK1DWSF8SIL	109	6HS27K12AL	99	8T1010S22WH	97
1C1RGB BK, WH	107	1TEK1STRC2SIL	109	6HS30CLIPS	99	8T1010S27WH	97
1DC2 BK, WH	106	1TEK1STRC4SIL	109	6HS30K06AL	99	8T1010S30WH	97
1DC3 BK, WH	106	1TEK1STRC8SIL	109	6HS30K12AL	99	8T1010S40WH	97
1DCSWITCH BK, WH	106	1TEK1STSF2SIL	109	6HS45CLIPS	99	8T1010S50WH	97
1DDTRIMALM	100	1TEK1STSF4SIL	109	6HS50K06AL	99	8T1010U22WH	97
1DDTRIMBK	100	1TEK1STSF8SIL	109	6HS50K12AL	99	8T1010U27WH	97
1DDTRIMBW	100	1TEK1SWSF2SIL	109	6T1100H27 BK, WH	93	8T1010U30WH	97
1DDTRIMWH	100	1TEK1SWSF4SIL	109	6T1100H30 BK, WH	93	8T1010U40WH	97
1IC02 BK, WH	107	1TEK1SWSF8SIL	109	6T1100H50 BK, WH	93	8T1010U50WH	97
1IC02RGB BK, WH	107	2C1 WH	107	6T1100S27 BK, WH	93	8T1033H22WH	97
1IC06 BK, WH	107	2IC02 WH	107	6T1100S30 BK, WH	93	8T1033H27WH	97
1IC12 BK, WH	107	2IC06 WH	107	6T1100S50 BK, WH	93	8T1033H30WH	97
1IC12RGB BK, WH	107	2IC12 WH	107	6T110H27 BK, WH	93	8T1033H40WH	97
1IC36 BK, WH	107	2SL2 WH	106	6T110H30 BK, WH	93	8T1033H50WH	97
1IC36RGB BK, WH	107	2SL8 WH	106	6T110S27 BK, WH	93	8T1067S22WH	97
1IC96 BK, WH	107	2SLW2 WH	106	6T110S30 BK, WH	93	8T1067S27WH	97
1IC96RGB BK, WH	107	2SLW8 WH	106	6T110UH27 BK, WH	93	8T1067S30WH	97
1SL2 BK, WH	106	4D12V27 BKT, BZT, NIT, WHT	98	6T110UH30 BK, WH	93	8T1067S40WH	97
1SL2RGB BK, WH	106	4D12V30 BKT, BZT, NIT, WHT	98	6T110UH50 BK, WH	93	8T1067S50WH	97
1SL8 BK, WH	106	4DD12V040WH	100, 101	6T116S24 BK, WH	93	8T1100H22WH	97
1SL8RGB BK, WH	106	4DD12V060WH	100, 101	6T116S27 BK, WH	93	8T1100H27WH	97
1SLW2 BK, WH	106	4T1100H27 WH	92	6T116S30 BK, WH	93	8T1100H30WH	97
1SLW8 BK, WH	106	4T1100H30 WH	92	6T116S50 BK, WH	93	8T1100H40WH	97
1TEC130SF8SIL	109	4T1100H50 WH	92	6T120H24 BK, WH	93	8T1100H50WH	97
1TEC145SF8SIL	109	4T1100S27 WH	92	6T120H27 BK, WH	93	8T1100S22WH	97
1TEC1C1RC8SIL	108	4T1100S30 WH	92	6T120H30 BK, WH	93	8T1100S27WH	97
1TEC1DC1DW8SIL	108	4T1100S50 WH	92	6T120H50 BK, WH	93	8T1100S30WH	97
1TEC1DC2DW8SIL	108	4T116H27 WH	92	6T210H24 WH	94	8T1100S40WH	97
1TEC1DWRC8SIL	109	4T116H30 WH	92	6T210S24 WH	94	8T1100S50WH	97
1TEC1DWSF8SIL	109	4T116H50 WH	92	6T216S24 WH	94	8T11TF1WH	96
1TEC1FLRC8SIL	108	4T116S27 WH	92	6T220H24 WH	94	8T11TF2WH	96
1TEC1IC1DW8SIL	108	4T116S30 WH	92	6TD24V10BKT	101	8T11TF3WH	96
1TEC1IC2DW8SIL	108	4T116S50 WH	92	6TD24V40BKT	101	8T11TF4WH	96
1TEC1RDSF8SIL	108	4TD12V40BKT	101	6TD24V60BKT	101	8T11TR1WH	96
1TEC1SKSF8SIL	108	4TD12V60BKT	101	6TD24V96BKT	101	8T11WF1WH	96
1TEC1STRC8SIL	109	4TP12V30BK	101	6UCORD BK, WH	88	8T11WR1WH	96
1TEC1STSF8SIL	109	4TP12V60BK	101	6UCSK08 BZT, NIT, WHT	87	8T11WRSWH	96
1TEC1SWRC8SIL	109	4U27K08 BZT, WHT	86	6UCSK12 BZT, NIT, WHT	87	15CS1200SS	201
1TEC1SWSF8SIL	109	4U27K12 BZT, WHT	86	6UCSK22 BZT, NIT, WHT	87	15CS150SS15	201
1TEC2DMRC8SIL	108	4U27K22 BZT, WHT	86	6UCSK30 BZT, NIT, WHT	87	15CS300SS	201
1TEC2DWRC8SIL	109	4U27K30 BZT, WHT	86	8T1000H22WH	97	15CS600SS	201
1TEC2DWSF8SIL	109	4U30K08 BZT, WHT	86	8T1000H27WH	97	15CS75SS	201
1TEC2M1SF8SIL	108	4U30K12 BZT, WHT	86	8T1000H30WH	97	15CS900SS	201
1TEC2M2SF8SIL	108	4U30K22 BZT, WHT	86	8T1000H40WH	97	15E120BK	201
1TEC2S1SF8SIL	108	4U30K30 BZT, WHT	86	8T1000H50WH	97	15E60BK	201
1TEC2SMRC8SIL	108	5W14G250 WH	104	8T1000S22WH	97	15IGT100	201
1TEC2STRC8SIL	109	5W14G500 WH	104	8T1000S27WH	97	15IGT300	201
1TEC2STSF8SIL	109	5W16G250 WH	104	8T1000S30WH	97	15IGT600	201
1TEC2W1RC8SIL	108	5W16G500 WH	104	8T1000S40WH	97	15M100AZT	201
1TEC2W2RC8SIL	108	5W18G250 WH	104	8T1000S50WH	97	15M200AZT	201
1TEC3DWRC8SIL	109	5W18G500 WH	104	8T1001H22WH	97	15M300AZT	201
1TEC3DWSF8SIL	109	5W24G250 BK, WH	104	8T1001H27WH	97	15M600AZT	201
1TEC3SWSF8SIL	109	6D24V27 BKT, BZT, NIT, WHT	98	8T1001H30WH	97	15PL100AZT	201
1TEC4SF8SIL	108	6D24V30 BKT, BZT, NIT, WHT	98	8T1001H40WH	97	15PL200AZT	201
1TEC4TRSF8SIL	108	6DD24V060WH	100, 101	8T1001H50WH	97	15PL300AZT	201
1TEC4W3RC8SIL	108	6DD24V100WH	100, 101	8T1001S22WH	97	15PL600AZT	201
1TEC6EMRC8SIL	108	6HS0CLIPS	99	8T1001S27WH	97	15PL75AZT	201
1TEK145SF2SIL	109	6HS1IC02 WH	99	8T1001S30WH	97	15PL900AZT	201
1TEK145SF4SIL	109	6HS1IC06 WH	99	8T1001S40WH	97	15PR100SS	201
1TEK145SF8SIL	109	6HS1IC12 WH	99	8T1001S50WH	97	15PR1200SS	201
1TEK1DWRC2SIL	109	6HS1IC36 WH	99	8T1010H22WH	97	15PR200SS	201
1TEK1DWRC4SIL	109	6HS1IC96 WH	99	8T1010H27WH	97	15PR300SS	201
1TEK1DWRC8SIL	109	6HS1SL8 WH	99	8T1010H30WH	97	15PR600SS	201
1TEK1DWSF2SIL	109	6HS1SL8DC WH	99	8T1010H40WH	97	15PR75SS	201
1TEK1DWSF4SIL	109	6HS27K06AL	99	8T1010H50WH	97	15PR900SS	201

15PRD600SS	201	3681 NI, OZ	72	6322 NI, TZ	52, 78	9654 BK, TZ, WH	152
120RGB BK, WH	95	3681 NI, OZ, NIL18, OZL18	24	6323 NI, TZ	52, 78	9655 BK, TZ	152
206 NI, OZ, WH	30	3694 NI, NIW, OZ, OZW, NIWL18, OZWL18	25	6324 NI, TZ	52, 78	9707 OZLED	136
208 WH	30	3694 NI, OZ	72, 79	6520 NI, OZ	38	9708 OZLED	136
209 NI, OZ, WH	30	3694 NIW, OZW	75	6719 NI, TZ	39, 78	9709 OZLED	136
210 WH	30	3718 NI	26	7003 NI	30	9735 BK, TZ	149
216 WH	31	3797 CH, NI, OZS	71	7260 WH	31	9736 BK, TZ	149
21C36 WH	107	3797 CH, NI, OZS, CHL18, NIL18, OZL18	24	8043 NI, OZS	71	9774 BK, BKS, WH	149
21C96 WH	107	4145LED	15	8043 NI, OZS, NIL18, OZSL18	25	9776 BK, BKS, WH	149
345 BK, TZ	153	4146LED	15	8064 NI, TZ	28, 78	9777 BK, WH	149
365 BK	153	4300	155	8065 NI	28	9783 OZ	150
401 NI, SBK, SNB, WH	128	4301	155	8065 NI, TZ	78	9784 OZ	150
402 NI7, SNB, WH1	125	4302	155	8102 WH	31	9785 OZ	150
403 NI7, SNB, WH	125	4303	155	8108 NI, OZ, TZ	28	9788 BK, TZ	151
404 NI7, SNB, WH	125	4304	155	8109 NI, OZ, TZ	29	9789 BK, TZ	151
623 CH, NI	54	4305	155	8110 NI, OZ, TZ	29	9790 BK, TZ	151
624 CH, NI	54	4306	155	8111 CH, NI, OZ, WH	29	9791 BK, TZ	151
625 CH, NI	54	4307	155	8112 CH, NI, OZ, WH	29	9794 BK, TZ, BKL18, TZL18	137
626 CH, NI	54	4308	155	8112 NILED, OZLEDR	22	9848 BK, RZ	148
628 CH, NI	54	4309	155	8116 CH, NI, OZ, WH	29	9850 BK, TZ	153
1148 BK, TZ, WH	154	4310	155	8116 NILED, OZLEDR	22	9859 BK, TZ	153
1748 NI	71	4355 CLR	155	8206 NI	31	9886 BK, TZ	153
1781 NI, OZ	72	4381	155	8209 NI	31	9909 OZLED	136
1783 NI, OZ	72	5003 CH, NI, TZ	54	8404 NI	27	9918 BK, TZ	150
1788 NI, OZ	72	5017 CH, NI, TZ	54	8405 NI, TZ	28	9935 BK, TZ, BKL18, TZL18	137
1894 NI, OZS	71	5018 CH, NI, TZ	54	8406 NI	28	9938 BK, RZ	148
1896 AP, NI, OZS	71	5019 CH, NI, TZ	54	8407 NI	28	9940 BK, RZ	148
2019 NI, TZ	78	5096 NI, OZS	71	8653 NI, TZ	29	9956 BK, TZ	152
2020 AB, NI, TZ	78	5096 NI, OZS, NIL18, OZSL18	37	8654 NI, TZ	29	9985 OZ	150
2021 NI, TZ	78	5097 CH, NI, OZS	71	8655 NI, TZ	29	9992 BK, TZ	151
2076 NI, OZ	79	5097 CH, NI, OZS, NIL18, OZSL18	44	8880 NI	30	10041 WH	89
2093 NI, OZ	79	5098 CH, NI, OZS	71	8881 NI, OZ, WH, NIL18, OZL18, WHL18	25	10042 WH	89
2621 NI	144	5098 CH, NI, OZS, NIL18, OZSL18	44	8882 NI	30	10043 WH	89
2664 OZ, PN	62	5099 CH, NI, OZS	71	9021 BK, NI, OZ	144	10044 WH	89
2665 OZ, PN	67	5099 CH, NI, OZS, NIL18, OZSL18	71	9022 BK, NI, OB, OZ, WH	144	10082 FST	89
2666 OZ, PN	67	5099 CH, NI, OZS, NIL18, OZSL18	44	9023 BK, NI, OB, OZ	144	10083 FST	89
2693 NI, OZ	64	5294 NI, OZ	39, 79	9028 BK, TZ	150	10084 FST	89
2693 NI, OZ	79	5336 CHS, NIS, TZS	53	9029 BK, TZ	150	10170 BK, WH	110
2702 NI, TZ	68	5337 CHS, NIS, TZS	53	9030 BK, TZ	150	10171 BK, WH	110
2713 NI, OB	67, 144	5338 CHS, NIS, TZS	53	9032 BKT, RZ	146	10172 BK, WH	110
2771 NI, TZ	64	5339 CHS, NIS, TZS	53	9033 BKT, RZ	146	10173 BK, WH	110
2771 NI, TZ	78	5388 NI, OZ	72	9034 BKT, RZ	146	10174 BK, WH	110
3122 NI, NIA, TZ	26	5388 NI, OZ, NIL18, OZL18	37	9035 BKT, RZ	146	10175 BK, WH	110
3277 NI, OZ	68	5389 NI, OZ	72	9039 BK, RZ	148	10176 BK, WH	110
3277 NI, OZ	79	5389 NI, OZ, NIL18, OZL18	44	9040 BK, RZ	148	10177 BK, WH	110
3293 NI, OZ	79	5389 NI, OZS5389 NIL18, OZL18	44	9041 BK, RZ	148	10178 BK, WH	110
3299 NI, OZ, NIL18, OZSL18	60	5390 NI, OZ	72	9042 BK, RZ	148	10179	110
3299 NI, OZS	71	5390 NI, OZ, NIL18, OZSL18	44	9043 BK, RZ	148	10181	94
3345 NI	64	5391 NI, OZ	72	9044 NI	144	10183	94
3345 NI	71	5391 NI, OZS5391, NIL18, OZL18	44	9095 AZ	154	10189 BK, WH	106
3348 NI	26, 68, 71	5447 CH, NI, OZ	50, 71	9142 BK, NI, OZ	144	10190BK30	101
3349 NI	68, 71	5448 CH, NI, OZ	50, 71	9234 AZ, BA, BK, WH	154	10190BK48	101
3384 NI, OZ	72	5449 CH, NI, OZ	50, 71	9236 AZ	154	10190BK60	101
3384 NI, OZ, NIL18, OZL18	60	5991 CH, NI, OZ	39, 79	9244 AZ, BA, BK, WH	154	10198 BK, WH	106
3476 NI, OZ	64	5992 CH, NI, OZ	52, 79	9246 AZ, BA, BK, WH	154	10301 WH, WHLED	23
3476 NI, OZ	79	5993 CH, NI, OZ	52, 79	9320 BK, WH	153	10303 WH, WHLED	23
3482 NI, OZ	72	5994 CH, NI, OZ	52, 79	9322 BK, WH	153	10315 WH, WHLED	23
3482 NI, OZ, NIL18, OZL18	59	6040 AZ, NI	154	9532 BKT, RZ	146	10421 SNLED	35
3497 NI, OZ, NIL18, OZSL18	59	6048 AZ, NI	154	9533 BKT, RZ	146	10438 NCHLED	35
3497 NI, OZS	71	6052 AZ, WH	154	9538 BKT, RZ	146	10439 NCHLED	35
3502 NI, TZ	68, 78	6121 CH, NI	39	9611 BK, OZ, SS, TZ, WH	153	10570 BK, WH	88
3620 NI	27	6122 CH, NI	53	9618 OZ	152	10571 BK, WH	88
3623 NI, OZ, TZ	26	6123 CH, NI	53	9618 SS	153	10572 BK, WH	88
3623 NI, TZ	78	6124 CH, NI	53	9650 BK, TZ, WH	152	10573 BK, WH	88
3627 NI, OZ	27			9653 BK, TZ, WH	152	10588	89

10588 SI	88	12664 ALM, AZ, NI, WH	114	15507 CBR	190	15676 FRO	203
10589	89	12665 ALM, AZ, NI, WH	114	15508 CBR	205	15679 BK	204
10589 SI	88	12666 ALM, AZ, NI, WH	115	15509 BK	205	15680 BK	204
10620 NILED	35	12667 ALM, AZ, NI, WH	115	15509 CBR	203	15683 BK	204
10630 PNLED	36	12668 ALM, AZ, NI, WH	115	15510 CBR	203	15686 BL	203
10755 WHLED	22	12672 ALM, AZ, NI, WH	114	15511 CBR	203	15688 AZ	175
10760 WHLED	22	12673 ALM, AZ, NI, WH	114	15512 CBR	203	15689 BK	204
10761 WHLED	22	12674 ALM, AZ, NI, WH	114	15513 CBR	203	15690 BK	204
10763 NILED	21	12675 ALM, AZ, NI, WH	114	15514 CBR	203	15692 LIN	203
10764 NILED	21	12676 ALM, AZ, NI, WH	115	15515 CBR	203	15693 BL	203
10765 NILED	21	12677 ALM, AZ, NI, WH	115	15516 CBR	203	15694 AZ	204
10766 WHLED	22	12678 ALM, AZ, NI, WH	115	15517 CBR	186	15695 CLR	204
10767 WHLED	22	15194 AZ	190	15529 BL	205	15711 SS27, SS, SS42	188
10768 WHLED	22	15205 AZT, BKT	171	15534 BK	201	15716 SS	195
10769 NILED, OZLED	20	15211 AZT, BKT	171	15556 WH	201	15717 SS	195
10784 NILED, OZLED	20	15230 AZT	170	15557 BK	201	15718 SS	195
10786 NILED, OZLED	20	15231 AZT, BKT	170	15565 BK	201	15719 SS	195
10788 NILED, OZLED	20	15232 AGZ	171	15570 AZT, BKT	202	15734 AZT30, BBR30, CO30, GRY30, SD30, WHT30	195
10789 NILED, OZLED	20	15236 BKT, TZT	171	15575 BK	202	15735 AZT30, BBR30, CO30, GRY30, SD30, WHT30	195
10790 NILED, OZLED	36	15239 OZ	171	15576 BK	202	15736 AZT30, BBR30, CO30, GRY30, SD30, WHT30	195
10795 NILED	36	15241 AZT, BKT	170	15578 BK	175, 202	15744 AZT27, BBR27, CO27, GRY27, SD27, WHT27, AZT30, BBR30, CO30, GRY30, SD30, WHT30	194
10797 NILED	36	15250 AZT	170	15579 BK	205	15745 AZT27, BBR27, CO27, GRY27, SD27, WHT27, AZT30, BBR30, CO30, GRY30, SD30, WHT30	194
10798 NILED	41	15251 AZT, BKT	170	15589 BK	205	15746 AZT27, BBR27, CO27, GRY27, SD27, WHT27, AZT30, BBR30, CO30, GRY30, SD30, WHT30	194
10799 NILED	41	15255 AZT	170	15601 AZT, BKT, WHT	174, 202	15750 TZT27R, TZT30R	196
10800 NILED	41	15266 AZ	170	15602 AL	175, 202	15755 AZT30, BBR30, CO30, GRY30, SD30, WHT30	195
10885 NILED	21	15268 AZ	170	15607 AZT, BKT, WHT	202	15756 AZT27, BBR27, CO27, GRY27, SD27, WHT27, AZT30, BBR30, CO30, GRY30, SD30, WHT30	194
10886 NILED	21	15276 BK	174	15608 AZ	175	15763 TZT27R, TZT30R	196
10923 BK, TZ	152	15295 AZ	170	15609 AZT, BKT, WHT	174, 203	15764 AZT27R, CBR27, WHT27R, AZT30R, CBR30, WHT30R	196
10954 TZ	152	15384 AZT, AZT24, BKT, BKT24, CBR, CO	186	15616 WH10	175	15765 AZT27R, CBR27, BKT27R, WHT27R, AZT30R, CBR30, BKT30R, WHT30R	196
11077 AZT, BKT	133	15470 AZT, BKT, CBR	193	15620 AZT, BKT	175	15773 AZT27R, AZT30R	196
11131 AZTLED	23, 135	15475 CBR	186	15623 BL	175	15774 AZT27R, AZT30R	196
11141 NILED	42	15476 CBR	186	15628 AZT, BKT	175	15776 BK	188, 202
11142 NILED	42	15477 CBR	196	15630 AZT	175	15777 SS	188, 202
11143 NILED	42	15478 CBR	193	15631 BL	203	15778 BK	188, 202
11144 NILED	42	15478 CBR	193	15632 LIN	203	15780 AZT27R, AZT30R	196
11146 NILED	43	15480 CBR	193	15634 BK	204	15782 AZT27R, CBR27, BKT27R, CO27R, WHT27R, AZT30R, CBR30, BKT30R, CO30R, WHT30R	196
11147 NILED	43	15481 CBR	190	15638 BK	175	15800 AZT27R, CBR27, AZT30R, CBR30	191
11148 NILED	43	15482 CBR	204	15640 AZT, BKT	175	15803 AZT27R, AZT30R	191
11149 NILED	43	15483 CBR	186	15641 BL	203	15805 BKT27R, BKT30R	191
11150 NILED	43	15484 CBR	186	15642 LIN	203	15806 BKT27R, BKT30R	191
11151 NILED	43	15485 CBR	186	15643 FRO	203	15810 AZT27R, CBR27, BKT27R, AZT30R, CBR30, BKT30R	192
11250 AZT30, BKT30	133	15486 CBR	186	15644 BK	204	15811 AZT27R, AZT30R	192
11251 AZT30, BKT30	133	15487 CBR	186	15645 AZT, BKT	174, 202	15815 AZT27R, BKT27R, AZT30R, BKT30R	191
11252 NILED	58	15489 CBR	203	15647 AZT, BKT	202	15820 AZT, CBR, CO, AZT27, CBR27, CO27	192
11253 NILED	43	15490 CBR	189	15648 AZT, BKT	175		
11254 NILED	43	15491 CBR	189	15649 AZT, BKT	202		
11255 NILED	43	15492 CBR	189	15650 AZT	175		
11301 NILED	58	15493 CBR	203	15651 AZT, BKT	202		
11302 CPLED, NILED	20	15495 CBR	189	15652 AZT, BKT	202		
11303 CPLED, NILED	21	15496 CBR	189	15653 AZT, BKT	202		
11304 NILED	23	15497 CBR	189	15656 AZT, BKT	174, 202		
11305 NILED	58	15498 CBR	189	15657 AZT, BKT	174, 202		
11309 BKTLED	133	15499 CBR	189	15658 AZT, BKT	174, 202		
11310 BKTLED	133	15500 CBR	187	15659 AZT	204		
11314 NILED	58	15501 BK	205	15660 AZT, BKT	175		
11315 NILED, OZLED	35	15501 CBR	187	15665 AZT, BKT	202		
11319 NILED, OZLED	35	15502 BK	205	15666 AZT, BKT	202		
11320 BKTLED	135	15502 CBR	193	15667 AZT, BKT	202		
12330 BK, WH	110	15503 BK	205	15668 AZT	175		
12600 AZ, WH	114	15503 CBR	193	15670 BK	205		
12602 AZ, WH	114	15504 BK	205	15671 ST	175, 202		
12604 AZ, WH	115	15504 CO	193	15673 BL	203		
12606 AZ, WH	115	15505 BK	205	15674 LIN	203		
12662 ALM, AZ, NI, WH	114	15505 CO	193	15675 LIN	203		
12663 ALM, AZ, NI, WH	114	15506 BK	205				
		15506 CBR	193				

15821 AZT2715821 CBR2715821 CO27	192	16151 AZT27, BKT27, CBR27, AZT30, BKT30, CBR30	182	16230 CBR30, CBR40, CBR50	167	18137	199
15826 AZT27R, BKT27R, AZT30R, BKT30R	191	16152 AZT27, BKT27, CBR27, AZT30, BKT30, CBR30	182	16231 AZT	156	18138	199
15827 CBR27, CBR30	191	16153 AZT27, BKT27, CBR27, AZT30, BKT30, CBR30	183	16234 AZT	156	18139	199
15833 AZT27R, AZT30R	191	16154 AZT27, BKT27, CBR27, AZT30, BKT30, CBR30	183	16235 AZT	156	18140	199
15839 CO27R, TZT27R, CO30R, TZT30R	191	16155 AZT27, BKT27, CBR27, AZT30, BKT30, CBR30	183	16236 AZT	156	18141	199
15843 CO27, TZT27, CO, TZT	191	16156 AZT27, BKT27, CBR27, AZT30, BKT30, CBR30	184	16237 AZT	156	18142	199
15857 AZT27R, AZT30R	192	16157 AZT27, BKT27, CBR27, AZT30, BKT30, CBR30	184	16238 AZT	156	18143	199
15861 AZT27R, BKT27R, AZT30R, BKT30R	185	16158 AZT27, BKT27, CBR27, AZT30, BKT30, CBR30	184	16243	157	18144	199
15870 AZT27R, CBR27, BKT27R, AZT30R, CBR30, BKT30R	192	16200 BBR30, BBR42	168	16244	157	18145	199
15871 CBR27, TZT27, CBR30, TZT	191	16201 BBR30, BBR42	168	16251	157	18146	199
15875 AMB	203	16202 BBR30, BBR42	168	16255	157	18147	199
15875 HGN	203	16203 BBR30, BBR42	168	16258 CBR30, CBR40, CBR50	167	18148	199
15885 GRN	203	16204 BBR30, BBR42	169	16280 AZT, BKT	174	18149	199
15895 FRO	203	16205 BBR30, BBR42	169	16281 AZT, BKT	174	18150	199
16015 AZT27, BKT27, CBR27, AZT30, BKT30, CBR30	180	16206 BBR30, BBR42	168	16282 AZT, BKT	174	18151	199
16016 AZT27, BKT27, CBR27, WHT27, AZT30, BKT30, CBR30, WHT30	180	16207 BBR30, BBR42	168	16283 AZT, BKT	174	18152	199
16017 AZT27, BKT27, CBR27, AZT30, BKT30, CBR30	180	16208 BBR30, BBR42	169	16284 AZT, BKT	174	18153	199
16018 AZT27, BKT27, CBR27, AZT30, BKT30, CBR30	181	16209 AZT30, BKT30, AZT40, BKT40	162	16285 AZT, BKT	174	18154	199
16019 AZT27, BKT27, CBR27, WHT27, AZT30, BKT30, CBR30, WHT30	181	16210 AZT30, BKT30, AZT40, BKT40	162	16286 AZT, BKT	174	18155	199
16020 AZT27, BKT27, CBR27, AZT30, BKT30, CBR30	181	16211 AZT30, BKT30, AZT40, BKT40	162	16287 AZT, BKT	174	18156	199
16051 BBRP	204	16212 AZT30, BKT30, AZT40, BKT40	162	16288 AZT, BKT	174	18157	199
16059 BK	205	16213 AZT30, BKT30, AZT40, BKT40	162	16289 AZT, BKT	174	18158	199
16070 AZT27R, BKT27R, CBR27R, AZT30R, BKT30R, CBR30R	185	16214 AZT30, BKT30, AZT40, BKT40	162	16290SS	167	18159	199
16071 AMB	203	16215 AZT30, BKT30, AZT40, BKT40	163	16501 BBRP	202	18160	199
16071 FRO	203	16216 AZT30, BKT30, AZT40, BKT40	163	18081	173	18161	199
16071 GRN	203	16217 AZT30, BKT30, AZT40, BKT40	163	18082	173	18162	199
16071 HGN	203	16218 AZT40, BKT40, AZT40, BKT40	163	18083	173	18163	199
16071 RD	203	16219 AZT40, BKT40, AZT40, BKT40	163	18084	173	18164	199
16072 AMB	203	16220 AZT40, BKT40, AZT40, BKT40	163	18085	173	18165	199
16072 FRO	203	16221 AZT30, BKT30, AZT30TR, BKT30TR, AZT30SL, BKT30SL, AZT40, BKT40, AZT40TR, BKT40, AZT40SL, BKT40SL	164	18086	173	18166	199
16072 HGN	203	16222 AZT30, BKT30, AZT30, BKT30TR, AZT30SL, BKT30SL, AZT40, BKT40, AZT40TR, BKT40TR, AZT40SL, BKT40SL	164	18087	173	18167	199
16072 RD	203	16223 AZT30, BKT30, AZT30, BKT30, AZT30SL, BKT30SL, AZT40, BKT40, AZT40TR, BKT40, AZT40SL, BKT40SL	165	18088	173	18168	199
16073 BK	205	16224 AZT30, BKT30, AZT30TR, BKT30TR, AZT30SL, BKT30SL, AZT40, BKT40, AZT40TR, BKT40TR, AZT40SL, BKT40SL	165	18089	173	18169	199
16074 AZT, BKT, CBR	204	16225 AZT30, BKT30, AZT30TR, BKT30TR, AZT30SL, BKT30SL, AZT40, BKT40, AZT40TR, BKT40TR, AZT40SL, BKT40SL	166	18090	173	18170	199
16075 BK	205	16227 CBR30, CBR40, CBR50	167	18091	173	18171	199
16076 AZT, BKT, CBR	204	16228 CBR30, CBR40, CBR50	167	18092	173	18172	199
16079 FRO	203			18093	173	18173	199
16082 BK	200			18094	173	18174	199
16083 BK	200			18095	173	18175	199
16088 BK	205			18096	173	18176	199
16089 BK	205			18097	173	18177	199
16110 AZT27, BKT27, CO27, GRY27, SD27, AZT30, BKT30, CO30, GRY30, SD30	196			18098	173	18178	199
16111 AZT27, BKT27, TZT27, AZT30, BKT30, TZT30	196			18111	173	18179	199
16120 AZT27, CBR27, BKT27, AZT30, CBR30, BKT30	191			18112	173	18180	199
16124 AGZ27, BKT27, CW27, AGZ30, BKT30, CW30	192			18113	173	18181	199
16130 AZT28, BKT28	192			18114	173	18182	199
16131 AZT28, BKT28	192			18115	173	18183	199
16132 AZT28, BKT28	192			18116	173	18184	199
16133 AZT28, BKT28	192			18120	198	18185	199
16150 AZT27, BKT27, CBR27, AZT30, BKT30, CBR30	182			18121	198	18186	199
				18122	198	18187	199
				18123	198	18188	199
				18124	198	18189	199
				18125	198	18190	199
				18126	199	18191	199
				18127	199	18192	199
				18128	199	18193	199
				18129	199	18194	199
				18130	199	18195	199
				18131	199	18196	199
				18132	199	18197	199
				18133	199	18198	198
				18134	199	18199	198
				18135	199	18200	198
				18136	199	18201	198

18202	198	43153 AP, MIZ	68, 80	43848 NILED27, NILED27T, OZLED27, OZLED27T, WHLED27, WHLED27T, WHLED27TB, NILED30, NILED30T, OZLED30, OZLED30T43848	15	44244 NILED30, WHLED30, NILED40, WHLED40	16
18203	198	43154 AP, MIZ	27, 80	43850 CH, NI, OZ	62	44245 NILED30, WHLED30, NILED40, WHLED40	16
18204	198	43155 NI, OZ	81	43851 NI, OZ	62	44246 NILED30, WHLED30, NILED40, WHLED40	16
18205	198	43156 NI, OZ	81	43852 NI, OZ	62	44247 NILED30, WHLED30, NILED40, WHLED40	17
18206	198	43158 NI, OZ	81	43853 CH, NI, OZ	62	44248 NILED30, WHLED30, NILED40, WHLED40	17
18207	198	43162 NI, OZ	81	43855 WHLED30T	14	44249 NILED30, WHLED30, NILED40, WHLED40	17
18208	198	43162 NI, OZ, NIL18, OZL18	59	43870 WHLED27, WHLED27B, WHLED30, WHLED30B	14	45054 NI, OZ	81
18209	198	43163 NI, OZ	81	43878 WHLED27	15	45054 NI, OZ, NIL18, OZL18	46
42141 CHCLR	66	43163 NI, OZ, NIL18, OZL18	60	43878 WHLED30	15	45055 NI, OZ	81
42141 NICS	66	43164 NI, OZ	81	43883 NILED30, OZLEDR	21	45055 NI, OZ, NIL18, OZL18	46
42141 OZCLR	66	43164 NI, OZ, NIL18, OZL18	60	43922 NI, OZ	75	45056 NI, OZ	81
42141 OZCS	66	43165 NI, OZ	67	43923 NI, OZ	75	45056 NI, OZ, NIL18, OZL18	46
42167 NIMER, OZMER	62	43169 NI, OZ	81	43925 NI, OZ	75	45358 BPT, CH, OZ	38, 72
42296 NI, OZ	28	43169 NI, OZ, NIL18, OZL18	24	43925 NI, OZ, NIL18, OZL18	25	45359 BPT, CH, OZ	49, 72
42372 NILED	33	43170 NI, OZ	81	43926 NI, OZ	75	45360 BPT, CH, OZ	49, 72
42379 NILED30, OZLEDR	21	43170 NI, OZ43170 NIL18, OZL18	37	43926 NI, OZ, NIL18, OZL18	25	45361 BPT, CH, OZ	49, 72
42380 NILED30, OZLEDR	21	43194 AP, MIZ	27, 80	43927 NI, OZ	75	45374 CH, NI, OZ	75
42436 AP, OZ	62	43223 NI, OZ	82	43927 NI, OZ, NIL18, OZL18	58	45375 CH, NI, OZ, CHL18, NIL18, OZL18	45
42437 AP, OZ	67	43224 NI, OZ	82	43927 NI, OZ, NIL18, OZL18	58	45376 CH, NI, OZ	75
42456 CHCLR	65	43224 NI, OZ	82	43937 NI, OZ	83	45376 CH, NI, OZ, CHL18, NIL18, OZL18	45
42456 OZCLR	65	43225 NI, OZ	82	43938 NI, OZ	83	45377 CH, NI, OZ	75
42456 OZCP	65	43227 NI, OZ	68, 82	43940 NI, OZ	67, 83	45377 CH, NI, OZ, CHL18, NIL18, OZL18	45
42475 CHCLR	65	43230 NI, OZ	64	43941 NI, OZ	83	45421 NI, OZ	39, 82
42475 NIMER	65	43230 NI, OZ	82	43941 NI, OZ, NIL18, OZL18	59	45422 NI, OZ	53, 82
42475 OZMER	65	43232 NI, OZ	26, 82	43949 CLP, NBR	63	45423 NI, OZ	53, 82
42500 PNLED	33	43391 AP, OZ	81	43953 NI, OZ	65	45424 NI, OZ	53, 82
42557 BPT, OZ	72	43392 AP, OZ	81	43954 NI, OZ	65	45449 AP, MIZ	39, 80
42561 BPT, OZ	68, 72	43394 AP, OZ	64	43955 NI, OZ	65	45450 AP, MIZ	51, 80
42562 BPT, OZ	63	43394 AP, OZ	81	43982 BK	66	45451 AP, MIZ	51, 80
42562 BPT, OZ	72	43503 NI, OZ	74	43984 BK	66	45452 AP, MIZ	51, 80
42563 BPT, OZ	26, 72	43504 NI, OZ	74	43992 AP, OZ	73	45495 CH, NI, OZ	38, 70
42588 NI, OZ	62	43504 NI, OZ	74	43993 AP, OZ	73	45496 CH, NI, OZ	70
42649 OZ	67	43511 NI, OZ, NIL18, OZL18	59	43994 AP, OZ	73	45497 CH, NI, OZ	70
42798 NI, OZ	63	43512 NI, OZ	74	43995 CH, NI, OZ	70	45498 CH, NI, OZ	70
42869 NI, OZ	66	43512 NI, OZ, NIL18, OZL18	24	43996 CH, NI, OZ	63	45504 NI, OZ	74
42877 NI, OZ	66	43594 BK	83	43996 CH, NI, OZ	70	45504 NI, OZ, NIL18, OZL18	37
42878 NI, OZ	62	43595 BK	83	43997 CH, NI, OZ	70	45512 NI, OZ	74
42878 NI, OZ	62	43596 BK	83	43998 CH, NI, OZ	67, 70	45512 NI, OZ45512 NIL18, OZL18	45
42879 NI, OZ	26, 78	43597 BK	83	43999 CH, NI, OZ	70	45513 NI, OZ	74
42880 NI, OZ	64	43637 NI, OZ	77	44029 NI, OZ	77	45513 NI, OZ, NIL18, OZL18	45
42880 NI, OZ	78	43637 NI, OZ	77	44030 NI, OZ	77	45514 NI, OZ	74
42881 NI, OZ	68, 78	43638 NI, OZ	77	44032 NI, OZ	63	45514 NI, OZ, NIL18, OZL18	45
42882 NI, OZ	68, 78	43640 NI, OZ	77	44032 NI, OZ	77	45568 NI, OZ	76
42883 NI, OZ	78	43640 NI, OZ, NIL18, OZL18	59	44033 NI, OZ	28, 77	45568 NI, OZ, NIL18, OZL18	37
42884 NI, OZ	78	43641 NI, OZ	77	44043 AUB	83	45569 NI, OZ	76
42890 NI, OZ	66	43641 NI, OZ, NIL18, OZL18	25	44044 AUB	83	45569 NI, OZ, NIL18, OZL18	45
42900 NI, OZ	82	43664 NI, OZ	76	44045 AUB	83	45570 NI, OZ	76
42900 NI, OZ, NIL18, OZL18	24	43665 NI, OZ	76	44050 NI, OZ	76	45570 NI, OZ, NIL18, OZL18	45
42901 NI, OZ	82	43668 NI, OZ	76	44051 NI, OZ	76	45571 NI, OZ	76
42901 NI, OZ, NIL18, OZL18	59	43668 NI, OZ, NIL18, OZL18	58	44053 NI, OZ	64	45572 CH, NI, OZ	38, 74
42902 NI, OZ	82	43669 NI, OZ	76	44053 NI, OZ	76	45573 CH, NI, OZ	49, 74
42902 NI, OZ, NIL18, OZL18	60	43669 NI, OZ, NIL18, OZL18	25	44054 NI, OZ	76	45574 CH, NI, OZ	49, 74
42903 NI, OZ	82	43670 NI, OZ	74	44058 OZ	63	45575 CH, NI, OZ	49, 74
42903 NI, OZ, NIL18, OZL18	60	43671 NI, OZ	74	44063 NI, OZ	73	45590 AP, OZ	38, 73
42905 NI, OZ	82	43674 NI, OZ	64	44064 NI, OZ	73	45591 AP, OZ	50, 73
42906 NI, OZ	82	43674 NI, OZ	74	44065 NI, OZ	63	45592 AP, OZ	50, 73
43073 NI, OZ	75	43675 NI, OZ	27, 74	44065 NI, OZ	73	45593 AP, OZ	50, 73
43074 NI, OZ	75	43691 NI, OZ	74	44066 NI, OZ	28, 73		
43076 NI, OZ	75	43691 NI, OZ	27	44196 MBK	63		
43076 NI, OZ, NIL18, OZL18	60	43692 NI, OZ	74				
43077 NI, OZ	75	43692 NI, OZ	27				
43077 NI, OZ, NIL18, OZL18	59	43693 NI, OZ	74				
43139 AP, MIZ	67, 80	43693 NI, OZ	27				
43149 AP, MIZ	80	43693 NI, OZ	27				
43152 AP, MIZ	63	43800 BKT	155				
43152 AP, MIZ	80	43846 WHLED27, WHLED27B, WHLED30, WHLED30B	15				



45595 AP, OZ	39, 81	45941 NI, OZ	83	49843 OZ	147	83997	55
45596 AP, OZ	51, 81	45941 NI, OZ, NIL18, OZL18	47	49844 OZ	147	83998	55
45597 AP, OZ	51, 81	49117 AZLED	134	49857 BKT	140	83999	55
45598 AP, OZ	51, 81	49118 AZLED	134	49858 BKT	140	84000	55
45637 CH, NI, OZ	77	49183 BK, TZ, BKL18, TZL18	137	49859 BKT	140	84003	55
45637 CH, NI, OZ, CHL18, NIL18, OZL18	37	49185 BK, TZ	151	49860 BKT	140	300026 BSS, OBB	122
45638 CH, NI, OZ	77	49186 BK, TZ, BKL18, TZL18	137	49861 BKT	140	300117 BSS, DBK, MWH, NI, OBB, WH	123
45638 CH, NI, OZ, CHL18, NIL18, OZL18	46	49187 BK, TZ, BKL18, TZL18	137	49882 DBK	142	300173 MWH, NBR, NI, OZ, PN, SBK, WH	119
45639 CH, NI, OZ	77	49190 AZLED	134	49883 DBK	142	300188 DBK, NI, OBB, WH	122
45639 CH, NI, OZ, CHL18, NIL18, OZL18	46	49255 BK, BKS, TZ, WH	149	49884 DBK	142	300206 BAP, OBB, TZ, WH	120
45640 CH, NI, OZ	77	49256 BK, BKS, WH	149	49885 DBK	142	300230 NI, OBB, WH	118
45640 CH, NI, OZ, CHL18, NIL18, OZL18	46	49278 AZTLED, PLLED	132	49892 OZ	145	300251 NI, OLZ, WH	120
45656 CHLED	33	49279 AZTLED, PLLED	132	49893 OZ	145	300457 AP, NI, OBB	121
45657 CHLED	41	49434 AZ, PL, SBK	33, 134	49894 OZ	145	310192 SBK, TZP, WCP, WH, WSP	128
45658 CHLED	41	49435 AZ, PL, SBK	33, 134	49895 OZ	145	310193 TZP, WSP	128
45679 CHLED, NILED	42	49436 AZ	33, 135	49917 BK	145	310206 MWH, WCP, WSP	126
45680 CHLED, NILED	42	49437 AZ	33, 135	49918 BK	145	310215 TZP, WSP	126
45682 CHLED	42	49444 AZ, BA	142	49919 BK	145	310220 OZ, WSP, WZC	126
45683 CHLED	42	49445 AZ, BA	142	49920 BK	145	330000 NI, OZ, PN	118
45685 NBRLED, PNLED	42	49475 RZ	139	49924 BKT	140	330001 BSS, MWH, OZ	118
45686 NBRLED, PNLED	33	49476 RZ	139	49925 BKT	140	330002 NI, OZ, WH	118
45801 CHLED	41	49492 AZ, PL, SBK	33, 134	49926 BKT	140	330010 NI, SBK	120
45838 CHLED, OZLED	41	49496 AZ, BA	142	49927 BKT	140	330025 BSS, SBK, WH	120
45839 CHLED, OZLED	41	49497 AZ, BA	142	49960 AVI	141	330100 NI, OBB, TZ, WH	124
45881 NI, OZ	39, 78	49550 AZLED, BKTLED	133	49961 AVI	141	330103 NI, OBB, OBBU, WH	124
45882 NI, OZ	52, 78	49551 AZLED, BKTLED	133	49962 AVI	141	330110 MWH, NI, OBB, TZ, WH	124
45883 NI, OZ	52, 78	49557 AZLED	132	49963 AVI	141	330171 MWH, NBR, NI, OZ, PN	119
45884 NI, OZ	52, 78	49558 AZLED	132	49965 AVI	141	330174 MWH, NBR, NI, OZ, PN	119
45885 NI, OZ	50, 77	49607 AZTLED	133	49980 BKT	143	330180 MWH, NBR, NI, OZ, PN	119
45886 NI, OZ	50, 77	49608 AZTLED	133	49981 BKT	143	330241 MWH, NI, OZ	121
45887 NI, OZ	50, 77	49622 BKTLED	136	49982 BKT	143	330242 MWH, NI, OZ	121
45888 NI, OZ	38, 76	49623 BKTLED	136	49991 GG, WH	143	330243 MWH, NI, OZ	121
45889 NI, OZ	48, 76	49624 BKTLED	136	49993 WH, GG	143	330247 BAP, MWH, NI, OBB	122
45890 NI, OZ	48, 76	49625 BKTLED	136	83260 NI	56	330248 BAP, MWH, NI, OBB	122
45891 NI, OZ	48, 76	49654 BK	147	83261 NI	56	339022 OBB, WH	123
45892 NI, OZ	38, 73	49655 BK	147	83452 SW	56	339211 AP, MWH, OBB, OZ, SNW	123
45893 NI, OZ	51, 73	49656 BK	147	83453 SB	56	339240 MWH, NI, OBB, TZ, WH	124
45894 NI, OZ	51, 73	49657 BK	147	83454 SW	56	339400 AP, MWH, OBB, OZ	123
45895 NI, OZ	51, 73	49686 OZ	137	83455 SB	56	339515 SBK, TZP, WH	128
45901 NI, OZ	82	49687 OZ	137	83490 CH	57	371042 MUL	129
45901 NI, OZ, NIL18, OZL18	37	49688 OZ	137	83492 CH	57	371045 MUL	129
45902 NI, OZ	82	49690 OZ	137	83493 CH	57	371082	129
45902 NI, OZ, NIL18, OZL18	47	49775 BA, BK	144	83670 NI	56	371085	129
45903 NI, OZ	82	49776 BA, BK	144	83671 NI	56	16067 AZT, BKT, CBR	204
45903 NI, OZ, NIL18, OZL18	47	49785 BKLED	134	83690 NI	57	16068 AZT, BKT, CBR	204
45904 NI, OZ	82	49786 BKLED	134	83728 NI	32	16069 AZT, BKT, CBR	204
45904 NI, OZ, NIL18, OZL18	47	49802 BKTLED, PLLED	132	83736 NI	40	FM127265	205
45910 NI, OZ	38, 77	49803 BKTLED, PLLED	132	83743 NI	40		
45921 NI, OZ	75	49820 BKT	141	83745 CH	32		
45921 NI, OZ, NIL18, OZL18	37	49821 BKT	141	83749 BZ	40		
45922 NI, OZ	75	49822 BKT	141	83750 NI	32		
45922 NI, OZ, NIL18, OZL18	46	49823 BKT	141	83752 NI	40		
45923 NI, OZ	75	49824 BK	143	83755 CH	32		
45923 NI, OZ, NIL18, OZL18	46	49825 BK	143	83756 NI	40		
45924 NI, OZ	75	49826 BK	143	83757 NI	32		
45924 NI, OZ, NIL18, OZL18	46	49827 BK	143	83759 NI	40		
45938 NI, OZ	83	49829 OZ	139	83760 CH	32		
45938 NI, OZ, NIL18, OZL18	37	49830 OZ	139	83791 CH	57		
45939 NI, OZ	83	49831 OZ	139	83792 CH	32		
45939 NI, OZ, NIL18, OZL18	47	49832 OZ	139	83799 NI	19		
45940 NI, OZ	83	49834 OZ	139	83802 BZ	19		
45940 NI, OZ, NIL18, OZL18	47	49837 BK	142	83803 NI	19		
		49840 OZ	147	83806 BZ	19		
		49841 OZ	147	83992	55		
		49842 OZ	147	83993	55		

# LEGEND/SYMBOL GUIDE

- (C) = Candelabra base lamp (E-12).
- (C/K) = Candelabra base lamp (E-12) or Krypton candelabra base lamp.
- (K) = Krypton candelabra base lamp.
- (M) = Medium base lamp (E-26).
- (MNCN) = Mini-can base halogen lamp
- ✓ = Fixture requires supply wire rated for at least 75° C.
- ❖ = Fixture requires supply wire rated for at least 90° C.
- ★ = When electrical connection is made inside the fixture, supply wire must be rated at least 75° C. When electrical connection is made in an outlet box, supply wire must be rated at least 60° C.
- ⓘ = Installation Instructions: Fixture must be supported independently of the outlet box unless the outlet box is UL Listed for the weight to be supported. Consult a qualified electrician/installer. Required installation parts included.
- D = Diameter
- Ext. = Extension
- Fluor. = Fluorescent
- H = Height
- HCWO = Height from Center of Wall Opening
- Incand. = Incandescent
- L = Length
- Ovrll. H = Overall Height
- W = Width

- Extra Wire = Extra wire beyond chain and/or stems
- Chain/Wire = Length of chain or stem supplied with fixture
- T24 = 2016 Title 24, Part 6 is a document that contains the California Building Energy Efficiency Standards for Residential and Non-residential Buildings as regulated by the California Energy Commission. Products marked with this logo and labeled as JA8-2016 or JA8-2016-E have been found to meet the requirements stated in 2016 Title 24, Part 6. For more information, visit [www.energy.ca.gov/title24](http://www.energy.ca.gov/title24).
- Ⓛ = LED Energy Efficient bulb included
- ♿ = ADA Compliant
- Ⓛ = CFL Lamp Included
- D = DAMP
- ☾ = Dark Sky Compliant
- 💡 = Incandescent Lamp included
- ⦿ = Integrated LED
- W = WET
- ENERGY STAR = Energy Star
- ★ = Kichler® products are not produced or associated with any Native American Indians, nor are they a Native American product or the product of a particular Indian, Indian tribe or Indian arts and crafts organization as defined by 25 U.S.C. §305 et. seq.



**DC MOTOR**  
CEILING FANS  
The ultimate in energy-efficient operation



**ENERGY STAR®**  
CEILING FANS  
The trusted, government-backed symbol for energy-efficient products



**LED LIGHT KIT**  
CEILING FANS  
Long life, replaceable bulbs that are extremely energy efficient



**DAMP-RATED**  
CEILING FANS  
Engineered for high-humidity areas



**WET-RATED**  
CEILING FANS  
For open or direct exposure to sun, rain or spray



**CLIMATES™**  
CEILING FANS  
Built to withstand open exposure to the harshest outdoor elements

- Bulbs not included unless otherwise noted.
- Wattages stated are the maximum recommended; however, you may use lower wattage lamps to suit your lighting needs. Some recommended lamps are not available in the maximum allowable wattage.
- All electrical products are rated as 120-volt, AC unless otherwise noted.
- All electrical products are certified and listed to UL/CSA/ETL Standards for use in U.S.A. and Canada except where noted.
- All chain drop products equipped with at least 72" of chain unless otherwise noted.
- All products featured in the outdoor section are certified and listed to UL/CSA/ETL standards for wet location except where noted.

- Many long life tungsten halogen capsule lamps are now available as alternates to conventional incandescent light bulbs. The halogen capsule lamps may be used to replace any lamp of a higher wattage, but not to exceed the existing specified maximum wattage, i.e., 72W may replace a 75W.
- On some products, in order to accommodate higher-than-normal ceiling height, extra lead wire is supplied and specified. With additional sections of chain or stems (not included), this allows an added measure of design flexibility.
- Finishes for fixtures installed outdoors are subject to change due to prolonged exposure to sunlight, airborne pollutants and other forms of weathering.
- To serve you better, Kichler® reserves the right to make improvements to the products in this catalog. Therefore, some products may change during the life of the catalog and the product information contained in this catalog may also have changed.

We go to great lengths to assure the metal and glass finishes shown in the catalog match the actual products, but printing variations and variations in chemical finishes and the nature of hand-applied finishing will cause some differences between the printed images and actual product, and from one product to another.

We use only non-ferrous materials on the exterior parts of our outdoor lantern products, and use the best available weather-resistant finishes. However, due to some extreme environmental conditions such as acid rain, salt air and ultraviolet exposure, we cannot guarantee our exterior finishes, with the exception of our LifeBrite® lanterns.

Due to environmental conditions such as soil acidity, concrete alkalinity and other corrosive soil and air conditions, we cannot guarantee our direct burial posts.

# ABBREVIATION KEY

<b>AB</b> Antique Brass	<b>CZ</b> Carré Bronze®	<b>SB</b> Sand Textured Black (élan finish)
<b>ABZ</b> Antique Bronze	<b>DBK</b> Distressed Black	<b>SBK</b> Satin Black
<b>AGZ</b> Aged Bronze	<b>DCO</b> Distressed Copper	<b>SC</b> Stucco White
<b>ALM</b> Almond	<b>ESP</b> Espresso	<b>SD</b> Sand
<b>AP</b> Antique Pewter	<b>GNT</b> Granite	<b>SEG</b> Satin-Etched Glass
<b>AVI</b> Anvil Iron	<b>GRY</b> Textured Gray	<b>SGD</b> Sterling Gold
<b>AZ</b> Architectural Bronze™	<b>LD</b> Londonderry™	<b>SI</b> Silver
<b>AZT</b> Textured Architectural Bronze™	<b>LZ</b> Legacy Bronze™	<b>SN</b> Satin Nickel
<b>BA</b> Brushed Aluminum	<b>MBK</b> Matte Black	<b>SNB</b> Satin Natural Bronze
<b>BAW</b> Brushed Aluminum with Wood Trim	<b>MBZ</b> Marbled Bronze	<b>SNBU</b> Satin Natural Bronze
<b>BAB</b> Burnished Antique Brass	<b>MCH</b> Midnight Chrome	<b>SNW</b> Satin Natural White
<b>BAP</b> Brushed Antique Pewter	<b>MIZ</b> Mission Bronze™	<b>SS</b> Stainless Steel
<b>BBR</b> Bronzed Brass	<b>MWH</b> Matte White	<b>SW</b> Sand Textured White (élan finish)
<b>BBZ</b> Burnished Bronze™	<b>NBR</b> Natural Brass	<b>SWZ</b> Shadow Bronze™
<b>BCZ</b> Burnished Copper Bronze	<b>NCH</b> Brushed Nickel and Polished Chrome	<b>TRZ</b> Terrene Bronze™
<b>BK</b> Black	<b>NI</b> Brushed Nickel	<b>TZ</b> Tannery Bronze™
<b>BKG</b> Black with Gold Highlights	<b>NIMER</b> Brushed Nickel with Mercury Glass	<b>TZG</b> Tannery Bronze™ with Gold Accents
<b>BKS</b> Black with Satin Etched Glass	<b>NIS</b> Brushed Nickel with Satin-Etched Glass	<b>TZP</b> Tannery Bronze™ with Polished Brass Accents
<b>BKT</b> Textured Black	<b>NISW</b> Brushed Nickel with Satin-Etched White Glass	<b>TZT</b> Textured Tannery Bronze
<b>BKZ</b> Berkshire Bronze™	<b>NIT</b> Textured Nickel	<b>WCP</b> Weathered Copper
<b>BN</b> Brushed Nickel	<b>NIW</b> Brushed Nickel with White Fabric Shade	<b>WSP</b> Weathered Steel
<b>BPT</b> Brushed Pewter	<b>OB</b> Olde Brick®	<b>WH</b> White
<b>BRZ</b> Brushed Bronze	<b>OBZ</b> Oil Brushed Bronze™	<b>WHT</b> Textured White
<b>BS</b> Burnished Silver	<b>OBBU</b> Oil Brushed Bronze™	<b>WZC</b> Weathered Zinc
<b>BSG</b> Burnished Silver and Gold	<b>OI</b> Olde Iron	
<b>BSS</b> Brushed Stainless Steel	<b>OLZ</b> Oiled Bronze	
<b>BST</b> Brown Stone	<b>ORZ</b> Oil Rubbed Bronze	
<b>BZ</b> Bronze	<b>OZ</b> Olde Bronze®	
<b>BZT</b> Textured Bronze	<b>OZCLR</b> Olde Bronze® with Clear Glass	
<b>CBR</b> Centennial Brass	<b>OZCP</b> Olde Bronze® with Light Champagne Glass	
<b>CH</b> Polished Chrome	<b>OZMER</b> Olde Bronze® with Mercury Glass	
<b>CHCLR</b> Chrome with Clear Glass	<b>OZS</b> Olde Bronze® with Satin-Etched Glass	
<b>CHS</b> Chrome with Satin Etched Glass	<b>OZW</b> Olde Bronze® with Satin-Etched White Glass	
<b>CHW</b> Polished Chrome with Satin-Etched White Glass	<b>PB</b> Polished Brass	
<b>CLP</b> Classic Pewter	<b>PC</b> Polished Chrome	
<b>CLR</b> Clear	<b>PL</b> Platinum	
<b>CMB</b> Cambridge	<b>PN</b> Polished Nickel	
<b>CMZ</b> Cambridge Bronze	<b>PPW</b> Polished Pewter	
<b>CO</b> Copper	<b>PR</b> Prairie Rock™	
<b>CP</b> Champagne	<b>PZ</b> Patina Bronze	
<b>CTZ</b> Colton Bronze™	<b>RST</b> Rustic™	
<b>CV</b> Canyon View™	<b>RVN</b> Ravenna™	
<b>CW</b> Crimson Wood	<b>RZ</b> Rubbed Bronze™	
	<b>RZS</b> Rubbed Bronze™ with Satin-Etched Glass	

## CONNECT WITH US



Like us: [facebook.com/Kichler.Lighting](https://www.facebook.com/Kichler.Lighting)

Follow us: [twitter.com/KichlerLight](https://twitter.com/KichlerLight)

Watch us: [youtube.com/KichlerLighting](https://www.youtube.com/KichlerLighting)

Join us: [houzz.com/pro/KichlerLighting/Kichler](https://www.houzz.com/pro/KichlerLighting/Kichler)

Find us: [pinterest.com/KichlerStyle](https://www.pinterest.com/KichlerStyle)

Follow us: [instagram.com/KichlerLighting](https://www.instagram.com/KichlerLighting)

To find an Authorized Dealer, visit [Kichler.com](http://Kichler.com)

## KICHLER

7711 E. Pleasant Valley Rd.  
PO Box 318010  
Cleveland, Ohio 44131-8010





## Our Vision

At Kichler Lighting, everything we do, every single day, is with the intention of creating and delivering products that allow people to see what matters most to them. We will do that by relentlessly pursuing quality, ensuring continued innovation, always going one step further in our commitment to exceptional customer service and education, as well as creating on-trend designs that are both stylish and “life-stylish,” promising to deliver project success for you.

Get inspired at [Kichler.com](https://www.kichler.com)

Featured on Front Cover: Ceiling Light 10765NILED, Wall Sconce 11315NILED | Pages 21, 35

Catalog No. K918REVA | Printed in USA, 17CM4588-15M | For more information call: 866-558-5706  
© 2019 Kichler Lighting LLC. All Rights Reserved. The majority of newer Kichler fixtures are U.S. Patent Pending.